

FUZZYSCAN WIRELESS IMAGER

Reference Manual

International Edition, Rev D8

cino

Revision History

Rev. No.	Released Date	Description
Rev. A	Oct 16, 2009	❖ First Release
Rev. A1	Oct 22, 2009	❖ Modified "Getting Started" - "Clone Function" operation method. ❖ Added "Appendix" - "Save Configuration" and "Master Default" System Commands.
Rev. A2	Nov 27, 2009	❖ Modified "Operation Control" - "Bluetooth Device Name". ❖ Add "Appendix" - "Indications".
Rev. A3	Mar 05, 2010	❖ Modify "Symbology Reading Control" - "UPC-A & UPC-E Setting" ❖ Modified "Serial Interface Control" – Renamed "Time Out Control" to "Serial Response Time-out". ❖ Modified "Operation Control" – "Operation Mode" - Renamed "Presentation Scanning Mode" to "Presentation Control". ❖ Modified "Operation Control" – "Rename "Auto Power Off Duration" to "Light Source On Time". ❖ Modified "Operation Control" – "Good Read Duration" ❖ Modified "Operation Control" – "Rename "Presentation Scanning Auto-sense" to "Presentation Auto-sense". ❖ Added "Operation Control" – "Presentation Sensitivity"
Rev. A4	Apr 27, 2010	❖ Modified "Serial Interface Control" – "Baud Rate(BPS)" ❖ Modified "Operation Control" – "Hands Free Time-out"
Rev. A5	Jun 28, 2010	❖ Added "Symbology Reading Control" - "UPC/EAN Security Level".
Rev. A5	Jun 28, 2010	❖ Added "Operation Control" – "Time Delay to Low Power Trigger" (Renamed to "Time Delay to Low Power Standby Mode" on Rev.C7) ❖ Added "Operation Control" – "Good Read Indicator". ❖ Modified "Operation Control" – "Scan Rate Control" – Added "Scan Voting"
Rev. A6	Sep 20, 2010	❖ Modify "Symbology Reading Control" - Renamed "Scan Voting" to "Supplement Scan Voting" ❖ Modify "Symbology Reading Control" – "EAN Setting" ❖ Modify "Keyboard Interface Control" – "Keyboard Layout (Language) Setting"

Revision History

Rev. No.	Released Date	Description
Rev. A6	Sep 20, 2010	<ul style="list-style-type: none"> ❖ Modified “Operation Control” – “Scan rate Control” ❖ Modified “Operation Control” – “Batch Data Quantity Output Format” (Renamed to “Stored Data Output format” on Rev. C7)
Rev. A7	Nov 10, 2010	<ul style="list-style-type: none"> ❖ Modified “Serial Interface Control” – “Baud Rate(BPS)”
Rev. A8	Jan 2, 2011	<ul style="list-style-type: none"> ❖ Modified “Operation Control” – “Buzzer Tone Adjust”
Rev. A9	Mar 4, 2011	<ul style="list-style-type: none"> ❖ Modified “Serial Interface Control” – “Baud Rate(BPS)”
Rev. B1	Mar 22, 2011	<ul style="list-style-type: none"> ❖ Modify “Symbology Reading Control” – “Code 39 Setting” ❖ Modified “Serial Interface Control” – “Protocol, ACK/NAK Setting”; Added “ACK/NAK Transmission Indication”.(Renamed to “ACK Indication” on Rev. B2) ❖ Added “Appendix” - “Numeric Bar Codes”.and “Connecting Apple iOS Devices Quick Sets” (Removed and modified to “Toggle between Barcode scanning and On-screen keyboard of mobile devices” on Rev.C7)
Rev. B2	Jul 22, 2011	<ul style="list-style-type: none"> ❖ Modify “Symbology Reading Control” – “User Defined symbol” ❖ Modified “Serial Interface Control” – “Protocol, ACK/NAK Setting”; Renamed “ACK/NAK Transmission Indication” to “ACK Indication” ❖ Modified “Serial Interface Control” – “Serial response time -out” ❖ Added “Operation Control” – “Laser Aiming Control” ❖ Modified “Condensed DataWizard” – “Select a Br Code Symbology”
Rev. B3	Nov 4, 2011	<ul style="list-style-type: none"> ❖ Modified “Getting Started” – “Paging/ Reset button” ❖ Modified “Symbology Reading Control” – “Codabar/NW-7 Setting”
Rev. B4	Jan 3, 2012	<ul style="list-style-type: none"> ❖ Modified “Wand/Laser Emulation Control” – “Code 39/Code 128 Emulation”
Rev. B5	Mar 5, 2012	<ul style="list-style-type: none"> ❖ Added “Condensed DataWizard” – “1D Barcode Forward-reading Indication”, “1D Barcode Backward-reading Indication”, and “1D Barcode Direction Indication Transmission”

Revision History

Rev. No.	Released Date	Description
Rev. B6	Jul 25, 2012	<ul style="list-style-type: none"> ❖ Modified “Host Interface Selection” ❖ Modified “Symbology Reading Control” – “ Code 128 Setting” ❖ Modified “Wand/Laser Emulation Control” – “ Code 39/Code 128 Emulation” ❖ Added “Operation Control” – “LED illumination Control” and “LED Illumination Delay”
Rev. B7	Aug 20, 2013	<ul style="list-style-type: none"> ❖ Modified “Symbology Reading Control” – “Readable Bar Code Setting” section” ❖ Modified “ Appendix” - “Symbology ID Table”
Rev. C1	Jan 15, 2014	<ul style="list-style-type: none"> ❖ Supported 2D Functions ❖ Modified “Getting Started” – “ Preparation before Using”, “ Use FuzzyScan in HID Mode”, and “Batch Scanning” ❖ Added “Getting Started” – “Sleep Mode” and “Power Off”
	Jan 23, 2014	<ul style="list-style-type: none"> ❖ Modified “Operation Control” – “Presentation Sensitivity”
Rev. C2	May 8, 2014	<ul style="list-style-type: none"> ❖ Support 1D Pocket Scanner ❖ Added “Host Interface Selection” - “USB EFT Terminal Mode” ❖ Added “Appendix” - “USB HID Legacy Mode” Host Interface and “Abort” Option Codes Quick Set Command
Rev. C3	May 9, 2014	<ul style="list-style-type: none"> ❖ Added “Getting Started” – “Clear All Scanned Data” Command.
Rev. C4	Feb. 6, 2015	<ul style="list-style-type: none"> ❖ Added “Symbology Reading Control” – “ MaxiCode Setting”
Rev. C5	Mar. 9, 2015	<ul style="list-style-type: none"> ❖ Added “Getting Started” – “Paging Function” ❖ Added “Operation Control” – “ Radio Connection Beeps”, “HID Mode Transmit Delay” and “Link Quality Control”
Rev. C6	Jun. 3, 2015	<ul style="list-style-type: none"> ❖ Modified “Operation Control” – “ Good Read Duration” ❖ Modified “ Appendix” - “ Uninstall” Quick Set

Revision History

Rev. No.	Released Date	Description
Rev. C7	Sep. 9, 2015	<ul style="list-style-type: none"> ❖ Supported 2D Pocket Scanner ❖ Added “Getting Started” – “ Using the Function Keys of Pocket Scanner”, “ Enter Bluetooth Discoverable Mode”, “How to Delete Last Scanned Data”, “Toggle between Barcode Scanning and On-screen Keyboard input”, “ Check Battery Status” and “Battery Status Indication” ❖ Modified “Getting Started” – “ Power Off” and “How to Transmit Stored Data” ❖ Added “Operation Control” – “Buzzer Volume”, “Timestamp Functions”, 2D “Stored Data Output Format”, “Radio Link Mode for Discoverable Mode” and “Low Power Stand-by mode Link Indication” ❖ Renamed “Operation Control” – “Time Delay Low Power Trigger” to “Time Delay to Low Power Standby Mode” ❖ Removed “Operation Control” – “Link Supervision Time Out” ❖ Renamed “Operation Control” – “Sleep Time-out Control” to “Radio-off Time-out Control”; ❖ Modified “Operation Control” – “HID Mode Transmit Delay”. “Good Read Duration” and “Time Delay to Low Power Standby Mode” ❖ Modified “Operation Control” – “Radio-off Time-out Control, Power Off Time-out Control” ❖ Renamed “Operation Control” – “Batch Data Quantity Output Format” to “Stored Data Output Format” ❖ Renamed “Operation Control” – “Bluetooth Power Saving Mode” to “Bluetooth Sniff Control”; Enable Bluetooth Sniff Control. ❖ Modified “Operation Control” – “Link Quality Control” ❖ Added “Operation Control” – “On-screen Keyboard Control” ❖ Modified “Appendix” – “Toggle between Barcode Scanning and On-screen Keyboard input” ❖ Removed “Appendix” – “Sleep” system command
Rev. C8	Dec. 23, 2015	<ul style="list-style-type: none"> ❖ Updated “Revision History” ❖ Modified “Getting Started” – “ Toggle between Barcode Scanning and On-screen Keyboard input” ❖ Added “Operation Control” – available firmware information for optimized Bluetooth operation behaviors.

Revision History

Rev. No.	Released Date	Description
Rev. C9	Mar. 17, 2016	<ul style="list-style-type: none"> ❖ Added "Getting Started" -A670BT series scanner ❖ Modified "Operation Control" – available firmware information for optimized Bluetooth operation behaviors.
Rev. C10	May. 31, 2016	<ul style="list-style-type: none"> ❖ Modified "Operation Control" – "Timestamp Functions"
Rev. C11	Aug. 04, 2016	<ul style="list-style-type: none"> ❖ Added "Symbology Reading Control" – "Small DM Code Reading"
Rev. C12	Oct. 7, 2016	<ul style="list-style-type: none"> ❖ Modified "Appendix" – "Keyboard Function Code Table"
Rev. C13	Mar. 9, 2017	<ul style="list-style-type: none"> ❖ Modified "Appendix" – "Scanner Indication" ❖ Modified "Operation Control" – "Buzzer Tone Adjust" ❖ Moved "Dollar Sign control" from "Operation Control" to "Keyboard Interface Control".
Rev. C14	Aug. 3, 2017	<ul style="list-style-type: none"> ❖ Added "Getting Started" – "Validation Scanning" ❖ Modified "Getting Started" – "Using the Function Keys of Pocket Scanner" ❖ Added "Operation Control" – "Validation Scanning" ❖ Added "Operation Control" – "FN2 Function Mode"
Rev. C15	Mar. 2, 2018	<ul style="list-style-type: none"> ❖ Added new released model "A780BT" and "A680BT" ❖ Modified "Symbology Reading Control" – "Readable Symbology Setting" – "Popular 1D" ❖ Modified "Getting Familiar with Your FuzzyScan" - A780BT and A680BT series scanner ❖ Modified "Preparation before Using" – "Charging the Battery"
Rev. C16	Sep. 20, 2018	<ul style="list-style-type: none"> ❖ Added "Operation Control" - "Motion Control" ❖ Modified the description of "Symbology Reading Control" – "UPC/EAN Security Level" ❖ Added information on Code Pages ❖ Modified "Radio-off Time-out - Disconnect State" parameter information ❖ Modified notes on Unique Barcode Reporting

Revision History

Rev. No.	Released Date	Description
Rev. C17	Nov. 22, 2018	❖ Improved “Symbology Reading Control” – “Code 128 Setting ISBT” - ISBT Concatenation settings
Rev. C18	Mar. 21, 2019	<ul style="list-style-type: none"> ❖ Modified “Symbology Reading Control” – “QR Code Setting” – “Auto detect QR Code Inverse Reading” ❖ Modified “Operation Control” – “Motion Control”. Redefined “Motion Control” as “Scene Mode”. ❖ Removed “Operation Control” – “Bluetooth Sniff Control”
Rev. C19	Jun. 11, 2019	<ul style="list-style-type: none"> ❖ Added “Getting Started” – “Preparation before Use – Smart Dongle” ❖ Added “Getting Started” – “Pairing Bluetooth Imager with Dongle”
Rev. D1	Oct. 21, 2019	<ul style="list-style-type: none"> ❖ Added “Getting Started” – “ Getting Familiar with Your FuzzyScan Scanners” ❖ Added “Getting Started” – “Preparation before Use” ❖ Added “Getting Started” – “Using Scanner in PAIR Mode” ❖ Added “Getting Started” – “Using Scanner in PICO Mode” ❖ Added “Getting Started” – “Using Scanner in SPP Mode” ❖ Added “ECI ID Output” ❖ Added new model A660BT ❖ Added “SPP Master Simple Mode” ❖ Added “SPP Slave Simple Mode” ❖ Removed “Bluetooth Authentication”
Rev. D2	Nov. 28, 2019	<ul style="list-style-type: none"> ❖ Added “Serial Port Output” ❖ Added “Keyboard Layout Setting” - “Alt-Code Keyboard” input

Revision History

Rev. No.	Released Date	Description
Rev. D3	Mar. 20, 2020	<ul style="list-style-type: none"> ❖ Added “Using Scanner in SPP Mode” – “Auto Reconnection On/Off under SPP Slave Mode” ❖ Renamed “Keyboard Layout Setting” - “Alt-Code Keyboard” to “Universal” ❖ “Keyboard Interface Control” – “Function Key Emulation”: <ul style="list-style-type: none"> ❖ Renamed option “Enable ASCII 00-31 code as keyboard function code output” to “Enable Keyboard Function Code Table 1 Output” ❖ Renamed option “Ctrl-Output” to “Enable Keyboard Function Code Table 2 Output” ❖ Added option “Enable Keyboard Function Code Table 3 Output” ❖ Modified “Appendix” – “Keyboard Function Control Table”: <ul style="list-style-type: none"> ❖ Renamed column title “Key Function” to “Key Function 1” ❖ Renamed column title “Ctrl-Output” to “Key Function 2” ❖ Added column “Key Function 3”
Rev D4	May 27, 2020	<ul style="list-style-type: none"> ❖ Modified “Symbology Reading Control” – “Small DM Code Reading” to “Damaged DM Code Reading”. ❖ Modified “Operation Control” – “Operation Mode” <ul style="list-style-type: none"> ❖ Added option “Multiple Read Mode”
Rev D5	Aug, 14, 2020	<ul style="list-style-type: none"> ❖ “Symbology Reading Control” – “QR Code Setting” <ul style="list-style-type: none"> ❖ Added function option “QR Code Mirror Images”
Rev D6	April 23, 2021	<ul style="list-style-type: none"> ❖ Added supported model: PA680BT ❖ “Symbology Reading Control” – GS1-128 Setting: <ul style="list-style-type: none"> ❖ Added “GS1-128 Function Control”, “GS1-128 FNC1 Setting”, “GS1-128 Element String Separator”, “GS1-128 Data Separator“, “GS1-128 Error Converting” ❖ Added “Operation Control” – “Bluetooth Sniff Control” ❖ “Keyboard Interface Control” – “Keyboard Output”: ” Added option “Linux Unicode Output” ❖ “Aiming Control”- Removed option “Intelligent Aiming” ❖ Modified “Operation Control” – “Redundancy”. Applied to F&L Series only
Rev D7	Sep.13, 2022	<ul style="list-style-type: none"> ❖ Modified “Operation Control” – “Operation Mode”

- ❖ Correct option code of “Multiple Read Mode”
- ❖ Modified “**Getting Started**” –“Using FuzzyScan in PAIR Mode“
 - ❖ Revise the default setting of “ Pair Mode” from “locked pair mode” to “unlocked pair mode”
- ❖ Modified “**Getting Started**”–“Pairing Bluetooth Imager with Dongle”.
 - ❖ Revise the default setting of “ Pair Mode” from “locked pair mode” to “unlocked pair mode”
- ❖ Modified “**Operation Control**” –“Bluetooth Sniff Control”
 - ❖ Revise the default setting of “Bluetooth Sniff Control” from ”Enable” to “Disable”.

© Copyright PC Worth Int'l Co., Ltd

Cino makes no warranty of any kind with regard to this publication, including, but not limited to, the implied warranty of merchantability and fitness for any particular purpose. Cino shall not be liable for errors contained herein or for incidental consequential damages in connection with the furnishing, performance, or use of this publication. This publication contains proprietary information that is protected by copyright. All rights are reserved. No part of this publication may be photocopied, reproduced or translated into any language, in any forms, in an electronic retrieval system or otherwise, without prior written permission of Cino. All product information and specifications shown in this document may be changed without prior notice.

Warranty

Cino warrants its products against defects in workmanship and materials from the date of shipment, provided that the product is operated under normal and proper conditions. The warranty provisions and durations are furnished by different warranty programs. The above warranty does not apply to any product which has been (i) misused; (ii) damaged by accident or negligence; (iii) modified or altered by the purchaser or other party; (iv) repaired or tampered by unauthorized representatives; (v) operated or stored beyond the specified operational and environmental parameters; (vi) applied software, accessories or parts are not supplied by Cino; (vii) damaged by circumstances out of Cino's control, such as, but not limited to, lightning or fluctuation in electrical power. Any defective product must follow the warranty program and RMA procedures to return Cino for inspection.

Regulatory



FCC part 15B, FCC part 15C



EN61000-6-2, EN61000-6-3, EN60950-1, EN301 489-1, EN301 489-17, EN300 328 EN55022, EN55024



CNS13438, CNS14336



AS/NZS CISPR 22 Class B



Clause 2, Article 58-2 of Radio Waves Act



Class B ITE



LP0002

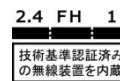

MIC T401

LED Eye Safety

IEC62471 Exempt group

Laser Eye Safety

IEC60825-1 Class 1

Table of Contents

GETTING STARTED.....	1
Getting Familiar with Your FuzzyScan Scanners.....	1
Preparation before Use – Pistol Type Scanners.....	5
Preparation before Use – Pocket Scanners	7
Preparation before Use – Smart Dongle	8
Decide Your Radio Link Mode	9
Using FuzzyScan in PAIR Mode.....	10
Using Scanner in PICO Mode.....	14
Using Scanner in HID Mode	18
Using Scanner in SPP Mode	19
Pairing Bluetooth Imager with Dongle	23
Enter Bluetooth Discoverable Mode	26
Out-of-range Scanning	26
Power Off the Scanner	26
Batch Scanning Mode (Inventory Mode)	27
Validation Scanning Mode	30
Toggle between Barcode Scanning and On-screen Keyboard Input.....	33
Presentation Scanning	33
Check Battery Status	34
Battery Status Indication	34
Paging Function.....	34



CONFIGURING YOUR SCANNER	35
Configuration Barcode Menu	35
Programming Procedures.....	36
Host Interface Selection.....	40
Symbology Reading Control	41
User Defined Symbol ID	41
Symbology ID Transmission	43
ECI ID Output.....	44
Readable Bar Code Setting	45
Code 39/Code 32 Setting.....	47
Codabar/NW-7 Setting	49
UPC-A & UPC-E Setting	51
EAN Setting.....	53
UCC Coupon Extended Code Setting.....	55
IATA & Interleaved 2 of 5 Setting	56
Code 25 Family Setting.....	57
Code 11 & Code 93 Setting	58
MSI/Plessey Setting.....	59
Code 128 Setting	60
GS1-128 Setting.....	61
UK/Plessey Setting	63
Telepen Setting	64
GS1 DataBar Setting.....	65

Composite Codes, Codablock F, & PDF417/MicroPDF417 Setting	66
Code 16K & Code 49 Setting	67
QR Code Setting	68
Data Matrix Setting	69
MaxiCode Setting	70
Aztec Code Setting	71
Australian Post, US Planet, US Postnet, British Post & Japan Post Setting	72
Netherlands KIX Code, Intelligent Mail & Korea Post Code Setting	73
Keyboard Interface Control	74
Keyboard Layout (Language) Setting	74
Record Suffix, Preamble, Postamble, & FNC1 Symbol Character Transmit	75
Caps Lock & Caps Lock Release Control	76
Delay Setting	77
Function Key & Key Pad Emulation, Upper/Lower Case & Dollar Sign Control	78
Code Page: Barcode Encoding Format, Keyboard Output	79
Serial Interface Control	82
Record Suffix, Preamble, Postamble Setting	82
Delay Setting	83
Protocol, ACK/NAK Setting	84
Time Out Setting, Baud Rate, Data Frame	85
Code Page: Barcode Encoding Format, Serial Port Output	86
Wand/Laser Emulation Control	89
Output Polarity, Signal State, Margin/Module Time	89

Code 39/Code 128 Emulation.....	90
Operation Control	91
Operation Mode	91
Batch Reading.....	92
Buzzer, Indicator, Vibrator, 1D Code Inverse Reading	96
Beeping Control, Radio Connection Beeps	97
Buzzer Volume	98
Timestamp Functions.....	99
Radio Link Mode for Discoverable Mode	101
Redundancy	102
Delay Setting.....	103
Light Source & Hand Free Time-out Setting, Good Read Duration.....	104
Low Power Standby Mode Settings	105
Presentation Scanning Setting.....	106
Scan Rate Control.....	107
Smart Scene	108
SmartStand Power Off Timeout, Laser Aiming Control, LED Illumination Control & Delay	109
Illumination Control, Presentation Background Lighting Control	110
Aiming Control, Pre Decode Aiming Timer, Decode Aiming Control.....	111
Center Alignment, Unique Barcode Reporting.....	112
Out-of-range Scanning.....	113
Radio-off Time-out & Power Off Time-out Control	114
FN2 Function Mode Setting	115

Batch Scanning Setting.....	116
Batch Scanning Data Transmission Setting.....	117
Validation Scanning Setting	118
Bluetooth: Device Name & PIN Code Setting.....	119
Bluetooth: Other Settings.....	120
On-screen Keyboard Control	121
Condensed DataWizard.....	122
Preamble, Postamble, Data Length & Symbol ID Transmission.....	122
Data Formatter Setting.....	123
Data Verifier Setting	124
Data Replacer Setting.....	125
Data Organizer Setting.....	126
Select a Barcode Symbology.....	127
Application Example.....	128
Programming Procedure	128
APPENDIX	130
Symbology ID Table	131
Keyboard Function Code Table	133
Code Page – Table of Corresponding Languages.....	135
Code Page – Unicode Hex Input Setup.....	136
ASCII Input Shortcut.....	140
Link Mode Quick Set Commands	141
Host Interface Quick Set Commands	142



Option Codes	143
System Commands	144
Indications.....	145



GETTING STARTED

Getting Familiar with Your FuzzyScan Scanners

Thank you for choosing Cino FuzzyScan Bluetooth Cordless Image Scanner. Powered by the combination of cutting-edge FuzzyScan Imaging Technology and Bluetooth wireless technology, it not only provides outstanding reading performance, but also delivers the convenience and freedom of mobility. It's ideal for a broad range of applications to unleash your productivity with ease. This document provides a quick reference for installation and operation. The complete documentation is available at www.cino.com.tw.

A780BT Series

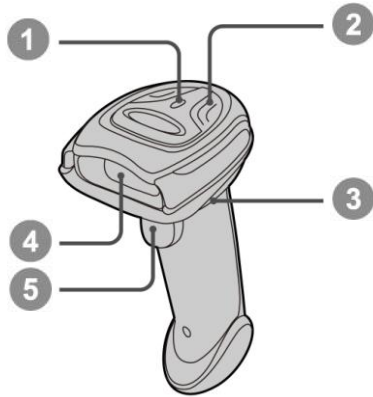

A680BT Series

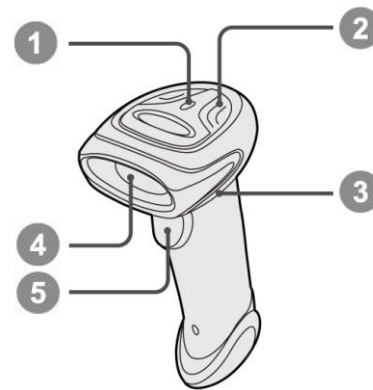

A770BT Series

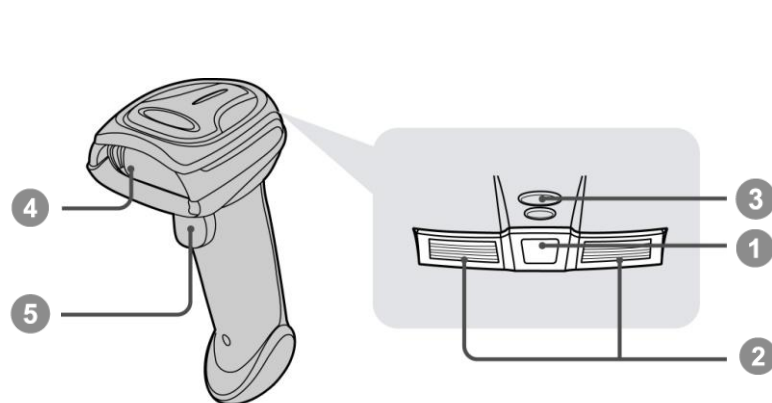

A660BT, A670BT, F680BT & L680BT

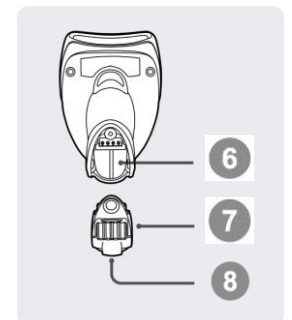
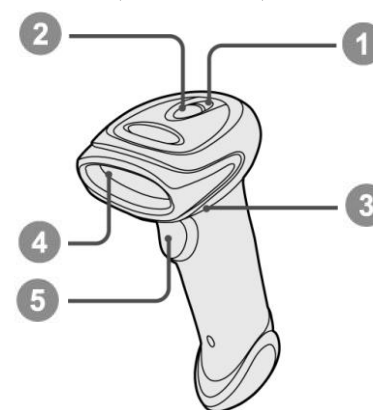



F780BT & L780BT

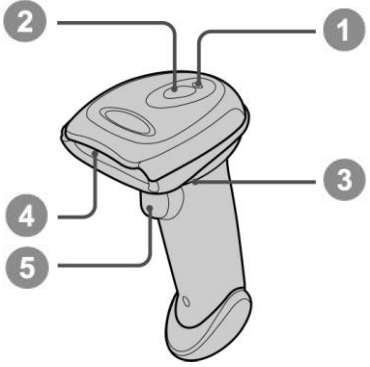

- 1 Link Indicator
- 2 Status Indicator
- 3 Beeper
- 4 Scan Window
- 5 Trigger
- 6 Battery Cavity
- 7 End Cap
- 8 Reset Key

HB2112 Smart Cradle

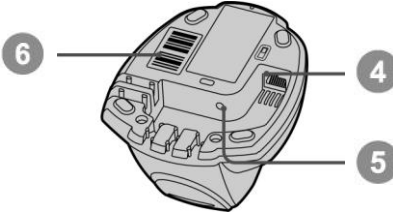
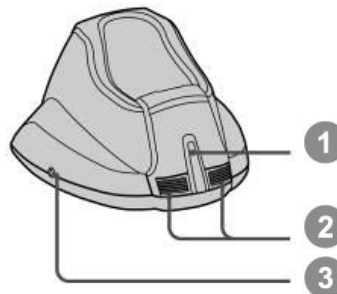

- 1 Central Indicator
- 2 Side Indicators
- 3 Paging/Reset Button
- 4 Host Interface Port
- 5 DC Power Jack
- 6 Quick Pair Barcode

HB2100 USB Charging Cradle

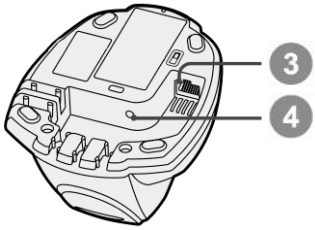
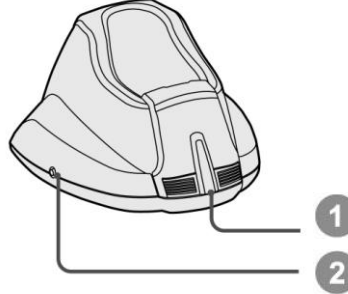

- 1 Central Power Indicator
- 2 Reserved
- 3 USB Port
- 4 DC Power Jack



PA680BT, PF680BT, and PL680BT

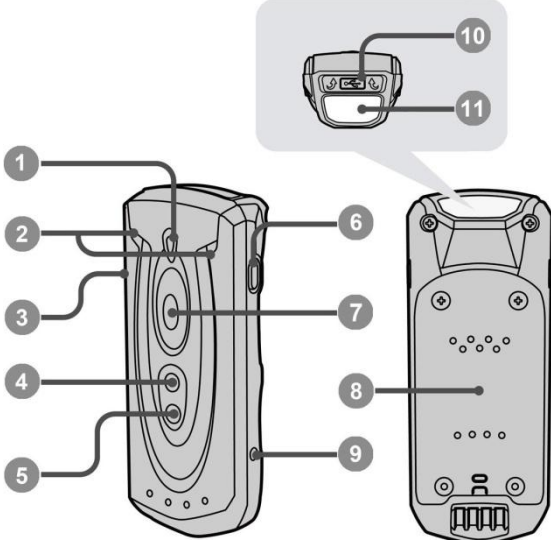

- 1 Status Indicator
- 2 Power/Link Indicators
- 3 Left Key
- 4 Function Key 1
- 5 Function Key 2
- 6 Right Key
- 7 Trigger
- 8 Battery Cover
- 9 Reset Key
- 10 Micro USB Port
- 11 Scan Window

HB3112 Smart Cradle

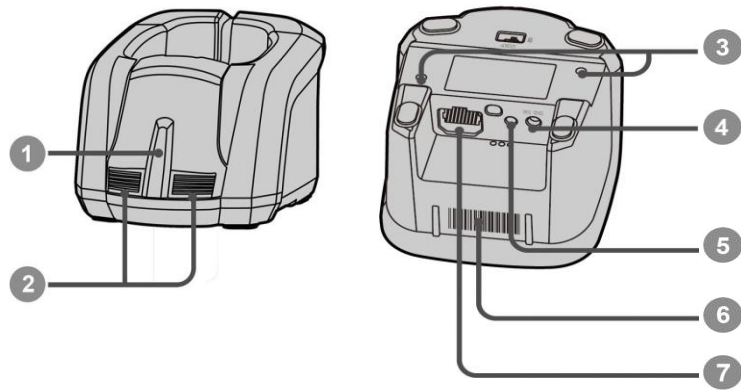

- 1 Central Indicator
- 2 Side Indicators (HB3112 only)
- 3 Mounting Holes
- 4 DC Power Jack
- 5 Paging/Reset Key
- 6 Quick Pair Barcode
- 7 Host Interface Port (HB3112)
USB Interface Port (HB3100)

Using the Function Keys of Pocket Scanner:

Function Keys	Functions	Actions
Left Key	Check battery status	Short press the key
	Transmit stored batch data	Long press the key
Right Key	Power off the scanner	Long press the key
Function Key 1	On-screen keyboard toggle	Short press the key
	Enter Bluetooth discovery mode	Long press the key
Function Key 2	Delete last scanned data (batch scanning)	Short press the key
	Enter batch scanning (inventory mode)	Long press the key
	Register Master Data (Validation Scanning)	Short press the key
	Enter Validation Scanning (Validation Scanning)	Long Press the key



Short Press: Press the key for less than 1 second.

Long Press: Press and hold the key for more than 3 seconds.



The Batch Scanning (Inventory Mode) is set as the default function mode, if you want to use the Function Key to carry out Validation Scanning, you have to change the “FN2 Function Mode” setting.

SD112 Smart Dongle

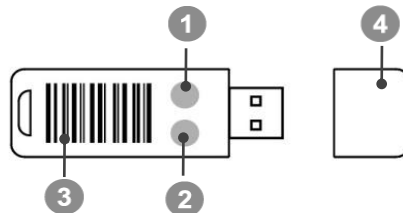

- 1 Status Indicator
- 2 Power/Pairing Indicator
- 3 Quick Pair Barcode
- 4 Cap



Preparation before Use - Pistol Type Scanners

Install the Battery

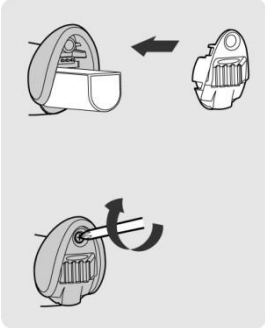

- 1 Ensure the battery contacts of the battery pack are facing the charging contacts inside the battery cavity.
- 2 Slide the battery pack into the battery cavity until hearing a click sound. Press the trigger to power on. The scanner will give 4 beeps when the battery pack is installed properly and if the battery pack still has power.
- 3 Secure the end cap with the screw provided.

Charging the Battery

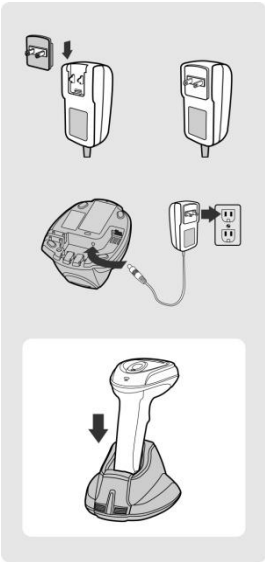

- 1 Choose the right plug and slot it into the power supply unit cavity until a “click” is heard. Then plug the power supply unit into the wall outlet.
- 2 Plug the DC power cord of power supply unit into the DC Jack of the cradle. The smart cradle will emit four beeps and the central indicator **blinks blue once** and side indicators **lights red**. If you use the charging cradle, the central indicator **lights blue**.
- 3 Place the scanner on the cradle. The status indicator of scanner turns **steady red** if the battery is not fully charged. When the battery is fully charged, the status indicator will be **steady green**.

 **Please charge the new battery pack for 8 hours before its first use.**

Use USB Bus Power

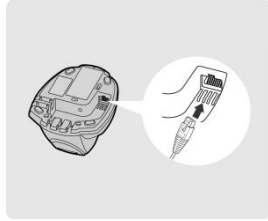

- 1 If **USB 3.0** is available in your host device, both battery charging and regular operation can be supported by the USB bus power without using external power supply.
- 2 If only **USB 2.0** is available in your host device, we recommend using external power supply as power source, because the power supplied from USB 2.0 is not enough to support both battery charging and regular operation simultaneously.

Preparation before Use - Pocket Scanners

Install the Battery

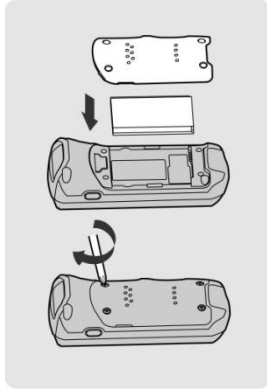

- ① Take off the battery cover from the scanner by removing two blue tapes.
- ② Make sure the battery contacts of the battery pack are facing the charging contacts inside the battery cavity. Then put the battery pack into the battery cavity carefully.
- ③ Place the battery cover in the right orientation onto the back of the scanner. Screw in and tighten the four shipped M2 screws in sequence by a small screw-driver in the clockwise direction.

Charging the Battery via Power Supply Unit

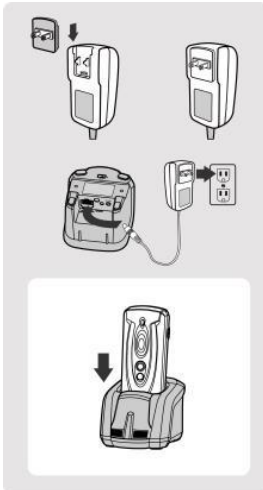

- ① Choose the right plug and slot it into the power supply unit cavity until a “click” is heard. Then plug the power supply unit into the wall outlet
- ② Plug the DC connector of the power supply unit into the DC Jack of the cradle. The cradle emits four beeps. For the smart cradle, the central indicator **blinks blue once** and side indicators **lights red**. For the charging cradle, the central indicator lights **blue**.
- ③ Place the scanner onto the cradle. The scanner’s status indicator will be **steady red** if the battery is not fully charged. When the battery is fully charged, the status indicator will be **steady green**.

Charge the Battery via USB 3.0 Port

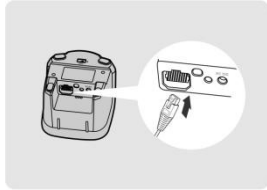

The scanner can also be charged via the USB 3.0 port without the power supply unit. Connect the cradle to USB 3.0 port of host device by a USB cable.

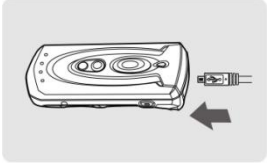

The scanner can also be charged via its micro USB port by connecting the micro USB cable to USB 3.0 port of host device or the commercial USB power adapter connected to the AC outlet.

Preparation before Use - Smart Dongle

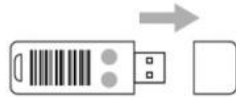

- 1 Remove the dongle cap
- 2 Plug the dongle into your host device's USB port.



- 3 Supply power to the dongle by turning on your host device. The power/pairing indicator will flash blue once and its status indicator will emit alternating red-green flashes ("unpaired state") when powered on.

Decide Your Radio Link Mode

The FuzzyScan Bluetooth image scanner provides several radio link modes to communicate with most host devices. When the Bluetooth-enabled host device is not available, it can work with the smart cradle in PAIR mode (peer-to-peer connection) or PICO mode (multiple connections) to provide a **plug-and-play** cordless migration of your existing non-Bluetooth-enabled devices. Moreover, you can also use the scanner to work with Bluetooth-enabled host devices via SPP mode or HID mode.

When the radio link is disconnected, the scanner is capable of reconnecting automatically when it returns to the communication coverage. If you want to change the radio link mode, please scan the “Uninstall” command to reset the scanner to uninstall state.

PAIR Mode

If the Bluetooth device is not available in your existing system, PAIR mode is the simplest plug-and-play solution. In this mode, a smart cradle can only work with one scanner. The smart cradle not only provides the Bluetooth radio link with the scanner, but also offers the legacy cabled interfaces to the host device, including USB HID, USB COM and RS232 Serial.

PICO Mode

For the requirement of multiple connections, up to 7 scanners can be connected to one smart cradle concurrently. If you want to un-pair all scanners paired with the smart cradle, please press and hold the paging/reset button of the smart cradle for more than 5 seconds. If you just want to un-pair part of the paired scanners, please take those paired scanners to scan the “Uninstall” command one by one.

HID Mode

Through the most useful HID service, the scanner can work as a **Bluetooth Keyboard**. In this mode, the scanner will be discoverable by the radio connection request issued by the remote host device.

SPP Master/Slave Mode

Through the standard SPP profile, the scanner can work as a Bluetooth Serial Device. In SPP master mode, the scanner initiates the radio connection request to the remote slave device. In SPP slave mode, the scanner will be discoverable by the radio connection request issued by the remote host device. Once the SPP slave pairing process is completed, the radio link mode will be switched to SPP master automatically. This behavior will enable the auto-reconnection feature when connection is lost

Using FuzzyScan in PAIR Mode

- 1 Using a suitable interface cable, connect the smart cradle to your host device. Turn on your host device. Make sure the smart cradle is receiving power, in which case, its LED lights will be on.

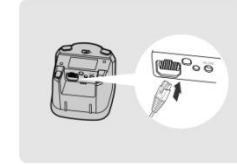
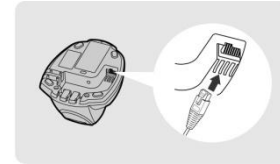
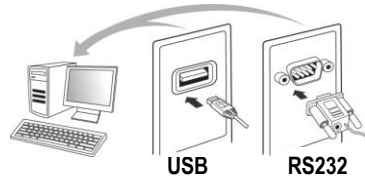

- 2 Power on the scanner and keep it well within your smart cradle's Bluetooth range during the entire pairing process.
- 3 Please note that if the scanner is shipped together with a smart cradle, they are pre-paired already. You will see the link indicator of scanner gives 1 blue blink per 2.5 seconds and the central indicator of smart cradle turns steady blue. If the scanner and smart cradle just give **alternative red and green blinks** (in "Uninstall" state), please follow step 4 to establish the connection between scanner and smart cradle.



Uninstall

- 4 Scan the smart cradle's Quick Pair Barcode with your scanner. This will launch the pairing process during which the scanner will emit a series of clicking sounds, and its link indicator will flash blue rapidly. Once pairing is completed, the scanner will beep 4 times in ascending tone, and its link indicator will **flash blue every 2.5 seconds**. The smart cradle's center indicator will be **steady blue**.

- 5 If the pairing process failed, the clicking sounds will stop and the scanner's link indicator will give **3 blue blinks every 2 seconds**. Thereafter, the scanner will continue to search for the smart cradle for another 30 seconds before going into "**Radio-Off**" state. In the interim, you may scan the "**Uninstall**" command to set the scanner to the "Uninstall" state. If the scanner has entered radio-off state already, you can wake it up by pressing its trigger; this will also cause the scanner to re-attempt pairing.
- 6 Scan the corresponding host interface quick set command to complete the installation.

The default host interface of smart cradle is preset to **USB HID**. If you want to set the host interface to **USB COM**, you have to install the USB virtual COM driver into your host device before using the scanner. Please visit CINO website to download the driver.



Locked Pair Mode

When your scanner is paired with Smart Cradle under PAIR mode, they become “unlocked” by default. You do not need to uninstall an unlocked PAIR before pairing another scanner with the cradle. You can also create a “locked” PAIR mode by scanning the “**Locked Pair Mode**” barcode before pairing. The cradle can be paired with any other scanner only if the current pairing is uninstalled.

To revert back to default “unlocked” mode afterwards, scan the **Unlocked Pair Mode** barcode before pairing.



Unlocked Pair Mode◆



Locked Pair Mode

Unpair Scanner from Smart Cradle

To unpair a scanner from its smart cradle: (a) scan the Uninstall barcode with the scanner, or (b) press and hold the smart cradle’s reset button for 5 seconds.



Uninstall

If unpairing is successful, both devices will flash red and green lights to reflect their unpaired state.

Override a Pairing under PAIR mode

- 1 As mentioned, when the scanner and smart cradle are paired under PAIR mode, they become “locked” by default and can no longer be paired with other scanners unless the pair is uninstalled in advance.
- 2 If you want to override the pairing without uninstalling it first, you can scan “Override the locked scanner” before pairing. This will override the current pairing and pair new scanner with the smart cradle..



Override the locked scanner



Smart Dongle does not reset button, this feature can be very useful when the paired scanner is lost, broken, or unknown (e.g. there are multiple scanners in use, and checking them individually to see which one is paired would be inefficient).

Creating a Barcode for PAIR Mode

Under PAIR mode, only one imager can be paired with the smart dongle. The original Quick Pair barcode on the smart dongle is for PAIR mode. To create a back up pairing barcode under this mode, please follow the instructions below.

- 1 Pair your dongle with an imager using the Quick Pair barcode.
- 2 Thereafter, scan the “System Information” command barcode. The dongle’s MAC addresses will be displayed on your host device.



SYSTEM INFORMATION

- 3 Use your barcode generator to create a pairing barcode for PAIR mode. The barcode’s symbology should be Code 128, and its format ought to be as follows:
`<Fnc 3>Pxxxxxx`
- 4 P is the prefix. xxxxxx represents the last 6 characters of the smart dongle’s MAC address
 For example, if the dongle’s MAC address is “00 25 14 11 11 11”, the pairing barcode will be: P111111

Using Scanner in PICO Mode

- 1 Create a Quick Pair barcode for PICO mode and have it ready. Please refer to next section for instructions on how to prepare such a barcode.
- 2 Using a suitable interface cable, connect the smart cradle to your host device.

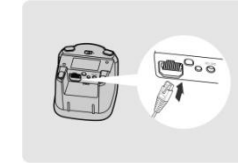
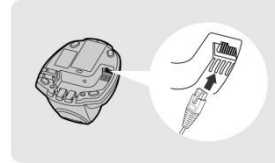
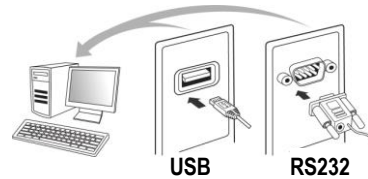

- 3 Turn on your host device. Make sure the smart cradle is receiving power, in which case, its LED lights will be on.
- 4 Power on the scanner, and be sure to keep it well within your smart cradle's Bluetooth range during the entire pairing process.
- 5 Prior to pairing, the scanner should be in an unpaired state, flashing red and green lights. If not, scan the Uninstall barcode to release it from any current pairing.





Uninstall

- 6 Prior to the **first** scanner pairing under PICO mode, your smart cradle should be in an unpaired state with its side indicators flashing red and green lights. If that's not the case, press and hold the smart cradle's paging/reset button for 5 seconds to release all current pairings. This is not applicable to **subsequent** pairings of course.
- 7 Thereafter, scan the smart cradle's Quick Pair barcode for PICO mode (which you have created in advance) with your scanner. This will launch the pairing process during which the scanner will emit a series of clicking sounds, and its link indicator will flash blue rapidly. Once pairing is completed, the scanner will beep 4 times in ascending tone, and its link indicator will flash blue every 2.5 seconds. The smart cradle's center indicator will be a steady blue.

- 8 Once pairing is completed, the scanner will beep 4 times in ascending tone, and its link indicator will flash blue every 2.5 seconds. As for the smart cradle, its center indicator will display a steady blue light and its side indicators will be steady green.

As applicable, repeat the above procedures to pair other scanners with the same smart cradle (up to 7 scanners).

-  The smart cradle's default host interface setting is USB HID, which is plug-and-play and works with host devices running Windows, Linux, or Mac OS. This interface setting may be changed to RS232 or USB COM if needed. See notes below for further details and refer to the Appendix for Host Interface quick set commands.

-  RS232 interface works with host devices running Windows, Linux, or Mac OS. USB COM interface works with host devices running Windows or Linux. To change the smart cradle's interface setting to USB COM, please first install the USB virtual COM driver on your host device. The driver may be downloaded from www.cino.com.tw.

Unpair Scanner from Smart Cradle

To unpair a scanner from its smart cradle: (a) scan the Uninstall barcode with the scanner, or (b) press and hold the smart cradle's reset button for 5 seconds.



Uninstall

To release specific pairings under PICO Mode, scan the Uninstall barcode with the relevant scanners.

Creating a Barcode for PICO Mode

Under PICO mode, multiple imagers (up to 7) can be paired with a smart dongle simultaneously. To establish pairings under this mode, you must create a pairing barcode for this purpose with a barcode generator.

- 1 Pair your dongle with an imager using the Quick Pair barcode.
- 2 Thereafter, scan the “System Information” command barcode. The MAC addresses of the dongle will be displayed on your host device.



- 3 Use your barcode generator to create the pairing barcode for PICO mode. The barcode’s symbology should be Code 128, and its format ought to be as follows:
<Fnc 3>Mxxxxxx
- 4 M is the prefix. xxxxxx represents the last 6 characters of the smart dongle’s MAC address.
For example, if the MAC address of the dongle is “00 25 14 11 11 11”, the pairing barcode will be “M111111”.

Clone Function

For the user's convenience, the clone function will help you to clone the host interface related parameters (please refer to following table for details) from one of the paired scanners to the rest of paired scanners under PICO mode. You can use one of the paired scanners to set the host interface related parameters first and then scan "Save Configuration" command. After that, please take the other paired scanners to scan "Clone" command one by one to clone the host interface related parameters.



Please ensure to keep those paired scanners in connected status when you use the **Clone** function. Because the host interface related parameters can't be cloned to the paired scanner in disconnected status.



Save Configuration



Clone

The below host interface related parameters will be impacted by clone function:

Data Transmission Parameter	Serial Interface Control
Field Delimiter	Handshaking Protocol
Data Transmission Format	Intermessage Delay
Host Interface Control	Interfunction Delay
Host interface Selection	Intercharacter Delay
Keyboard Interface Control	Baud Rate
Keyboard Layout	Data Frame
Intermessage Delay	Time Out Control
Interfunction Delay	Wand Emulation Control
Intercharacter Delay	Output Polarity
Caps Lock Control	Initial Signal State
Caps Lock Release Control	Margin Time
Function Key Emulation	Module Time
Key Pad Emulation	Narrow/Wide Ratio
Upper/Lower Case	Code39 Emulation

Using Scanner in HID Mode

- 1 Ensure the battery is fully charged. Power on the scanner within radio coverage and ensure the status indicator of scanner gives **alternative red and green blinks** (in “Uninstall” state). If your scanner is not in the Uninstall state, please scan the “Uninstall” command first.



Uninstall

If your remote host is equipped with latest Bluetooth drivers, or it's an iOS or Android device, it is recommended to use “**HID Mode**”..



HID Mode

Once you have scanned the “**HID Mode**” barcode, the scanner's link indicators will blink blue 3 times every 2 seconds during the search process. You will have to execute a Bluetooth Discovery procedure to find nearby Bluetooth device, then select “PF(L/A)xxxBT-xxxx” (the xxxx are the last 4 digits of its MAC address).

- 2 The scanner will emit 4 beeps in ascending tone to indicate the connection is established. The scanner's link indicators will also **flash blue every 2.5 seconds** to indicate a radio-connected state.
- 3 If the scanner is not paired with your host device within 1 minute after scanning the above command, it will enter radio-off state automatically. You can wake the scanner by pressing its trigger; this will also cause the scanner to re-attempt pairing.

The installation procedure may vary depending on different remote host devices, operating systems and the Bluetooth drivers. Please consult your professional IT consultant to obtain necessary support. For more detailed information, please visit CINO website.

Using Scanner in SPP Mode

Establish SPP Master Connection

- 1 Look for the host device's MAC address under its "Hardware" or "Bluetooth" settings. You will need this MAC address later on.
- 2 Ensure that a virtual COM port is available on your host device for scanner connection. If not, perform the steps required on your host device to add one. For example, go to "Local Services" under "Bluetooth Advanced Settings" and click on "Add Serial Services" to add a virtual COM port.
- 3 Power on the scanner within radio coverage, and make sure its status indicator gives **alternating red and green blinks** (in "**Uninstall**" state). If not, scan the "Uninstall" barcode to release its current pairing.



- 4 Scan the "**SPP Master Simple Mode**" barcode. The scanner's status indicator will turn steady red immediately.



- 5 Scan the 12 option codes (see Appendix) that correspond to your host device's MAC address, then scan the "FIN" barcode. The scanner will emit a series of clicking sounds and its link indicators will flash blue rapidly.
- 6 Launch your terminal application to connect it with the scanner. The scanner will emit 4 beeps in ascending tone to indicate radio connection, and its link indicator will **flash blue every 2.5 seconds**.
- 7 If the scanner fails to pair with host device within 30 seconds, its link indicator will give 3 blue blinks every 2 seconds. Thereafter, the scanner will continue to search for your host device for another 30 seconds before going into "Radio-Off" state. In the interim, you may scan the "Uninstall" command to set your scanner to the "Uninstall" state. If the scanner has entered radio-off state already, you can wake the scanner by pressing its trigger; this will also cause the scanner to re-attempt pairing.



The above procedures are based on popular Windows operation environment. But the installation procedure may vary depending on different remote host devices, operating systems and the Bluetooth drivers. Please consult your professional IT consultant to obtain necessary support if any problem is arise during the installation processes. For more detailed information, please visit CINO website.

Creating a Barcode for SPP Master Mode

You can create an SPP master mode barcode to rapidly pair a scanner with your Bluetooth-enabled host device.

- 1 Look for the host device's MAC address under its settings.
- 2 Use the MAC address and a barcode generator to create a Quick Pair barcode for your host device

The barcode's symbology should be Code 128, and its format ought to be as follows:

<Fnc 3>Sxxxxxxxxxxx

S is the prefix

xxxxxxxxxxx represents the 12 characters of the MAC address

For example, if the host device's MAC address is "22 22 22 11 11 11", the barcode will be: S22222211111.

Establish SPP Slave Connection

- 1 Ensure that a virtual COM port is available on your host device for scanner connection. If not, perform the steps required on your host device to add one. For example, go to “Local Services” under “**Bluetooth Advanced Settings**” and click on “**Add Serial Services**” to add a virtual COM port.
- 2 Power on the scanner within radio coverage, and make sure its status indicator gives off **alternating red and green blinks** (in “**Uninstall**” state). If not, scan the “Uninstall” barcode to release its current pairing.

**Uninstall**

- 3 Scan the “SPP Slave Simple Mode” barcode. The scanner’s status indicator will flash blue 3 times every 2 seconds while it waits for the pairing process to be launched.

**SPP Slave Simple Mode**

- 4 Execute the Bluetooth Discovery procedure to find all available Bluetooth device list in your remote host. You will see „F(L/A)xxxBT-xxx” (the xxx are the last 4 digits of its MAC address) is shown in the list if the scanner is successfully discovered. Perform the steps required on your host device to activate the pairing (e.g. tapping or double clicking on the model number, etc.). During the pairing process, the scanner will emit a series of clicking sounds and its link indicators will flash blue rapidly.
- 5 Launch your terminal application to build the connection with the scanner. The scanner will emit 4 beeps in ascending tone to indicate the radio is connected, and its link indicator will **flash blue every 2.5 seconds**.
- 6 If the scanner is not paired with the host device within 1 minute after scanning the above command, it will enter radio-off state automatically. You can wake up the scanner by pressing its trigger, this will also cause the scanner to re-attempt pairing.

Auto Reconnection On/Off under SPP Slave Mode

Cino has implemented a new auto reconnection function for SPP slave mode on all Bluetooth scanners. Scanners switch to SPP master mode automatically after successfully connecting to a device through SPP slave mode. This default function automates the Bluetooth reconnection process following a connection loss.

However, certain devices or applications don't support SPP master mode. User need to manually disable the Auto Reconnection function before connecting Cino Bluetooth scanners to such devices / applications via SPP slave mode.

Scan **Auto Reconnection Off** before connecting the scanner. To revert back to default auto reconnection function afterwards, scan the **Auto Reconnection On** barcode before pairing.



SPP Slave Auto Reconnection On ◆



SPP Slave Auto Reconnection Off

Pairing Bluetooth Imager with Dongle

- 1 Turn on your FuzzyScan Bluetooth imager. Make sure it is in an unpaired state: its status indicator should emit alternating red-green flashes. Otherwise, scan the “Uninstall” command barcode to release any prior pairing.
- 2 Initiate the dongle-imager pairing process by scanning the Quick Pair” barcode label of the dongle. Your imager will then produce clicking sounds, and its link indicator will flash blue rapidly. During this process, your dongle will continue to emit red and green lights.
- 3 Upon successful pairing, the scanner will beep 4 times in ascending tone, and its link indicator will flash blue every 2.5 seconds. The power/pairing indicator of the dongle will be a steady blue.



The Quick Pair barcode on your dongle is designed for “Pair Mode”, i.e. the dongle can only pair with one imager at a time. The dongle's default host interface setting is USB HID. To change this setting to USB COM, please first install the USB2COM driver on your host device.

Unpairing Bluetooth Imager from Dongle

To unpair the imager from a dongle, scan the “Uninstall” barcode with such imager. If unpairing is successful, the imager will beep 4 times in descending tone. Both the dongle and the imager will also emit red-green flashes to reflect their unpaired state.



Uninstall

Creating a Barcode for PAIR Mode

Under PAIR mode, only one imager can be paired with the smart dongle. The original Quick Pair barcode on the smart dongle is for PAIR mode. To create a back up pairing barcode under this mode, please follow the instructions below.

- ① Pair your dongle with an imager using the Quick Pair barcode.
- ② Thereafter, scan the “System Information” command barcode. The dongle’s MAC addresses will be displayed on your host device.



- ③ Use your barcode generator to create a pairing barcode for PAIR mode. The barcode’s symbology should be Code 128, and its format ought to be as follows:
<Fnc 3>Pxxxxxx
- ④ P is the prefix. xxxxxx represents the last 6 characters of the smart dongle’s MAC address
For example, if the dongle’s MAC address is “00 25 14 11 11 11”, the pairing barcode will be: P111111

Locked Pair Mode

When your scanner is paired with Smart dongle under PAIR mode, they become “unlocked” by default. You do not need to uninstall an unlocked PAIR before pairing another scanner with the dongle. You can also create a “locked” PAIR mode by scanning the “**Locked Pair Mode**” barcode before pairing. The dongle can be paired with any other scanner only if the current pairing is uninstalled.

To revert back to default “unlocked” mode afterwards, scan the **Unlocked Pair Mode** barcode before pairing.



Locked Pair Mode



Unlocked Pair Mode◆

Override the locked scanner

- 1 As mentioned, when the scanner and smart dongle are paired under PAIR mode, they become “locked” by default and can no longer be paired with other scanners unless the pair is uninstalled in advance.
- 2 If you want to override the pairing without uninstalling it first, you can scan “Override the locked scanner” before pairing. This will override the current pairing and pair new scanner with the smart dongle..



Override the locked scanner

Creating a Barcode for PICO Mode

Under PICO mode, multiple imagers (up to 7) can be paired with a smart dongle simultaneously. To establish pairings under this mode, you must create a pairing barcode for this purpose with a barcode generator.

- 1 Pair your dongle with an imager using the Quick Pair barcode.
- 2 Thereafter, scan the “System Information” command barcode. The dongle’s MAC addresses will be displayed on your host device.



SYSTEM INFORMATION

- 3 Use your barcode generator to create the pairing barcode for PICO mode. The barcode’s symbology should be Code 128, and its format ought to be as follows:
<Fnc 3>Mxxxxxx
- 4 M is the prefix. xxxxxx represents the last 6 characters of the MAC address of the smart dongle. For example, if the MAC address is “00 25 14 11 11 11”, the pairing barcode will be “M111111”.



To unpair a scanner under PICO mode, please scan the “Uninstall” barcode.

Enter Bluetooth Discoverable Mode (only available for pocket scanners)

If you use pocket scanner, you can have the scanner entered into Bluetooth discoverable mode for pairing with any remote host easily. When you press and hold the **FN1** for more than 3 seconds, the scanner will enter into preset Bluetooth discoverable mode. You have to carry out the Bluetooth discovery procedure to find the scanner for pairing. The preset Bluetooth profile for discoverable mode is “HID Mode”.

Out-of-range Scanning

When the radio connection is established between scanner and remote host device, the scanner will transmit each scanned data right after scanning the barcode. However, the default of the scanner is unable to scan any barcode data when it loses the radio connection with the remote host device. If you enable the out-of-range scanning function, the scanner is able to continue scanning barcode data while it is out of radio coverage. All scanned data will be temporarily stored into the memory buffer until radio link resumed.



Enable Out-of-range Scanning



Disable Out-of-range Scanning ◆

In case of the scanner is out of radio coverage, you will hear 4 beeps in descending tone to indicate the radio connection lost. The scanner’s link indicators will **blink blue 3 times per 2 seconds**. Once the scanner is back to radio coverage, you will hear 4 beeps in ascending tone to indicate the radio connection rebuilt and the scanner’s link indicators **blink blue once per 2.5 seconds**. At the same time, all the stored scanned data will be transmitted automatically right after the radio link is resumed.

Power Off the Scanner

By default, the scanner goes off if the scanner is not used during the user-defined time-out duration. You also can power off the scanner by scanning the “Power Off” command. If you want to activate the scanner, please press the trigger key.



Power Off

Batch Scanning Mode (Inventory Mode)

Thanks to the specially designed Batch Scanning function, the scanner is capable of storing the barcode data. It is an ideal cost-saving solution for inventory applications.

Once you scan the “Enter Batch Scanning” command to activate this function, all scanned barcode data will be stored into the memory storage, and the status indicator of scanner will give **green blink** at regular interval during batch scanning. You can scan and store the barcode data till the memory storage is full. If the storage is full, you will hear 2 long beeps and the status indicator will give 2 red blinks to indicate **out of storage**.

If you use pocket scanner, you can also press and hold the **Function Key 2** for more than 3 seconds to enter Batch Scanning, by which 3 beeps will be heard and the status indicator of the scanner will **blink green** at regular interval during batch scanning.

To exit the batch scanning, please scan the “Exit Batch Scanning” command. If you use pocket scanner, you can also exit the batch scanning by pressing and holding **Function Key 2** for more than 3 seconds.



Enter Batch Scanning



Exit Batch Scanning

Adding a Quantity Value to Barcode Data

The scanner supports quantity feature when it enters batch scanning. When you use quantity feature, the quantity information and scanned barcode data will be stored into the memory storage together. You can enter the quantity information from 1 to 9999 by scanning the following quantity commands right after you scanned the barcode data.



Quantity 0



Quantity 3



Quantity 5



Quantity 8



Quantity 1



Quantity 4



Quantity 6



Quantity 9



Quantity 2



Quantity 7



Quantity 9

There are three ways to output the stored barcode data and quantity information. The preset output format is to transmit stored data as many times as the quantity indicated. But you still can set the scanner to output stored barcode data together with quantity information in two fields, and a preset delimiter” , ” will be output in between. To fulfill different application requirements, both the delimiter and output sequency can be changed as well.



As many times as the quantity indicates ◆



<Quantity><Field Delimiter><Scanned Data>



<Scanned Data><Field Delimiter><Quantity>

How to Transmit Stored Data

The scanner is preset to transmit all the stored data by scanning the “Transmit Stored Data” command. If you use pocket scanner, you can also transmit the stored data by pressing and holding **Left Key** for more than 3 seconds. During the transmission, the scanner will emit continuous short clicks and the link indicator will **blink blue**. Then the scanner will emit two short beeps after data transmission is completed.



Transmit Stored Data

But you are able to transmit the stored data by placing the scanner onto the cradle as well.



Scan Barcode Command ◆



Place Scanner onto the Cradle



Scan command or Place Scanner onto the Cradle

How to Delete Scanned Data

The scanner is preset to keep all the stored data until you scan the “Clear All Stored Data” command. But you are still able to change the setting to “Auto Delete Stored Data after Transmission” as well.



Clear All Stored Data



Auto Delete Stored Data
after Transmission



Keep Stored Data after
Transmission ◆

How to Delete the Last Scanned Data

If you scanned a wrong barcode, the last scanned data can be deleted by scanning the “Delete Last Scanned Data” command. If you use pocket scanner, you can also delete the last scanned data by short pressing the **FN2**.



Delete Last Scanned Data

Validation Scanning Mode

Validation Scanning function is provided to check whether the scanning barcode matches the registered master data or not. The scanner is capable of storing up to **2K bytes** master data.

You can have your scanner entered or exited the Validation Scanning by scanning the following commands. You will hear 3 short beeps when entering in Validation Scanning. The status indicator of the scanner will blink green once per 2.5 seconds to indicate the scanner is under Validation Scanning. To terminate the validation scanning, please scan the “Exit Validation Scanning” command, the scanner will emit 3 short beeps.



Enter Validation Scanning



Exit Validation Scanning

The Batch Scanning (Inventory Mode) is set as the default Function Mode. Batch Scanning and Validation Scanning can't be used at the same time. If you want to use the Function Key of pocket scanner to carry out Validation Scanning, you have to change the “FN2 Function Mode” default setting.

If you use pocket scanner, you can press and hold the **FN 2** for more than 3 seconds to enter Validation Scanning. The scanner will emit 3 short beeps and the status indicator of the scanner will blink green once per 2.5 seconds to indicate the scanner is under Validation Scanning. To exit Validation Scanning, press and hold the **FN 2** for more than 3 seconds, the scanner will emit 3 short beeps.

Register Master Data

Master Data Registration allows you to register your master data for validating the slave data. You can have the scanner entered or exited “Master Data Registration” by scanning following quick set commands.



Register Master Data



Finish Registering Master Data

If you use pocket scanner, you can also have your scanner entered Master Data Registration by short pressing the FN2. The scanner will emit 2 short beeps and the status indicator will become steady green. Once you complete master data registration, you can have the scanner exited “Master Data Registration” by short pressing FN2

After entering Master Data Registration, you can scan and register single or multiple master data by pressing the Trigger Key. If the master data is registered successfully, the scanner will emit 1 good read short beep.

The default Master Data Registration Setting is preset to” Single Master Data”, though you can scan multiple master data continuously, only the last master data will be valid, and the master data registered previous to the last master data will be cleared. The scanner is capable of storing up to 2K bytes master data.

All scanned master data will be stored into the memory storage. You can scan and store the barcode data till the memory storage is full. If the storage is full, the scanner will emit 2 long beeps and the status indicator will blink red twice to indicate out of storage. Please note that the registered master data will be eliminated once you power off the scanner

You can clear the master data by scanning following command.



Clear Master Data

After registering master data, you can check registered master data by scanning following command.



Check Master Data



If the scanner is under “Master Data Registration” and put onto cradle for charging, the status indicator will show battery status indication. Once the scanner leaves the cradle, the scanner will resume to previous status, and the status indicator will present correspondent status indication.

Toggle between Barcode Scanning and On-screen Keyboard Input

You can toggle between use barcode scanning and on-screen keyboard input of the mobile device. To activate the on-screen keyboard input function; you can turn off the radio by scanning “**Switch On-screen Keyboard**” command. If you use pocket scanner, you can turn off the radio to activate the on-screen keyboard input by short pressing the **FN1** Once you finished the keyboard input, pressing the trigger once to turn on the radio, the on-screen keyboard input function will be inactivated.

The scanner is preset to use “General Approach” by controlling the radio to toggle between barcode scanning and on-screen keyboard input of most popular mobile devices. To work with iOS devices, please scan “iOS Ap n-screen keyboard input. If you use pocket scanner, the **FN1** can be set to “iOS Approach” to quickly toggle iOS on-screen keyboard input, and you can also toggle the iOS on-screen keyboard input by short pressing the **FN1**.



General Approach ◆



iOS Approach



Switch On-screen Keyboard

Presentation Scanning (Pistol type scanner only)

The Presentation Scanning is designed for hand-free applications for user’s convenience. If the “Presentation Scanning Auto-sense” function is enabled, the scanner is capable of automatically switching to presentation mode as soon as you place it onto the SmartStand or cradle.



Enable Auto-sense



Disable Auto-sense ◆

Check Battery Status

You can check battery status of the scanner by short pressing the Left Key or scanning “Check Battery Status” command. Please refer to the “Battery Status Indication” shown on page 1 for details.



Check Battery Status

Battery Status Indication

The following corresponding flashes of the LED indicators present the current battery status of the scanner.

LED Indication	Battery Status
3 green and blue flashes	More than 75%
3 green flashes	More than 50%
3 orange flashes	More than 25%
3 red flashes	Less than 25%

Paging Function

The Paging function is helpful for you to locate the paired smart cradle or scanner. If you would like to page the paired smart cradle, you can scan “Paging” command. If you would like to page the paired scanner, you can press the paging/reset button of the smart cradle **no longer** than 3 seconds.

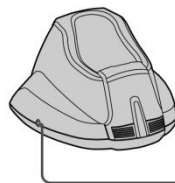

Paging/Reset Button



Paging

CONFIGURING YOUR SCANNER

Configuration Barcode Menu

The FuzzyScan barcode commands are specially designed **Proprietary** bar code labels which allow you to set the FuzzyScan internal programming parameters. There are **System Command**, **Family Code** and **Option Code** for programming purpose.

Each programmable family and bar code command label is listed on the same page with major system commands. The detailed explanations and special programming flowchart are printed on facing or following pages. You can read the explanation and set the FuzzyScan concurrently.

A supplemental bar code command menu incorporates the bar code command labels of System Command and Option Code. As you set the FuzzyScan, open the bar code command menu to find the option code page. You may scan the desired family code and option code to set FuzzyScan. If you want to change the programming family for multiple settings, you need only turn over the programming page to find next desired programming family.

System Command

The System Command is the highest level bar code command which directs FuzzyScan to perform immediate operations, such as entering programming mode (**PROGRAM**), exiting programming mode (**EXIT**), listing system information (**SYSLIST**), recovering to factory preset configurations (**M_DEFAULT**), and so on. Please note that all system commands will take a few seconds to complete the operations. User must wait for the completion beeps before scanning another bar code.

Family Code

The Family Code is scanned to select the user desired programming family. FuzzyScan has already provided more than one hundred programming families to meet any specific requirements.

Option Code

The Option Codes is a set of bar code commands represented by “**0–9**”, “**A–F**” and finishing selection (**FIN**). For most setting, you must select at least one option code following the family code selection to set the desired parameter for the selected programming family.

Programming Procedures

As you scan the bar code command to select the desired parameters, information about the final selected parameters represented by the bar code commands are stored in the FuzzyScan's internal Flash Memory ASIC or non-volatile memory. If you turn off the unit, the Flash Memory ASIC or non-volatile memory retains all programming options. You need not re-program the FuzzyScan if you want to keep the existing configurations in the next power on.

The programming procedures of FuzzyScan are designed as simple as possible for ease of setting. Most programming families take the **Single Scan Selection** programming procedure. But several programming families have more complex and flexible programmable options, and you must take **Multiple Scans Selection, Cycling Scan Selection or Dual Level Selection** to complete their programming procedures. Each kind of programming procedure is listed in the following pages for your reference. Please give careful attention to become familiar with each programming procedure.

If the programming family must take multiple scans selection, cycling scan selection, or dual level selection procedures, the family of the programming menu will be marked with the matched representing symbol of **Programming Category** (P.C.) in bold font listed in the following table. You can easily find the bold mark in the programming menu, and refer to their flowcharts for details. Before setting the FuzzyScan, please also refer to the "Beeping Indications" listed in Appendix to understand the details of programming beeping indications. It will be very helpful for you to know the existing status while you are programming the FuzzyScan.

Conventions of Programming Menu

Conventions	Descriptions
◆	Factory Default Value
P.C.	Programming Category SS : Single scan selection MS : Multiple scans selection CS : Cycling scan selection DS : Dual level scan selection
()	Necessary Option Code
[]	Selectable Option Code

Program & End

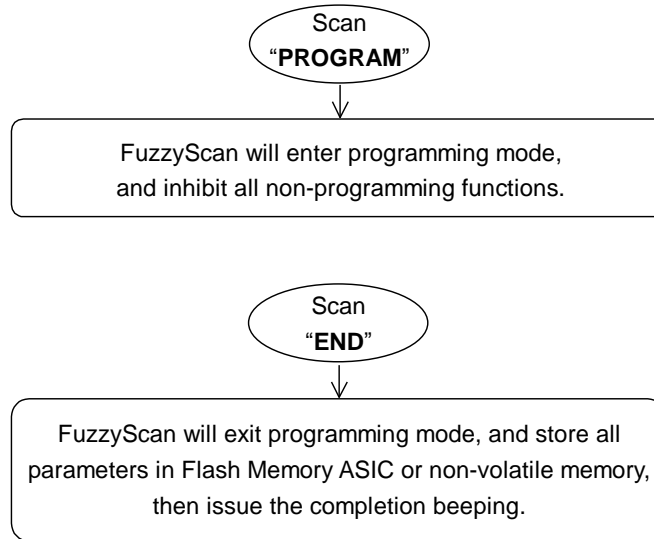

System List, Group & Master Default

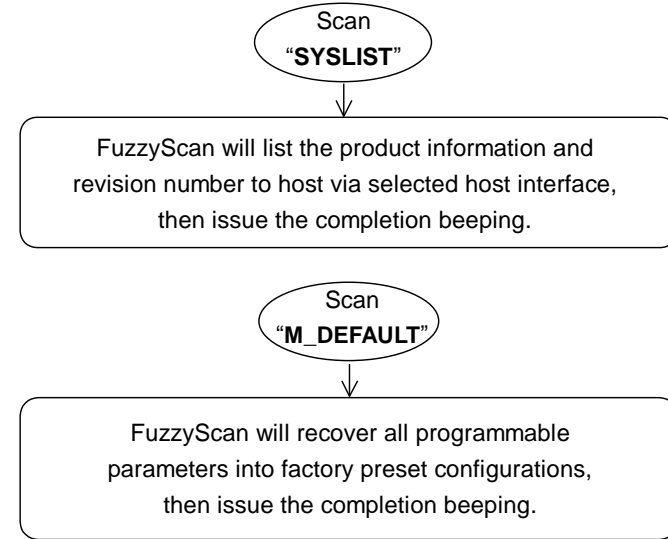

Please note that the FuzzyScan will take 3-4 seconds to store parameters in internal Flash Memory ASIC or non-volatile memory after you scan the “END”. Please **don’t** turn off the power before the completion beeping. It may destroy all configured parameters.

Single scan selection

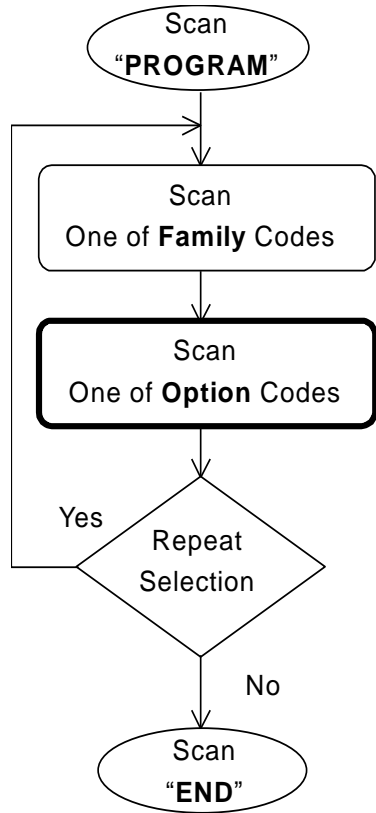

Enter programming mode.

Select one of desired programming families.

Select one option code of desired parameter.

Want to select another programming family?

Exit programming mode.

Multiple scans selection

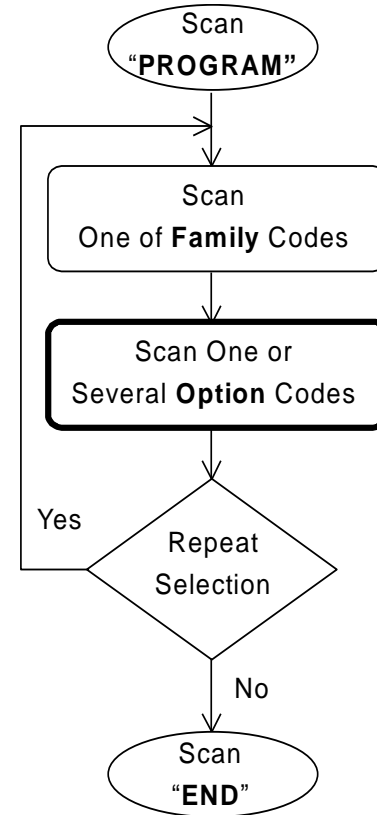

Enter programming mode.

Select one of desired programming families.

1. Select one or several option codes to select desired parameters.
2. If it's necessary, scan "FIN" to terminate option code selection.

Want to select another programming family?

Exit programming mode.

Cycling scan selection

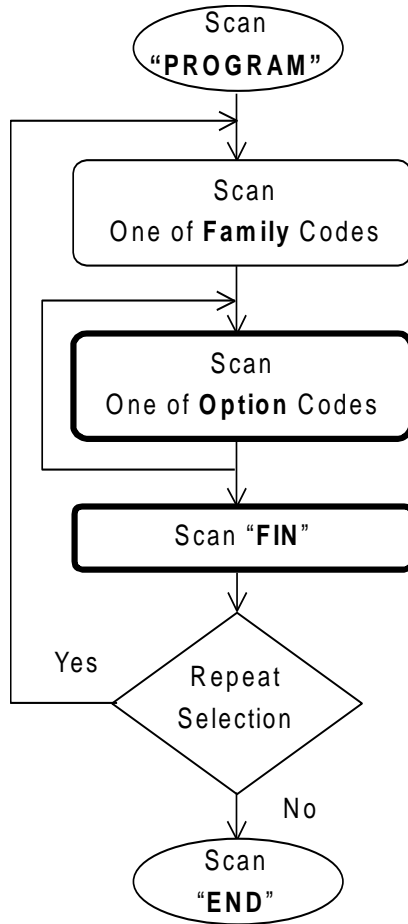

Enter programming mode.

Select one of desired programming families.

Cycling select one or several option codes of desired parameters as "Single" or "Multiple" scans selection.

Finish cycling selection.
(If necessary)

Want to select another programming family?

Exit programming mode.

Dual level selection

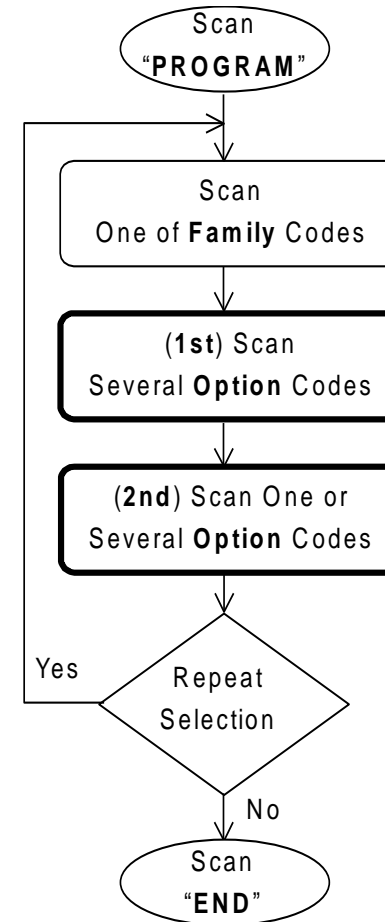

Enter programming mode.

Select one of desired programming families.

Select several option codes of desired parameters.

1. Select one or several option codes of desired parameters.
2. If it's necessary, scan "FIN" to terminate option code selection.

Want to select another programming family?

Exit programming mode.



PROGRAM

Host Interface Selection



F_DEFAULT

Family Code Selection	P.C	Parameter Selection	Option Code
Host Interface Selection 	MS	IBM PS/2, 25-30 series keyboard wedge interface	02
	MS	Standard/TTL RS-232 peer-to-peer serial	06
	MS	Wand emulation	08
	MS	USB Com Port Emulation	09
	MS	PS/2 (DOS/V) direct link (keyboard replacement)	10
	MS	PS/2 (DOS/V) keyboard wedge turbo mode	13
	MS	PS/2 (DOS/V) keyboard wedge standard mode	14
	MS	Laser emulation	17
	MS	USB HID standard mode ◆	18
	MS	USB HID turbo mode	19
	MS	USB HID Legacy	20
	MS	USB EFT Terminal Mode	21

▪ **A series** doesn't support Wand emulation, Laser emulation, and USB HID Legacy Mode.



PROGRAM

Symbology Reading Control User Defined Symbol ID



F_DEFAULT

Family Code Selection	P.C	Parameter Selection	Option Code	2nd Option Code
Symbol ID : 1 character 	DS	Code 128 (default= B)	00	(1 character)
		GS1-128 (default= C)	01	(1 character)
		UPC-A (default= A)	02	(1 character)
		EAN-13 (default= F)	03	(1 character)
		Codabar/NW-7 (default= D)	04	(1 character)
		Code 39/Code 32 (default= G)	05	(1 character)
		Code 93 (default= H)	06	(1 character)
		Standard/Industrial 2 of 5 (default= I)	07	(1 character)
		Interleaved 2 of 5 (default= J)	08	(1 character)
		Matrix 2 of 5 (default= K)	09	(1 character)
		China Postal Code (default= L)	10	(1 character)
		German Postal Code (default= M)	11	(1 character)
		IATA (default= O)	12	(1 character)
		Code 11 (default= P)	13	(1 character)
		MSI/Plessey (default= R)	14	(1 character)
		UK/Plessey (default= S)	15	(1 character)
		Telepen (default= T)	16	(1 character)
		GS1 DataBar (default= X)	17	(1 character)
		UPC-E (default= E)	18	(1 character)
		EAN-8 (default= N)	19	(1 character)
		Trioptic Code 39 (default= W)	20	(1 character)
		UCC Coupon Extended Code (default= Z)	21	(1 character)
		PDF417/Micro PDF417 (default= V)	22	(1 character)
		Codablock F (default= Y)	23	(1 character)
		Code 16K (default= Q)	24	(1 character)
		Code 49 (default= U)	25	(1 character)
		Korea Post Code (default= a)	26	(1 character)
		QR & Micro QR Code (default= b)	28	(1 character)
		Data Matrix (default= c)	29	(1 character)
		Maxi Code (default= d)	30	(1 character)



PROGRAM

Symbology Reading Control User Defined Symbol ID (continued)



F_DEFAULT

Family Code Selection	P.C	Parameter Selection	Option Code	2nd Option Code
Symbol ID : 1 character 	DS	Aztec Code (default=e)	31	(1 character)
		Chinese Sensible (default=f)	32	(1 character)
		Australian Post (default=g)	33	(1 character)
		British Post (default=h)	34	(1 character)
		Intelligent Mail (USPS 4CB/One Code) (default=j)	36	(1 character)
		Japan Post (default=k)	37	(1 character)
		Netherlands KIX Post (default=l)	38	(1 character)
		US Planet (default=m)	39	(1 character)
		US Postnet (default=o)	41	(1 character)



PROGRAM

Symbology Reading Control Symbology ID Transmission



F_DEFAULT

Family Code Selection	P.C	Parameter Selection	Option Code
 Symbology ID Transmission	SS	Disable symbology ID transmission ◆	0
	SS	Enable prefix CINO symbology ID transmission	1
	SS	Enable suffix CINO symbology ID transmission	2
	SS	Enable both prefix and suffix CINO symbology ID transmission	3
	SS	Enable prefix AIM symbology ID transmission	4
	SS	Enable suffix AIM symbology ID transmission	5
	SS	Enable both prefix and suffix AIM symbology ID transmission	6



PROGRAM

Symbology Reading Control

ECI ID Output

(A Series, PA Series)



F_DEFAULT

Family Code Selection	P.C	Parameter Selection	Option Code
ECI ID Output 	SS SS	Disable ECI ID Output ◆ Enable ECI ID Output	0 1

* The ECI (Extended Channel Interpretation) is embedded information in a bar code that tells the used references for encoding the data in the symbol. By enabling ECI ID output, the associated ECI ID value will be outputted with the data at the same time.



PROGRAM

Symbology Reading Control Readable Bar Code Setting



F_DEFAULT

Family Code Selection	P.C	Parameter Selection	Option Code
Readable Symbology Setting  <div style="border: 1px solid black; padding: 5px; width: fit-content;"> Remember to scan "FIN" to terminate this selection. But if you select the "Auto", FuzzyScan will terminate this selection automatically. </div>	SS	Auto ◆	00
	CS	Popular 1D	C0
	CS	Code 128 *	01
	CS	GS1-128 *	31
	CS	UPC-A *	02
	CS	UPC-E *	03
	CS	EAN-13 *	04
	CS	EAN-8 *	05
	CS	Codabar/NW-7 *	06
	CS	Code 39 *	07
	CS	Trioptic Code 39	47
	CS	Standard/Industrial 2 of 5	08
	CS	Matrix 2 of 5	38
	CS	Interleaved 2 of 5 *	48
	CS	China Postal Code	58
	CS	Germany Postal Code	68
	CS	Code 93 *	09
	CS	Code 11	10
	CS	MSI/Plessey	11
	CS	UK/Plessey	12
	CS	Telepen	13
	CS	GS1 DataBar (RSS-14) *	14
	CS	IATA	15
	CS	PDF417 * /Micro PDF417	17
	CS	Codablock F	18
	CS	Code 16K	19
	CS	Code 49	20
CS	Korea Post Code	21	
CS	QR Code * / Micro QR Code *	A0	
CS	Data Matrix *	A1	
CS	MaxiCode	A2	
CS	Aztec Code *	A3	
CS	Chinese Sensible (Han Xin) Code	A4	



PROGRAM

Symbology Reading Control

Readable Bar Code Setting (continued)



F_DEFAULT

Family Code Selection	P.C	Parameter Selection	Option Code
Readable Symbology Setting 	CS	Australian Post	B0
	CS	British Post	B1
	CS	Intelligent Mail barcode	B3
	CS	Japanese Post	B4
	CS	KIX Post	B5
	CS	Planet Code	B6
	CS	Postnet	B8

- If your application is known, you may select those known symbologies only to increase the reading speed and decrease the possibility of reading error. Furthermore, to add the **"Symbology ID"** into the transmitted data is also helpful to identify the specific symbology.
- Above symbologies marketed with * are enabled as default. When you select "Auto", the scanner only reads those symbologies marked with *.
- "Popular 1D" includes "Code 128", "GSA-128", "UPC-A", "UPC-E", "EAN-13", "EAN-8", "Codabar/NW-7", "Code 39", "Interleaved 2 of 5", "Code 93", "GS1 DataBar (RSS-14)".
- When you set the minimum and maximum length of each symbology, please note the data length of scanned bar code doesn't include start/stop characters.



PROGRAM

Symbology Reading Control Code 39/Code 32 Setting



F_DEFAULT

Family Code Selection	P.C	Parameter Selection	Option Code
Code 39 Family Setting 	SS	Disable Code 39	0
	SS	Enable Code 39 ◆	1
	SS	Select Standard Code 39 as primary format ◆	2
	SS	Select Full ASCII Code 39 as primary format	3
	SS	Select Code 32 (PARAF, Italian Pharmaceutical) as primary format	4
	SS	Disable start/stop symbol transmission ◆	5
	SS	Enable start/stop symbol transmission	6
	SS	Disable Code 32 leading A transmission ◆	7
	SS	Enable Code 32 leading A transmission	8
	SS	Disable MOD 43 check digit verification ◆	9
	SS	Enable MOD 43 check digit verification	A
	SS	Disable check digit transmission ◆	B
	SS	Enable check digit transmission	C
	SS	Disable Code 39 buffering ◆	D
	SS	Enable Code 39 buffering	E
Trioptic Code 39 Setting 	SS	Disable Trioptic Code 39 ◆	0
	SS	Enable Trioptic Code 39	1
Code 39 Min. Length 	SS	Default (01) ◆	FIN (2 digits)
	MS	01-Maximum Scan 2 digits from the option code chart in Appendix, then FuzzyScan will terminate this selection automatically.	
Code 39 Max. Length 	SS	Default (98) ◆	FIN (2 digits)
	MS	98-Minimum Scan 2 digits from the option code chart in Appendix, then FuzzyScan will terminate this selection automatically.	

■ Trioptic Code 39 and Code 39 Full ASCII cannot be enabled simultaneously.



PROGRAM

Symbology Reading Control Code 39/Code 32 Setting (continued)



F_DEFAULT

Family Code Selection	P.C	Parameter Selection	Option Code
Code 39 Security Level 	SS SS SS SS	Level 0 Level 1 Level 2 ◆ Level 3	0 1 2 3

▪ **Code 39 Security Level**

The scanner offers four levels of decode security for Code39 bar codes:

Level 0: If you are experiencing misread of poorly-printed or serious out-of-spec. bar codes in level 1, please select level 0.

Level 1: If you are experiencing misread of poorly-printed or out-of-spec. bar codes in level 2, please select level 1.

Level 2: This is the default setting which allows the scanner to operate fastest, while providing sufficient security in decoding "in-spec" Code39 bar codes.

Level 3: If you failed to read poorly-printed or out-of-spec. bar codes in level 2, please select level 3. This is the most aggressive setting and may increase the misread.



PROGRAM

Symbology Reading Control Codabar/NW-7 Setting



F_DEFAULT

Family Code Selection	P.C	Parameter Selection	Option Code
Codabar Setting 	SS	Disable Codabar	0
	SS	Enable Codabar ◆	1
	SS	Select Codabar standard format ◆	2
	SS	Select Codabar ABC format	3
	SS	Select Codabar CLSI format	4
	SS	Select Codabar CX format	5
	SS	Disable start/stop symbol transmission ◆	6
	SS	Enable ABCD/ABCD start/stop symbol transmission	7
	SS	Enable abcd/abcd start/stop symbol transmission	8
	SS	Enable ABCD/TN*E start/stop symbol transmission	9
	SS	Enable abcd/tn*e start/stop symbol transmission	A
	SS	Disable check digit verification ◆	B
	SS	Enable check digit verification	C
	SS	Disable check digit transmission ◆	D
SS	Enable check digit transmission	E	
Codabar Check Digit Settings 	SS	Modulus 16 ◆	0
	SS	Modulus 10/weight 3	1
	SS	Modulus 11	2
	SS	Modulus 10/weight 2	3
	SS	7 check DR	4
	SS	Weight Modulus 11	5
	SS	Runes (Modulus 10/weight 2)	6
Codabar Min. Length 	SS	Default (04) ◆	FIN (2 digits)
	MS	01-Maximum Scan 2 digits from the option code chart in Appendix, then FuzzyScan will terminate this selection automatically.	



PROGRAM

Symbology Reading Control

Codabar/NW-7 Setting (continued)



F_DEFAULT

Family Code Selection	P.C	Parameter Selection	Option Code
Codabar Max. Length 	SS MS	Default (98) ◆ 98-Minimum Scan 2 digits from the option code chart in Appendix, then FuzzyScan will terminate this selection automatically.	FIN (2 digits)



PROGRAM

Symbology Reading Control UPC-A & UPC-E Setting



F_DEFAULT

Family Code Selection	P.C	Parameter Selection	Option Code
UPC Family Setting 	SS	Disable UPC-A	0
	SS	Enable UPC-A ◆	1
	SS	Disable UPC-E	2
	SS	Enable UPC-E ◆	3
	SS	Disable UPC-E expansion ◆	4
	SS	Enable UPC-E expansion	5
	SS	Disable UPC standardization ◆	6
	SS	Enable UPC standardization	7
	SS	Disable UPC numeric system	8
	SS	Enable UPC numeric system ◆	9
	SS	Disable UPC-A check digit transmission	A
	SS	Enable UPC-A check digit transmission ◆	B
	SS	Disable UPC-E check digit transmission	C
	SS	Enable UPC-E check digit transmission ◆	D
	SS	Disable UPC "leading 1" portion ◆	E
	SS	Enable UPC "leading 1" portion	F

- When enable UPC-E expansion, the UPC-E decoded data will be converted to UPC-A format and affected by related setting, such as UPC standardization, UPC numeric system, UPC-A check digit transmission.
- **UPC-E & EAN-8 Expansion** : Expand the 8-digit UPC-E and 8-digit ENA-8 to 12-digit UPC-A and 13-digit EAN-13.
- **UPC-A/E Standardization** : Expand the 12-digit UPC-A to 13-digit EAN-13 with 1 zero insertion.
- **UPC Lead 1 Numeric System** : Enable to read UPC leading with the 1 numeric system, you must enable this option.

WPC Selection (UPC/EAN/CAN)	Basic Length	Disable Check Digit	Disable Numeric System	With 2-digit Addendum	With 5-digit Addendum	Enable Standardization	Enable Expansion
UPC-A	12	- 1	- 1	+ 2	+ 5	+ 1	0
UPC-E	8	- 1	- 1	+ 2	+ 5	+ 1	+ 4
EAN-13	13	- 1	NC	+ 2	+ 5	NC	0
EAN-8	8	- 1	NC	+ 2	+ 5	NC	+ 5





PROGRAM

Symbology Reading Control

UPC-A & UPC-E Setting (continued)



F_DEFAULT

Family Code Selection	P.C	Parameter Selection		Option Code	
UPC Supplement Setting 	SS	Select UPC without supplement digits ◆		0	
	SS	Select UPC with only 2 supplement digits		1	
	SS	Select UPC with only 5 supplement digits		2	
	SS	Select UPC with 2/5 supplement digits		3	
	SS	Disable force supplement digits output ◆		4	
	SS	Enable force supplement digits output		5	
	SS	UPC Family Addenda Separator Off ◆		6	
	SS	UPC Family Addenda Separator On		7	
UPC/EAN Security Level 	SS	Level 0		0	
	SS	Level 1 ◆		1	
	SS	Level 2		2	
		Only available for UPC-A & EAN-13			
Supplement Scan Voting 	SS	None	Level 7	0	7
	SS	Level 1	Level 8	1	8
	SS	Level 2	Level 9	2	9
	SS	Level 3 ◆	Level 10	3	A
	SS	Level 4	Level 11	4	B
	SS	Level 5	Level 12	5	C
	SS	Level 6	Level 13	6	D

- **UPC/EAN Security Level**
 The scanner offers three levels of decode security for UPC/EAN bar codes:

 - Level 0: If you are experiencing misread of poorly-printed or out-of-spec. bar codes, especially in characters 1, 2, 7, and 8 in level 1, please select level 0. Selection of this security level may significantly impair the decoding ability of the scanner.
 - Level 1: This is the default setting which allows the scanner to operate fastest, while providing sufficient security in decoding “in-spec” UPC/EAN bar codes.
 - Level 2: If you failed to read poorly-printed or out-of-spec. bar codes in level 1, please select level 2. This is the most aggressive setting and may increase the misread.
- The **Supplement Scan Voting** is the number of times the same UPC/EAN with 2/5 supplement digits has to be decoded before it is transmitted. It is helpful when decoding a mix of UPC/EAN symbols with and without supplement digits. This function is effective when you select UPC/EAN with only 2 supplement digits, UPC/EAN with only 5 supplement digits or UPC/EAN with 2/5 supplement digits. The default value is Level 3. When you select higher level, it may impact the reading speed on poorly-printed, low contrast or damage barcode labels.



PROGRAM

Symbology Reading Control EAN Setting



F_DEFAULT

Family Code Selection	P.C	Parameter Selection		Option Code	
EAN Setting 	SS	Disable EAN-13		0	
	SS	Enable EAN-13 ◆		1	
	SS	Disable EAN-8		2	
	SS	Enable EAN-8 ◆		3	
	SS	Disable EAN-8 expansion ◆		4	
	SS	Enable EAN-8 expansion		5	
	SS	Disable EAN-13 check digit transmission		6	
	SS	Enable EAN-13 check digit transmission ◆		7	
	SS	Disable EAN-8 check digit transmission		8	
	SS	Enable EAN-8 check digit transmission ◆		9	
	SS	Disable ISBN/ISSN Conversion reading check ◆		A	
	SS	Enable ISBN/ISSN Conversion reading check		B	
EAN Supplement Setting 	SS	Select EAN without supplement digits ◆		0	
	SS	Select EAN with only 2 supplement digits		1	
	SS	Select EAN with only 5 supplement digits		2	
	SS	Select EAN with 2/5 supplement digits		3	
	SS	Disable force supplement digits output ◆		4	
	SS	Enable force supplement digits output		5	
	SS	EAN Addenda Separator Off ◆		6	
	SS	EAN Addenda Separator On		7	
Supplement Scan Voting 	SS	None	Level 7	0	7
	SS	Level 1	Level 8	1	8
	SS	Level 2	Level 9	2	9
	SS	Level 3 ◆	Level 10	3	A
	SS	Level 4	Level 11	4	B
	SS	Level 5	Level 12	5	C
	SS	Level 6	Level 13	6	D

▪ The **Supplement Scan Voting** is the number of times the same UPC/EAN with 2/5 supplement digits has to be decoded before it is transmitted. It is helpful when decoding a mix of UPC/EAN symbols with and without supplement digits. This function is effective when you select UPC/EAN with only 2 supplement digits, UPC/EAN with only 5 supplement digits or UPC/EAN with 2/5 supplement digits. The default value is Level 3. When you select higher level, it may impact the reading speed on poorly-printed, low contrast or damage barcode labels.



PROGRAM

Symbology Reading Control EAN Setting (continued)



F_DEFAULT

Family Code Selection	P.C	Parameter Selection	Option Code
UPC/EAN Security Level 	SS	Level 0	0
	SS	Level 1 ◆	1
	SS	Level 2	2
		Only available for UPC-A & EAN-13	
EAN Supplement Control 	SS	Disable all specific prefix supplement digital output ◆	0
	SS	Enable all specific prefix supplement digital output	1
	SS	Enable 491 Supplement Digit Output	2
	SS	Enable 978/979 Supplement Digit Output	3
	SS	Enable 977 Supplement Digit Output	4
	SS	Enable 378/379 Supplement Digit Output	5
	SS	Enable 414/419 Supplement Digit Output	6
	SS	Enable 434/439 Supplement Digit Output	7

- **UPC/EAN Security Level**
 The scanner offers three levels of decode security for UPC/EAN bar codes:
 Level 0: If you are experiencing misread of poorly-printed or out-of-spec. bar codes, especially in characters 1, 2, 7, and 8 in level 1, please select level 0. Selection of this security level may significantly impair the decoding ability of the scanner.
 Level 1: This is the default setting which allows the scanner to operate fastest, while providing sufficient security in decoding "in-spec" UPC/EAN bar codes.
 Level 2: If you failed to read poorly-printed or out-of-spec. bar codes in level 1, please select level 2. This is the most aggressive setting and may increase the misread.
- **EAN Supplement Control**
 If you select EAN with only 2, or 5 or 2/5 supplement digits and enable 491 prefix supplement digit output, the scanner will transmit EAN with 2, or 5 or 2/5 supplement digits bar codes starting with 491 prefix. The EAN without supplement digit **will not** be transmitted.
 If you select EAN with only 2, or 5 or 2/5 supplement digits and enable the other except 491 prefix supplement digit output, the scanner will transmit EAN with 2, or 5, or 2/5 supplement digits bar codes starting with specific prefix. The EAN without supplement digit **will** be transmitted.



PROGRAM

Symbology Reading Control UCC Coupon Extended Code Setting



F_DEFAULT

Family Code Selection	P.C	Parameter Selection	Option Code
UCC Coupon Extended Code 	SS SS	Disable UCC Coupon Extended Code ◆ Enable UCC Coupon Extended Code	0 1

▪ UCC Coupon Extended Code

When UCC coupon extended code function is enabled, scanner decodes UPC-A barcodes starting with digit “5”, EAN-13 barcodes starting with digit “99” and GS1-128 Coupon Codes. UPC-A, EAN-13 and EAN-128 must be enabled to scan all types of Coupon Codes.





PROGRAM

Symbology Reading Control IATA & Interleaved 2 of 5 Setting



F_DEFAULT

Family Code Selection	P.C	Parameter Selection	Option Code
IATA Setting 	SS	Disable IATA ◆	0
	SS	Enable IATA	1
	SS	Select 15-digit fixed length IATA checking ◆	2
	SS	Select variable length IATA	3
	SS	Disable check digit verification ◆	4
	SS	Enable check digit automatic verification	5
	SS	Enable S/N checking digit verification only	6
	SS	Enable CPN checking digit verification only	7
	SS	Enable CPN, Airline and S/N check digit verification	8
	SS	Disable check digit transmission ◆	9
	SS	Enable check digit transmission	A
	SS	Disable start/stop symbol transmission ◆	B
	SS	Enable start/stop symbol transmission	C
Interleaved 2 of 5 Setting 	SS	Disable Interleaved 2 of 5	0
	SS	Enable Interleaved 2 of 5 ◆	1
	SS	Select Interleaved 2 of 5 as primary format ◆	2
	SS	Select German Postal Code as primary format	3
	SS	No check character ◆	4
	SS	Validate USS check digit	5
	SS	Validate OPCC check digit	6
	SS	Disable check digit transmission ◆	7
	SS	Enable check digit transmission	8





PROGRAM

Symbology Reading Control Code 25 Family Setting



F_DEFAULT

Family Code Selection	P.C	Parameter Selection	Option Code
Code 25 Setting 	SS	Disable Standard/Industrial 2 of 5 ◆	0
	SS	Enable Standard/Industrial 2 of 5	1
	SS	Disable Matrix 2 of 5 ◆	2
	SS	Enable Matrix 2 of 5	3
	SS	Disable China Postal Code ◆	4
	SS	Enable China Postal Code	5
	SS	Disable check digit verification ◆	6
	SS	Enable check digit verification	7
	SS	Disable check digit transmission ◆	8
	SS	Enable check digit transmission	9
Code 25 Family Min. Length 	SS MS	Default (04) ◆ 01-Maximum Scan 2 digits from the option code chart in Appendix, then FuzzyScan will terminate this selection automatically.	FIN (2 digits)
Code 25 Family Max. Length 	SS MS	Default (98) ◆ 98-Minimum Scan 2 digits from the option code chart in Appendix, then FuzzyScan will terminate this selection automatically.	FIN (2 digits)

- For Code25 setting, we recommend you to select **only one** type of Code 25 or set the **maximum/minimum bar code length**. To decode all types of Code 25 or to variable length of Code 25 will increase the possibility of reading error.



PROGRAM

Symbology Reading Control Code 11 & Code 93 Setting



F_DEFAULT

Family Code Selection	P.C	Parameter Selection	Option Code
Code 11 Setting 	SS SS SS SS SS SS SS	Disable Code 11 ◆ Enable Code 11 Disable check digit verification ◆ Select 1-check digit verification Select 2-check digit verification Disable check digit transmission ◆ Enable check digit transmission	0 1 2 3 4 5 6
Code 11 Min. Length 	SS MS	Default (04) ◆ 01-Maximum Scan 2 digits from the option code chart in Appendix, then FuzzyScan will terminate this selection automatically.	FIN (2 digits)
Code 11 Max. Length 	SS MS	Default (98) ◆ 98-Minimum Scan 2 digits from the option code chart in Appendix, then FuzzyScan will terminate this selection automatically.	FIN (2 digits)
Code 93 Setting 	SS SS SS SS	Disable Code 93 Enable Code 93 ◆ Disable check digit transmission ◆ Enable check digit transmission	0 1 2 3
Code 93 Min. Length 	SS MS	Default (01) ◆ 01-Maximum Scan 2 digits from the option code chart in Appendix, then FuzzyScan will terminate this selection automatically.	FIN (2 digits)
Code 93 Max. Length 	SS MS	Default (98) ◆ 98-Minimum Scan 2 digits from the option code chart in Appendix, then FuzzyScan will terminate this selection automatically.	FIN (2 digits)



PROGRAM

Symbology Reading Control MSI/Plessey Setting



F_DEFAULT

Family Code Selection	P.C	Parameter Selection	Option Code
MSI/Plessey Setting 	SS	Disable MSI/Plessey ◆	0
	SS	Enable MSI/Plessey	1
	SS	Select MOD 10 check digit ◆	2
	SS	Select MOD 10-10 check digit	3
	SS	Select MOD 11-10 check digit	4
	SS	Disable check digit transmission ◆	5
	SS	Enable check digit transmission	6
MSI/Plessey Min. Length 	SS	Default (04) ◆	FIN (2 digits)
	MS	01-Maximum Scan 2 digits from the option code chart in Appendix, then FuzzyScan will terminate this selection automatically.	
MSI/Plessey Max. Length 	SS	Default (98) ◆	FIN (2 digits)
	MS	98-Minimum Scan 2 digits from the option code chart in Appendix, then FuzzyScan will terminate this selection automatically.	



PROGRAM

Symbology Reading Control Code 128 Setting



F_DEFAULT

Family Code Selection	P.C	Parameter Selection	Option Code
Code 128 Setting 	SS SS SS SS SS SS	Disable Code 128 Enable Code 128 ◆ ISBT Concatenation Off ◆ ISBT Concatenation On ISBT Concatenation On – Check ISBT table ISBT Concatenation Auto	0 1 2 3 4 5
Code 128 Min. Length 	SS MS	Default (01) ◆ 01-Maximum Scan 2 digits from the option code chart in Appendix, then FuzzyScan will terminate this selection automatically.	FIN (2 digits)
Code 128 Max. Length 	SS MS	Default (98) ◆ 98-Minimum Scan 2 digits from the option code chart in Appendix, then FuzzyScan will terminate this selection automatically.	FIN (2 digits)
Code 128 Security Level 	SS SS	Level 0 Level 1 ◆	0 1

▪ **Code 128 Setting**

ISBT Concatenation Off: The scanner will not output ISBT concatenated barcodes.

ISBT Concatenation On: The scanner will only decode and output ISBT concatenated barcodes. The scanner will not decode or output single ISBT barcodes.

ISBT Concatenation On – Check ISBT table: The scanner will only output ISBT concatenated barcodes that conform to ICCBBA standards. The scanner will not output single ISBT barcodes or ISBT concatenated barcodes that do not conform to ICCBBA standards.

ISBT Concatenation Auto: The Scanner will decode and output both ISBT concatenated barcodes and single ISBT barcodes.

▪ **Code 128 Security Level**

The scanner offers two levels of decode security for Code128 bar codes:

Level 0: If you are experiencing misread of poor-printed or out-of-spec. bar code in level1, please select level 0.

Level 1: This is the default setting which allows the scanner to operate fastest, while providing sufficient security in decoding "in-spec." Code128 bar codes.



PROGRAM

Symbology Reading Control GS1-128 Setting



F_DEFAULT

Family Code Selection	P.C	Parameter Selection	Option Code
GS1-128 Setting 	SS SS	Disable GS1-128 Enable GS1-128 ◆	0 1
GS1-128 Min. Length 	SS MS	Default (01) ◆ 01-Maximum Scan 2 digits from the option code chart in Appendix; then FuzzyScan will terminate this selection automatically.	FIN (2 digits)
GS1-128 Max. Length 	SS MS	Default (98) ◆ 98-Minimum Scan 2 digits from the option code chart in Appendix; then FuzzyScan will terminate this selection automatically.	FIN (2 digits)
GS1-128 Function Control 	SS SS SS SS SS SS SS SS SS SS	Disable GS1-128 special function ◆ Enable GS1-128 special function Disable First FNC1 transmission ◆ Enable First FNC1 convert to "JC1" and transmission Disable Application Identifier output ◆ Enable Application Identifier output Enable Application Identifier output with additional "(" Disable "DD=00" transmission when AI data field contains the date Enable "DD=00" transmission when AI data field contains the date ◆ Disable decimal point insert ◆ Enable decimal point insert	0 1 2 3 4 5 6 7 8 9 A

■ For First FNC1 transmission, chart of the FNC1 is provided in **Appendix-KeyBoard Function Code Table**. When the scanner is set to Keyboard Interface, the scanned code is converted to corresponding key function value before it is transmitted.



PROGRAM

Symbology Reading Control

GS1-128 Setting (continued)



F_DEFAULT

Family Code Selection	P.C	Parameter Selection	Option Code
GS1-128 FNC1 Setting 	SS SS MS	None ◆ GS (1DH) User defined character (1~2 characters)	0 1 2, [GS1-128 ASCII Table] [FIN]
GS1-128 Element String Separator 	SS MS	None ◆ User defined character (1~2 characters)	FIN [GS1-128 ASCII Table], [FIN]
GS1-128 Data Separator 	SS MS	None ◆ User defined character (1~2 characters)	FIN [GS1-128 ASCII Table], [FIN]
GS1-128 Error Converting 	SS SS	When the conversion from code 128 to GS1 128 is failed, the code 128 is not output ◆ When the conversion from code 128 to GS1 128 is failed, the code 128 is output directly without conversion	0 1



PROGRAM

Symbology Reading Control UK/Plessey Setting



F_DEFAULT

Family Code Selection	P.C	Parameter Selection	Option Code
UK/Plessey Setting 	SS	Disable UK/Plessey ◆	0
	SS	Enable UK/Plessey	1
	SS	Select UK/Plessey Standard Format ◆	2
	SS	Select UK/Plessey CLSI Format	3
	SS	Disable Convert X to A-F ◆	4
	SS	Enable Convert X to A-F	5
	SS	Disable check digit transmission ◆	6
	SS	Enable check digit transmission	7
UK/Plessey Min. Length 	SS MS	Default (04) ◆ 01-Maximum Scan 2 digits from the option code chart in Appendix, then FuzzyScan will terminate this selection automatically.	FIN (2 digits)
UK/Plessey Max. Length 	SS MS	Default (98) ◆ 98-Minimum Scan 2 digits from the option code chart in Appendix, then FuzzyScan will terminate this selection automatically.	FIN (2 digits)



PROGRAM

Symbology Reading Control Telepen Setting



F_DEFAULT

Family Code Selection	P.C	Parameter Selection	Option Code
Telepen Setting 	SS	Disable Telepen ◆	0
	SS	Enable Telepen	1
	SS	Select Telepen Numeric mode ◆	2
	SS	Select Telepen Full ASCII mode	3
	SS	Disable check digit transmission ◆	4
	SS	Enable check digit transmission	5
Telepen Min. Length 	SS	Default (04) ◆	FIN (2 digits)
	MS	01-Maximum Scan 2 digits from the option code chart in Appendix, then FuzzyScan will terminate this selection automatically.	
Telepen Max. Length 	SS	Default (98) ◆	FIN (2 digits)
	MS	98-Minimum Scan 2 digits from the option code chart in Appendix, then FuzzyScan will terminate this selection automatically.	



PROGRAM

Symbology Reading Control GS1 DataBar Setting



F_DEFAULT

Family Code Selection	P.C	Parameter Selection	Option Code
GS1 DataBar Setting 	SS	Disable GS1 DataBar (RSS-14)	0
	SS	Enable GS1 DataBar (RSS-14) ◆	1
	SS	Disable GS1 DataBar Limited	2
	SS	Enable GS1 DataBar Limited ◆	3
	SS	Disable GS1 DataBar Expanded	4
	SS	Enable GS1 DataBar Expanded ◆	5
GS1 DataBar Min. Length 	SS	Default (04) ◆	FIN (2 digits)
	MS	01- Maximum	
		Only available for Expanded GS1 Databar.	
		Scan 2 digits from the option code chart in Appendix, then FuzzyScan will terminate this selection automatically.	
GS1 DataBar Max. Length 	SS	Default (74) ◆	FIN (2 digits)
	MS	74-Minimum	
		Only available for Expanded GS1 Databar.	
		Scan 2 digits from the option code chart in Appendix, then FuzzyScan will terminate this selection automatically.	



PROGRAM

Symbology Reading Control Composite Codes, Codablock F, & PDF417/MicroPDF417 Setting



F_DEFAULT

Family Code Selection	P.C	Parameter Selection	Option Code
Composite Codes Setting 	SS SS SS SS	Disable composite codes ◆ Enable composite codes UPC Composite Mode: UPC never linked ◆ UPC Composite Mode: UPC always linked If UPC Composite Mode: UPC never linked is selected, UPC barcodes are transmitted whether MicroPDF417 symbol is detected or not. If UPC Composite Mode: UPC always linked is selected, UPC barcodes are only transmitted when the MicroPDF417 is detected.	0 1 2 3
Codablock F Setting 	SS SS	Disable ◆ Enable	0 1
PDF417/Micro PDF417 Setting 	SS SS SS SS	Disable PDF417 Enable PDF417 ◆ Disable MicroPDF417 ◆ Enable MicroPDF417	0 1 2 3



PROGRAM

Symbology Reading Control Code 16K & Code 49 Setting



F_DEFAULT

Family Code Selection	P.C	Parameter Selection	Option Code
Code 16K Setting 	SS SS	Disable Code 16K ◆ Enable Code 16K	0 1
Code 16K Min. Length 	SS MS	Default (01) ◆ 01-Maximum Scan 3 digits from the option code chart in Appendix; then FuzzyScan will terminate this selection automatically.	FIN (3 digits)
Code 16K Max. Length 	SS MS	Default (160) ◆ 160-Minimum Scan 3 digits from the option code chart in Appendix; then FuzzyScan will terminate this selection automatically.	FIN (3 digits)
Code 49 Setting 	SS SS	Disable Code 49 ◆ Enable Code 49	0 1
Code 49 Min. Length 	SS MS	Default (01) ◆ 01-Maximum Scan 2 digits from the option code chart in Appendix; then FuzzyScan will terminate this selection automatically.	FIN (2 digits)
Code 49 Max. Length 	SS MS	Default (81) ◆ 81-Minimum Scan 2 digits from the option code chart in Appendix; then FuzzyScan will terminate this selection automatically.	FIN (2 digits)



PROGRAM

Symbology Reading Control (A Series & PA Series)



F_DEFAULT

QR Code Setting

Family Code Selection	P.C	Parameter Selection	Option Code
QR Code Setting 	SS SS	Disable QR Code Enable QR Code ◆ Disable MicroQR Code Enable MicroQR Code ◆ Disable QR Code Append Enable QR Code Append ◆ Disable QR Code Inverse Reading Enable QR Code Inverse Reading Auto detect QR Code Inverse Reading ◆ Disable QR Code Mirror Images Enable QR Code Mirror Images Auto detect QR Code Mirror Images ◆	0 1 2 3 4 5 6 7 8 9 A B
QR Code Min. Length 	SS MS	Default (01) ◆ 01-Maximum Scan 4 digits from the option code chart in Appendix; then FuzzyScan will terminate this selection automatically.	FIN (4 digits)
QR Code Max. Length 	SS MS	Default (7089) ◆ 7089-Minimum Scan 4 digits from the option code chart in Appendix; then FuzzyScan will terminate this selection automatically.	FIN (4 digits)

- **QR Code Inverse Reading:** When **Enabled**, the scanner only read inversed (white on black) QR codes. If **Auto detect** is selected the scanner can read both normal and inversed QR codes. However, Auto detect might increase decoding time under certain circumstances.
- **QR Code Mirror Images:** When **Enabled**, the scanner only read mirrored QR and Micro QR codes. If **Auto detect** is selected the scanner can read both normal and mirrored QR/Micro QR codes. However, Auto detect might increase decoding time under certain circumstances.



PROGRAM

Symbology Reading Control
(A Series & PA Series)



F_DEFAULT

Data Matrix Setting

11Family Code Selection	P.C	Parameter Selection	Option Code
Data Matrix Setting 	SS SS SS SS SS SS SS SS	Disable Data Matrix Enable Data Matrix ◆ Disable Data Matrix Inverse Reading Enable Data Matrix Inverse Reading Auto Detect Data Matrix Inverse Reading ◆ Disable Data Matrix Mirror Images Enable Data Matrix Mirror Images Auto Detect Data Matrix Mirror Images ◆	0 1 4 5 6 7 8 9
Data Matrix Min. Length 	SS MS	Default (01) ◆ 01-Maximum Scan 4 digits from the option code chart in Appendix; then FuzzyScan will terminate this selection automatically.	FIN (4 digits)
Data Matrix Max. Length 	SS MS	Default (3116) ◆ 3116-Minimum Scan 4 digits from the option code chart in Appendix; then FuzzyScan will terminate this selection automatically.	FIN (4 digits)
Damaged DM Code Reading 	SS SS	Disable ◆ Enable	0 1

- **Data Matrix Inverse Reading:** When **Enabled**, the scanner only read inversed (white on black) Data Matrix. If **Auto detect** is selected the scanner can read both normal and inversed Data Matrix. However, Auto detect might increase decoding time under certain circumstances.
- **Data Matrix Mirror Images:** When **Enabled**, the scanner only read mirrored Data Matrix. If **Auto detect** is selected the scanner can read both normal and mirrored Data Matrix. However, Auto detect might increase decoding time under certain circumstances.
- **Damaged DM Code Reading:** When using 2D scanner to read small or damaged DataMatrix, you can enable this function to improve the scanner's reading ability. Be aware that the scanner's snapiness decreases when the function is enabled.



PROGRAM

Symbology Reading Control (A Series & PA Series)



F_DEFAULT

MaxiCode Setting

Family Code Selection	P.C	Parameter Selection	Option Code
MaxiCode Setting 	SS SS	Disable MaxiCode ◆ Enable MaxiCode	0 1
MaxiCode Min. Length 	SS MS	Default (01) ◆ 01-Maximum Scan 3 digits from the option code chart in Appendix, then FuzzyScan will terminate this selection automatically.	FIN (3 digits)
MaxiCode Max. Length 	SS MS	Default (150) ◆ 150-Minimum Scan 3 digits from the option code chart in Appendix, then FuzzyScan will terminate this selection automatically.	FIN (3 digits)



PROGRAM

Symbology Reading Control (A Series & PA Series)



F_DEFAULT

Aztec Code Setting

Family Code Selection	P.C	Parameter Selection	Option Code
Aztec Code Setting 	SS SS	Disable Aztec Code Enable Aztec Code ◆	0 1
Aztec Code Min. Length 	SS MS	Default (01) ◆ 01-Maximum Scan 4 digits from the option code chart in Appendix; then FuzzyScan will terminate this selection automatically.	FIN (4 digits)
Aztec Code Max. Length 	SS MS	Default (3832) ◆ 3832-Minimum Scan 4 digits from the option code chart in Appendix; then FuzzyScan will terminate this selection automatically.	FIN (4 digits)



PROGRAM

Symbology Reading Control (A Series & PA Series)



F_DEFAULT

Australian Post, US Planet, US Postnet, British Post & Japan Post Setting

Family Code Selection	P.C	Parameter Selection	Option Code
Australian Post Setting 	SS	Disable Australian Post ◆	0
	SS	Enable Australian Post	1
	SS	Raw format Output ◆	2
	SS	Numeric Encoding Output (N Encoding Table)	3
	SS	Alphanumeric Encoding Output (C Encoding Table)	4
	SS	Auto-discriminate Output (Combination C & N Encoding Table)	5
US Planet Setting 	SS	Disable US Planet ◆	0
	SS	Enable US Planet	1
	SS	Disable Check Digit Transmission ◆	2
	SS	Enable Check Digit Transmission	3
US Postnet Setting 	SS	Disable US Postnet ◆	0
	SS	Enable US Postnet	1
	SS	Disable Check Digit Transmission ◆	2
	SS	Enable Check Digit Transmission	3
British Post Setting 	SS	Disable British Post ◆	0
	SS	Enable British Post	1
	SS	Disable Check Digit Transmission ◆	2
	SS	Enable Check Digit Transmission	3
Japan Post Setting 	SS	Disable Japan Post ◆	0
	SS	Enable Japan Post	1

▪ **Australian Post Setting:** Auto-discriminate output option increase the risk of misread because the encoded data format does not specify the Encoding Table used for encoding.





PROGRAM

Symbology Reading Control (A Series & PA Series)



F_DEFAULT

Netherlands KIX Code, Intelligent Mail & Korea Post Code Setting

Family Code Selection	P.C	Parameter Selection	Option Code
Netherlands KIX Code Setting 	SS SS	Disable Netherlands KIX Code ◆ Enable Netherlands KIX Code	0 1
Intelligent Mail Setting (USPS 4CB/One Code) 	SS SS	Disable Intelligent Mail ◆ Enable Intelligent Mail	0 1
Korea Post Code Setting 	SS SS	Disable ◆ Enable Length fixed in 6 characters.	0 1



PROGRAM

Keyboard Interface Control Keyboard Layout (Language) Setting



F_DEFAULT

Family Code Selection	P.C	Parameter Selection	Option Code
Keyboard Layout 	SS	USA (QWERTY) ◆	00
	SS	France (AZERTY)	01
	SS	Germany (QWERTZ)	02
	SS	United Kingdom - UK (QWERTY)	03
	SS	Canadian French (QWERTY)	04
	SS	Spain (Spanish, QWERTY)	05
	SS	Sweden/Finland (QWERTY)	06
	SS	Portugal (QWERTY)	07
	SS	Norway (QWERTY)	08
	SS	Spain (Latin America, QWERTY)	09
	SS	Italy (QWERTY)	10
	SS	Netherlands (QWERTY)	11
	SS	Denmark (QWERTY)	12
	SS	Belgium (AZERTY)	13
	SS	Switzerland-Germany (QWERTZ)	14
	SS	Iceland (QWERTY)	15
	SS	Japan (DOS/V)	16
SS	Czech (QWERTY)	17	
SS	Universal	99	

Please refer to the **ASCII/HEX Table** listed in the Appendix to determine HEX codes for characters, symbols, and functions to be used as preamble or postamble. To set preamble or postamble as function key output, you must enable the **“Function Key Emulation”** feature as listed in page 77 first

- When Universal is selected, ASCII and Extended ASCII characters are sent as sequence of alt key plus numeric keypad value. This is only valid for Windows OS.
- **Keyboard Interface Message String :**

Preamble	Data Length	Prefix Symbol ID	Scanned Data	Suffix Symbol ID	Postamble	Record Suffix
1-15 characters	2-4 digits	1 or 3 characters	Variable length	1 or 3 characters	1-15 characters	1 character



PROGRAM

Keyboard Interface Control

Record Suffix, Preamble, Postamble, & FNC1 Symbol Character Transmit



F_DEFAULT

Family Code Selection	P.C	Parameter Selection	Option Code
Record Suffix 	SS SS SS SS SS SS	None RETURN ◆ TAB SPACE ENTER (Numeric Key Pad) User defined character (1 character)	0 1 2 3 4 5, (00-7F)
Preamble 	SS MS	None ◆ 1-15 characters Maximum 15-character input; scan "FIN" to terminate this selection.	FIN [00-7F], [FIN]
Postamble 	SS MS	None ◆ 1-15 characters Maximum 15-character input; scan "FIN" to terminate this selection.	FIN [00-7F], [FIN]
FNC1 Symbol Char. Transmit 	SS SS	Disable Enable ◆	0 1

▪ **FNC1 Symbol Char. Transmit:** When this function is enabled and the FNC1 is contained in scanned data, the scanner transmits the FNC1 to the host. Chart of the FNC1 is provided in Appendix- Keyboard Function Code Table. When the scanner interface is set to keyboard, the scan code is converted to corresponding key function before it is transmitted.



PROGRAM

Keyboard Interface Control Caps Lock & Caps Lock Release Control



F_DEFAULT

Family Code Selection	P.C	Parameter Selection	Option Code
Caps Lock Control 	SS SS SS	"Caps Lock Off" State ◆ "Caps Lock On" State Auto Detect (PC/AT, PS/2, Keyboard Replacement and DOS/V Machines only)	0 1 2
Caps Lock Release Control 	SS SS	"Caps Lock On, Caps Off" ◆ "Caps Lock On, Shift Off"	0 1

- The function of "Caps Lock Control" is **only** available for IBM PC/AT, PS/VP, PS/2 series personal computers and compatible machines. While selecting the other host interfaces, these selections don't perform the above functions for you.
- Please check the **actual** Caps Lock state in use while software application is running. If the Caps Lock state is off, select "Caps Lock Off" state, then FuzzyScan will perform normal data transmission. If the Caps Lock state is on, select "Caps Lock On" state. Select "Auto Detect", FuzzyScan will perform special transmission handshaking without changing the status of Caps Lock switch.



PROGRAM

Keyboard Interface Control Delay Setting



F_DEFAULT

Family Code Selection	P.C	Parameter Selection	Option Code
Intermessage Delay 	SS MS	None ◆ 1-99 (x10) msec. Scan 2 digits from the option code chart in Appendix, then FuzzyScan will terminate this selection automatically.	FIN (2 digits)
Intercharacter Delay 	SS MS	None ◆ 1-99 (x5) msec. Scan 2 digits from the option code chart in Appendix, then FuzzyScan will terminate this selection automatically.	FIN (2 digits)
Interfunction Delay 	SS MS	None ◆ 1-99 (x5) msec. Scan 2 digits from the option code chart in Appendix, then FuzzyScan will terminate this selection automatically.	FIN (2 digits)

- **Intermessage Delay** is a time delay between messages output by FuzzyScan. Increasing this delay will help host applications process the incoming data on time.
- **Intercharacter Delay** is a time delay between data characters output by FuzzyScan. This parameter is used to synchronize data communication when : 1) the data transmission speed is too fast, characters may be skipped; 2) multitasking operation system or host computers in a network may slow down the keyboard handling; 3) various notebook or desktop PC systems require different timing parameter settings. Please always add one extra unit as safety margin when adjusting this parameter
- **Interfunction Delay** is a time delay between the transmissions of each segment of the message string.
- **Intermessage Delay, Intercharacter Delay, and Interfunction Delay** are unconfigurable under SPP and HID modes.



PROGRAM

Keyboard Interface Control

Function Key & Key Pad Emulation, Upper/Lower Case & Dollar Sign Control



F_DEFAULT

Family Code Selection	P.C	Parameter Selection	Option Code
Function Key Emulation 	SS SS SS	Enable Keyboard Function Code Table 1 Output ◆ Enable Keyboard Function Code Table 2 Output (Ctrl-Output) Enable Keyboard Function Code Table 3 Output Refer to Appendix – Keyboard Function Code Table for details.	0 1 2
Key Pad Emulation 	SS SS	Disable key pad emulation ◆ Enable numeric output as key pad (Num Lock On) output	0 1
Upper/Lower Case 	SS SS SS SS	Normal case (neglect the upper/lower case control) ◆ Inverse case (change all characters output to inverse case) Upper case (force all characters output as upper case) Lower case (force all characters output as lower case)	0 1 2 3
Dollar Sign Control 	SS SS SS SS SS	Dollar sign output as “ \$ ” ◆ Dollar sign output as “ ¥ ” Dollar sign output as “ € ” Dollar sign output as “ £ ” Dollar sign output as “ ¢ ”	0 1 2 3 4

▪ The function of “Key Pad Emulation” is **only** available for IBM PC/AT, PS/VP, PS/2 series personal computers and compatible machines. While selecting the other host interfaces, these selections don't perform the above functions for you.



PROGRAM

Keyboard Interface Control

Code Page: Barcode Encoding Format, Keyboard Output



F_DEFAULT

Family Code Selection	P.C	Parameter Selection	Option Code
Barcode Encoding Format 	MS	UTF8	00
		Code page 950	10
		Code page 949	11
		Code page 936	12
		Code page 932	13
		Code page 874	14
		WIN1250	15
		WIN1251	16
		WIN1252 ◆	17
		WIN1253	18
		WIN1254	19
		WIN1255	1a
		WIN1256	1b
		WIN1257	1c
		WIN1258	1d
		ISO 8859-1 Latin 1, Western European	1e
		ISO 8859-2 Latin 2, Central European	1f
		ISO 8859-3 Latin 3, Southern European	20
		ISO 8859-4 Latin 4, Northern European	21
		ISO 8859-5 Cyrillic	22
		ISO 8859-6 Arabic	23
		ISO 8859-7 Greek	24
		ISO 8859-8 Hebrew	25
		ISO 8859-9 Latin 5, Turkish	26
		ISO 8859-10 Latin 6, Nordic	27
		ISO 8859-11 Thai	28
		ISO 8859-13 Latin 7, Baltic	29



		ISO 8859-14 Latin 8, Celtic	2a
		ISO 8859-15 Latin 9	2b
		ISO 8859-16 Latin 10, South-Eastern European	2c
<p>Keyboard Output</p>	MS	Linux Unicode Output	00
		MAC Unicode Output	01
		WIN Notepad Unicode Output	02
		WIN Wordpad Unicode Output	03
		Code page 950 Output	10
		Code page 949 Output	11
		Code page 936 Output	12
		Code page 932 Output	13
		Code page 874 Output	14
		WIN1250 Output	15
		WIN1251 Output	16
		WIN1252 Output ◆	17
		WIN1253 Output	18
		WIN1254 Output	19
		Code page 852 Output	30
		Code page 855 Output	31
		Code page 866 Output	32
		Code page 850 Output	33
		Code page 437 Output	34
		Code page 737 Output	35
		Code page 857 Output	36
		Code page 862 Output	37
		Code page 720 Output	38
		Code page 775 Output	39
		WIN1255 Output	1a
		WIN1256 Output	1b
		WIN1257 Output	1c
WIN1258 Output	1d		

- **Corresponding Languages:** Please see Appendix below, “Code Page - Table of Corresponding Languages”.
- **Barcode Encoding Format:** 2D barcodes can be encoded using different code pages. To properly decode the data of a 2D barcode, the scanner must first be set to the corresponding code page of such data. Select UTF8 if the 2D barcode was encoded in Unicode (UTF-8).
- **Keyboard Output:** Different languages use different code pages. For your scanner to properly display the content of a 2D barcode, select the code page that corresponds to the content’s language. Please check your system locale setting in Windows and make sure that it also matches this language.
 - 1) Mac Device Output: If your host is a Mac device, select “MAC Unicode Output” as the scanner’s output setting (the data will be in Unicode). You must also first ensure that your Mac device has the required Unicode Hex Input Setup and is configured for the 16-bit input method. Please see Appendix below, “Code Page - Unicode Hex Input Setup”.
 - 2) WIN Notepad Unicode Output: If your host is a Windows device, you can output the data in Unicode format to Notepad. You must first ensure that your Windows device has the required Unicode Hex Input Setup, and is set to the US English input method. Please see Appendix below, “Code Page - Unicode Hex Input Setup”.
 - 3) WIN WordPad Unicode Output: If your host is a Windows device, you can output the data in Unicode format to WordPad. You must first ensure that your Windows device is set to the US English input method.



PROGRAM

Serial Interface Control

Record Suffix, Preamble, Postamble Setting



F_DEFAULT

Family Code Selection	P.C	Parameter Selection	Option Code
STX/ETX Control 	SS SS	Disable STX/ETX transmission ◆ Enable STX/ETX transmission STX/ETX are two characters used to indicate the starting and ending of the total data frame transmitted via serial interface.	0 1
Record Suffix 	SS SS SS SS SS SS MS	None CR (0DH) ◆ LF (0AH) CRLF (0D0AH) TAB (09H) SPACE (20H) User defined character (1 character)	0 1 2 3 4 5 6, (00-7F)
Preamble 	SS MS	None ◆ 1-15 characters Maximum 15-character input; scan "FIN" to terminate this selection.	FIN [00-7F], [FIN]
Postamble 	SS MS	None ◆ 1-15 characters Maximum 15-character input; scan "FIN" to terminate this selection.	FIN [00-7F], [FIN]
FNC1 Symbol Char. Transmit 	SS SS	Disable Enable ◆ When this function is enabled and the FNC1 is contained in scanned data, the scanner transmits the FNC1 to the host. Chart of the FNC1 is provided in Appendix – Keyboard Function Code Table. When the scanner interface is set to keyboard, the scan code is converted to corresponding key function before it is transmitted	0 1

▪ Serial Interface Message String (RS232, USB COM) :

STX	Preamble	Data Length	Prefix Symbol ID	Scanned Data	Suffix Symbol ID	Postamble	ETX	Record Suffix
1 character	1-15 characters	2-4 digits	1 or 3 characters	Variable length	1 or 3 characters	1-15 characters	1 character	1 character



PROGRAM

Serial Interface Control Delay Setting



F_DEFAULT

Family Code Selection	P.C	Parameter Selection	Option Code
Intermessage Delay 	SS MS	None ◆ 1-99 (x10) msec. Scan 2 digits from the option code chart in Appendix, then FuzzyScan will terminate this selection automatically.	FIN (2 digits)
Intercharacter Delay 	SS MS	None ◆ 1-99 (x5) msec. Scan 2 digits from the option code chart in Appendix, then FuzzyScan will terminate this selection automatically.	FIN (2 digits)
Interfunction Delay 	SS MS	None ◆ 1-99 (x5) msec. Scan 2 digits from the option code chart in Appendix, then FuzzyScan will terminate this selection automatically.	FIN (2 digits)

- **Intermessage Delay** is a time delay between messages output by FuzzyScan. Increasing this delay will help host applications process the incoming data on time.
- **Intercharacter Delay** is a time delay between data characters output by FuzzyScan. These two parameters are used to synchronize data communication when : 1) the data transmission speed is too fast, characters may be skipped; 2) multitasking operation system or host computers in a network may slow down the keyboard handling; 3) various notebook or desktop PC systems require different timing parameter settings. Please always add one extra unit as safety margin when adjusting these two parameters.
- **Interfunction Delay** is a time delay between the transmissions of each segment of the message string.
- **Intermessage Delay**, **Intercharacter Delay** and **Interfunction Delay** are unconfigurable under SPP and HID modes.



PROGRAM

Serial Interface Control Protocol, ACK/NAK Setting



F_DEFAULT

Family Code Selection	P.C	Parameter Selection	Option Code
Handshaking Protocol 	SS SS SS SS	None (free running mode) ◆ RTS/CTS (hardware handshaking) ACK/NAK (software handshaking) Xon/Xoff (software handshaking)	0 1 2 3
NAK Retry Count 	SS SS	3 times ◆ 0~255 times	FIN (3 digits)
ACK Indication 	SS SS SS SS	Disable ACK Time-out Indication Enable ACK Time-out Indication ◆ Disable ACK Indication ◆ Enable ACK Indication	0 1 2 3

- USB COM doesn't support RTS/CTS handshaking protocol.
- When the **ACK/NAK Software Handshaking** option is selected, the FuzzyScan waits for an **ACK** (acknowledge) or **NAK** (not acknowledge) from the host computer after each data transmission. If the NAK is received, FuzzyScan will re-send the data until receiving ACK.
 ACK/NAK handshaking protocol is workable under following conditions:
 - 1) Pair mode by using RS232 or USB COM interface.
 - 2) SPP master or slave mode.
- **NAK Retry Count**
 After transmitting data, the scanner expects a NAK response from the host up to the preset "Serial Response Time-out". If the scanner doesn't get a response, the scanner will issue an error indication and discard the data. When a NAK is received, the scanner transmits the same data again and waits for either an ACK or NAK. The scanner issues an error indication and discards the data under following two conditions:
 - 1) After preset NAK retry counts is received within the preset serial response time-out.
 - 2) If the preset time-out is up but the preset NAK retry counts haven't come to the end.
 The default retry counts are three times. If you program "0 time", the scanner won't resend the data to the host when the scanner receives a NAK. The scanner will discard the data. If you program "255 times", the scanner can receive unlimited NAKs from the host within the pre-set serial response time-out.
 This function is not available for batch mode. When you enable this function in on-line mode, the out-of-range function will be disable automatically.
- **ACK Indication:**
 Disable: There's neither LED nor beeping indication for this setting.
 Enable: There's a specific LED and beeping indication for this setting.



PROGRAM

Serial Interface Control

Time Out Setting, Baud Rate, Data Frame



F_DEFAULT

Family Code Selection	P.C	Parameter Selection		Option Code	
Serial Response Time-out 	MS SS SS SS SS SS	None 200 msec 500 msec ◆ 800 msec 1 second 2 seconds	3 seconds 4 seconds 5 seconds 8 seconds 10 seconds 15 seconds	0 1 2 3 4 5	6 7 8 9 A B
Baud Rate (BPS) 	SS SS SS SS	38.4K BPS 19.2K BPS 9600 BPS ◆ 4800 BPS	2400 BPS 1200 BPS 57.6K BPS 115.2K BPS	0 1 2 3	4 5 8 9
Data Frame 	SS SS SS SS SS SS SS SS	8, None, 1 ◆ 8, Odd, 1 8, Even, 1 8, Space, 1 8, Mark, 1 8, None, 2 7, Odd, 1 7, Even, 1	7, Space, 1 7, Mark, 1 7, None, 2 7, Odd, 2 7, Even, 2 7, Space, 2 7, Mark, 2	0 1 2 3 4 5 6 7	8 9 A B C D E

- When the **RTS/CTS Hardware Handshaking** option is selected, the **RTS** (request to send) and **CTS** (clear to send) signals will be issued before normal data communication. This option is very helpful to ensure the reliability of data communication.
- The **Serial Response Time-out** is a pre-defined delay time for FuzzyScan to wait for handshaking, acknowledgment or non-acknowledgment from the host computer.



PROGRAM

**Serial Interface Control
(A Series & PA Series)**



F_DEFAULT

**Code Page: Barcode Encoding Format,
Serial Port Output**

Family Code Selection	P.C	Parameter Selection	Option Code
Barcode Encoding Format 	MS	UTF8	00
		Code page 950	10
		Code page 949	11
		Code page 936	12
		Code page 932	13
		Code page 874	14
		WIN1250	15
		WIN1251	16
		WIN1252 ◆	17
		WIN1253	18
		WIN1254	19
		WIN1255	1a
		WIN1256	1b
		WIN1257	1c
		WIN1258	1d
		ISO 8859-1 Latin 1, Western European	1e
		ISO 8859-2 Latin 2, Central European	1f
		ISO 8859-3 Latin 3, Southern European	20
		ISO 8859-4 Latin 4, Northern European	21
		ISO 8859-5 Cyrillic	22
		ISO 8859-6 Arabic	23
		ISO 8859-7 Greek	24
		ISO 8859-8 Hebrew	25

		ISO 8859-9 Latin 5, Turkish	26
		ISO 8859-10 Latin 6, Nordic	27
		ISO 8859-11 Thai	28
		ISO 8859-13 Latin 7, Baltic	29
		ISO 8859-14 Latin 8, Celtic	2a
		ISO 8859-15 Latin 9	2b
		ISO 8859-16 Latin 10, South-Eastern European	2c
	<p>Serial Port Output</p> <p>MS</p>	Raw Data ◆	00
		Unicode (Big Endian)	01
		Unicode (Little Endian)	02
		UTF8	03
		CP950 Output (Big Endian)	10
		CP949 Output (Big Endian)	11
		CP936 Output (Big Endian)	12
		CP932 Output (Big Endian)	13
		CP874 Output	14
		WIN1250 Output	15
		WIN1251 Output	16
		WIN1252 Output	17
		WIN1253 Output	18
		WIN1254 Output	19
		WIN1255 Output	1A
		WIN1256 Output	1B
		WIN1257 Output	1C
		WIN1258 Output	1D
		CP852	30
		CP855	31
	CP866	32	
	CP850	33	
	CP437	34	



	CP737	35
	CP857	36
	CP862	37
	CP720	38
	CP775	39
	CP950 Output (Little Endian)	90
	CP949 Output (Little Endian)	91
	CP936 Output (Little Endian)	92
	CP932 Output (Little Endian)	93

▪ To get multilingual output with the serial interface, please choose correct barcode encoding format and its corresponding serial port output format.



PROGRAM

Wand/Laser Emulation Control (F, L, PF & PL)



F_DEFAULT

Output Polarity, Signal State, Margin/Module Time

Family Code Selection	P.C	Parameter Selection	Option Code
Output Polarity 	SS SS	High level (5Vdc) on Bar (low level on Space) ◆ Low level (0Vdc) on Bar (high level on Space) Determine the output voltage level for both bar and space.	0 1
Initial Signal State 	SS SS	High Level (5Vdc) ◆ Low Level (0Vdc) Determine the initial state of output voltage level.	0 1
Margin Time 	SS SS SS SS SS	10 msec. 15 msec. 20 msec. ◆ 25 msec. 30 msec.	0 1 2 3 4
Module Time 	SS SS SS SS	Extremely short Short Medium ◆ Long	0 1 2 3
Narrow/Wide Ratio 	SS SS SS	1:2 ◆ 1:2.5 1:3	0 1 2



PROGRAM

Wand/Laser Emulation Control

(F, L, PF, PL & PA Series)

Code 39/Code 128 Emulation



F_DEFAULT

Family Code Selection	P.C	Parameter Selection	Option Code
Code 39/Code 128 Emulation 	SS	Disable standard Code 39 emulation ◆	0
	SS	Enable standard Code 39 skip emulation	1
	SS	Enable standard Code 39 replace emulation	2
	SS	Enable Full ASCII Code 39 emulation	3
	SS	Enable Code 128 emulation	4

- **Code 39 Skip:** When this option is selected, all scanned data will be translated as Standard Code 39 wand/laser emulation output. If any lower case characters are read, they will be translated to upper case characters. Any other characters that are not available in Code 39 symbology set will be **skipped**.
- **Code 39 Replace:** Any character not normally available in the standard Code 39 symbology set, will be translated as **Space**.



PROGRAM

Operation Control Operation Mode



F_DEFAULT

Family Code Selection	P.C	Parameter Selection	Option Code
Operation Mode 	SS SS SS	Trigger mode ◆ Presentation mode Multiple Read mode <i>PF / PL / PA series do not support Presentation Mode</i>	1 2 C

- **Trigger Mode (Low Power Triggering)** The scanner goes into standby state after scanning the barcode. You must press the trigger to turn on the light source of the scanner before scanning the bar code.
- **Presentation Mode (Auto Detection)** Presentation mode uses ambient light to detect the barcodes. The light source is off until the scanner detects an image which is similar to a barcode. Then the light source turns on automatically to read the barcode. If the light level in the room is not high enough, Presentation Mode may not work properly. You can choose different level of "Presentation Sensitivity" to meet your application (Please refer to the setting of "**Presentation Sensitivity**").
- **Multiple Read Mode** The scanner is allowed to decode multiple barcodes with a single pull of the trigger. When you press and hold the trigger to aim at a series of barcodes, the scanner will decode each barcode and beep for each good read. For more precise barcode decoding, you are recommended to enable **Center Alignment** function while multiple read mode is selected. You can enable **Unique Barcode Reporting** function to avoid reading the same code multiple times in a same scanning session.



PROGRAM

Operation Control
(A Series & PA Series)

Batch Reading



F_DEFAULT

Family Code Selection	P.C	Parameter Selection	Option Code
<p>Batch Reading</p>	SS	None ◆ Batch Reading rule input (01-16 rules)	[FIN] [Rules] [FIN]

▪ **Batch Reading:** When this function is enabled, you can scan multiple barcodes one by one continuously upon one trigger event. The scanner reports a good read beep and indication only if all bar codes set by the “Batch Reading Rule” are read. Otherwise, the scanner reports an error beep and indication. The scanned data will be transmitted according to the preset sequence which is defined in “Batch Reading Rule” regardless the scanned order of those barcodes.

- Batch Reading function is only available **Trigger Mode**.
- Batch Reading is not available when **Multiple Read Mode** or **Center Alignment** is turned on.

▪ **Batch Reading Rule:**

- To set the Batch Reading rule
 1. Scan the **PROGRAM** symbol.
 2. Scan the **Batch Reading** symbol (Family Code).
 3. Use the **Option Code** to define the preset Batch Reading rule.
 4. Scan the **FIN** symbol.
 5. Scan the **END** symbol to save your Batch Reading rule.

Note: Scan the **ABORT** and **END** symbol to exit without saving any Batch Reading rule setting.

- When you scan “None”, the preset Batch Reading Rule will be cancelled.

- Batch Reading Rule Syntax:

[n] [Element 1] FF [Element 2] FF [Element 3] FF ...[Element n] FF

Where **n** is the number of elements in the overall rule. The number of elements is up to 16. **FF** indicates the end of one element.

- Element structure:

[Cino ID Hex value] [Code length] [Character match(es)]

Where:

- **[Cino ID Hex value]**

Length: 2 byte

Please find Cino ID hex value from **Symbology ID Table** in appendix. Locate the Hex value for the symbology and scan the 2 digit hex values from the **Option Code**.

Note: 99 is the universal number, indicating all symbologies.

- **[Code length]**
Length: 4 byte
Specify what length of data output will be acceptable for this symbology. When you calculate the length, you must consider the whole data string which includes the programmed Preamble, Postamble, Scanned Data Length, Prefix/Suffix Symbol ID or AIM ID. Scan the four digit data length from the **Option Code**.
Note: 40 characters is entered as 0040; 9999 is a universal number, indicating all lengths.
- **[Character match]**
Length: 2-8 byte
You can refer to **HEX/ASCII Reference Table** to find the Hex value that represents the character(s) you want to match. Use the **Option Code** to scan the alphanumeric combination that represents the ASCII characters. You can match up to 4 characters which are counted from the start character of the whole **Data String**.
Note: When setting the matched character(s), you must match the content of the whole Data String, including the programmed Preamble, Postamble, Scanned Data Length, Prefix/Suffi Symbol ID OR AIM ID if you had defined. **FF** is the universal character, indicating all characters.
- **Batch Reading rule example**
In this example, you are scanning Code 39, Code 128, and Code 93 bar codes, but you would like to output the data in following sequence:
Code 128 - Code 39 - Code 93



B-CODE39



A-CODE128



C-CODE93

You would set up the Batch Reading rule with the following command line:

```
[PROGRAM] [Batch Reading] [0301999941FF07999942FF09999943FF] [FIN] [END]
```

The breakdown of the command line is shown below:

03	The number of elements in the overall rule
01	Code identifier of Code 128
9999	Code length that must match for Code 128, 9999 = all lengths
41	Start character match for Code 128, 41h = "A"
FF	End of first code
07	Code identifier of Code 39
9999	Code length that must match for Code 39, 9999 = all lengths
42	Start character that must match for Code 39, 42h = "B"
FF	End of second code
09	Code identifier of Code 93
9999	Code length that must match for Code 93, 9999 = all lengths
43	Start character match for Code 93, 43h = "C"
FF	End of third code

To program the previous example using specific lengths, you would have to count the programmed Preamble, Postamble, Scanned Data Length, Prefix/Suffix Symbol ID OR AIM ID if you had defined as part of the length. If you enable the Suffix Symbol ID of symbology, you would add one character to the previous example's length.

You would set up the Batch Reading rule with the following command line:

```
[PROGRAM] [Batch Reading] [0301001041FF070009FF09000943FF] [FIN] [END]
```



The breakdown of the command line is shown below:

- 03 The number of elements in the overall rule
- 01 Code identifier of Code 128
- 0010 Code length that must match for Code 128
 A-CODE128 sample length (9) plus Suffix Symbol ID (1) = 10
- 41 Start character match for Code 128, 41h = "A"
- FF End of first code
- 07 Code identifier of Code 39
- 0009 Code length that must match for Code 39
 B-CODE39 sample length (8) plus Suffix Symbol ID (1) = 9
- FF Universal matched character, indicating all character
 Also indicate end of second code
- 09 Code identifier of Code 93
- 0009 Code length that must match for Code 93
 C-CODE93 sample length (8) plus Suffix Symbol ID (1) = 9
- 43 Start character match for Code 93, 43h = "C"
- FF End of third code

Note: If the [Character match(es)] is set to "FF", the following "FF" which indicated the end of the code was not need to set.

- Structure of **Data String**

STX (RS232/USB COM interface)	Preamble	Scanned Data Length	Prefix Symbol ID Or Prefix AIM Symbol ID	Scanned Data modified by DataWizard	Suffix Symbol ID Or Suffix AIM Symbol ID	Postamble	ETX (RS232/USB COM interface)
1 character	1-15 characters	2-4 digits	1 or 3 characters	Variable length	1 or 3 characters	1-15 characters	1 character



PROGRAM

Operation Control (All Series)



F_DEFAULT

Buzzer, Indicator, Vibrator, 1D Code Inverse Reading

Family Code Selection	P.C	Parameter Selection	Option Code
Buzzer Tone Adjust 	SS	Buzzer tone – mute	0
	SS	Buzzer tone – low (Frequency 1.20 kHz)	1
	SS	Buzzer tone – medium (Frequency 2.70 kHz) ◆	2
	SS	Buzzer tone – high (Frequency 2.81 kHz)	3
	SS	Buzzer tone - extremely high (Frequency 2.93 kHz)	4
	SS	Power-on / power-off beep ◆	5
	SS	No power-on / power-off beep	6
Power On Indicator 	SS	Disable (LED off)	0
	SS	LED steady on ◆	1
	SS	LED flash	2
Good Read Indicator 	SS	Disable	0
	SS	Enable ◆	1
Vibrator Control 	SS	Disable	0
	SS	Enable ◆	1
		Optional function, only available for vibrator model.	
1D Barcode Inverse Reading 	SS	Disable ◆	0
	SS	Enable	1



PROGRAM

Operation Control
(All Series)



F_DEFAULT

Beeping Control, Radio Connection Beeps

Family Code Selection	P.C	Parameter Selection	Option Code
<p>Beeping Control</p>	<p>SS SS SS SS</p>	<p>Radio Connected/ Disconnected Beep On ◆ Radio Connected/ Disconnected Beep Off Battery Power Low Beep On ◆ Battery Power Low Beep Off</p>	<p>0 1 2 3</p>
<p>Radio Connection Beeps</p>	<p>SS SS</p>	<p>Four ascending tone / Four descending tone ◆ Low-high two beeps / High-low two beeps</p>	<p>0 1</p>



PROGRAM

**Operation Control
(A Series & PA Series)**

Buzzer Volume



F_DEFAULT

Family Code Selection	P.C	Parameter Selection	Option Code
Buzzer Volume 	SS SS SS	Low Medium High ◆	0 1 2

- Available firmware:
 - A770BT: 1.00.13 and above; 2.00.03 and above
 - A670BT: 1.00.01 and above
 - Other A and PA Series scanners: All firmware versions



PROGRAM

Operation Control
(A Series & PA Series)
Timestamp Functions



F_DEFAULT

Family Code Selection	P.C	Parameter Selection	Option Code
<p>Set Date</p>	SS	<p>Scan Date (MMDDYY)</p> <p>For example, 2014-12-24, set 122414</p>	6 digits + END
<p>Set Time</p>	SS	<p>Set Time (HHMM)</p> <p>For example, for 24-hour clock Time Conversion, 14:56 set 1456</p>	4 digits + END
<p>Timestamp Format Setting</p>	SS	<p>HH:MM DD/MM/YYYY</p> <p>SS HH:MM MM/DD/YYYY ◆</p> <p>SS HH:MM YYYY/MM/DD</p> <p>SS HH:MM:SS DD/MM/YYYY</p> <p>SS HH:MM:SS MM/DD/YYYY</p> <p>SS HH:MM:SS YYYY/MM/DD</p> <p>SS DD/MM/YYYY HH:MM</p> <p>SS MM/DD/YYYY HH:MM</p> <p>SS YYYY/MM/DD HH:MM</p> <p>SS DD/MM/YYYY HH:MM:SS</p> <p>SS MM/DD/YYYY HH:MM:SS</p> <p>SS YYYY/MM/DD HH:MM:SS</p> <p>SS DD/MM/YYYY</p> <p>SS MM/DD/YYYY</p> <p>SS YYYY/MM/DD</p> <p>SS HH:MM</p> <p>SS HH:MM:SS</p>	<p>0</p> <p>1</p> <p>2</p> <p>3</p> <p>4</p> <p>5</p> <p>6</p> <p>7</p> <p>8</p> <p>9</p> <p>10</p> <p>11</p> <p>12</p> <p>13</p> <p>14</p> <p>15</p> <p>16</p>



PROGRAM

Operation Control
(A Series & PA Series)

Timestamp Functions (continued)



F_DEFAULT

Family Code Selection	P.C	Parameter Selection	Option Code
Date & Time Format Setting 	SS	12 hour	0
	SS	24 hour ◆	1
	SS	Short Year (YY)	2
	SS	Full Year (YYYY) ◆	3
Timestamp Output Control 	SS	None ◆	0
	SS	Batch mode	1
	SS	Online mode	2
	SS	Online mode & Batch mode	3
Stored Data Output Format 	SS	Data/Record ◆	0
	SS	Quantity + Data/Record	1
	SS	Data/Record + Quantity	2
	SS	Timestamp + Data/Record	3
	SS	Data/Record + Timestamp	4
	SS	Timestamp + Quantity + Data/Record	5
	SS	Timestamp + Data/Record + Quantity	6
	SS	Quantity + Timestamp + Data/Record	7
	SS	Quantity + Data/Record + Timestamp	8
	SS	Data/Record + Timestamp + Quantity	9
	SS	Data/Record + Quantity + Timestamp	10
Online Mode Output Format 	SS	Data/Record ◆	0
	SS	Timestamp + Data/Record	1
	SS	Data/Record + Timestamp	2

▪ **Timestamp Function** is available for both **Online Mode** and **Batch Mode**.



PROGRAM

Operation Control
(*PF, PL & PA Series*)



F_DEFAULT

Radio Link Mode for Discoverable Mode

Family Code Selection	P.C	Parameter Selection	Option Code
Radio Link Mode for Discoverable Mode 	SS	HID Mode ◆	0
	SS	HID Mode with Passkey	1
	SS	HID Legacy Mode	2
	SS	SPP Slave Mode	3
		You may also press FN1 of pocket scanner for more than 3 seconds to enter discoverable mode.	



PROGRAM

**Operation Control
(F&L Series)**

Redundancy



F_DEFAULT

Family Code Selection	P.C	Parameter Selection	Option Code
<p>Redundancy</p>	<p>SS SS SS SS SS SS</p>	<p>None Level 1 ◆ Level 2 Level 3 Level 4 Level 5 To prevent potential miss reading.</p>	<p>0 1 2 3 4 5</p>

▪The Redundancy is the number of additional times the same bar code label has to be decoded before it is transmitted.



PROGRAM

Operation Control
(All Series)
Delay Setting



F_DEFAULT

Family Code Selection	P.C	Parameter Selection	Option Code
Reread Delay (Double Scan Verification) 	SS	Disable	0
	SS	Immediate time out ◆	1
	SS	Short time out	2
	SS	Medium time out	3
	SS	Long time out	4
	SS	Force verification	5
Good Read Delay 	SS	None ◆	0
	SS	200 msec.	1
	SS	500 msec.	2
	SS	1 sec.	3
	SS	1.5 sec.	4
	SS	2 sec.	5
HID Mode Transmit Delay 	SS	None ◆	FIN (3 digits)
	MS	1-250 msec.	
		Scan 3 digits from the option code chart in Appendix, then FuzzyScan will terminate this selection automatically.	

- The **Reread Delay (Double Scan Verification)** is designed to inhibit FuzzyScan from reading the same bar code label twice in pre-defined short duration. Force Verification will not allow reading of the same bar code twice.
- This **Good Read Delay** is the minimum amount of time before the scanner can read another bar code.
- This **HID Mode Transmit Delay** will affect HID mode; When the scanner pairs with the Android, set this to 70ms to avoid data loss.



PROGRAM

Operation Control
(All Series)



F_DEFAULT

**Light Source & Hand Free Time-out Setting,
Good Read Duration**

Family Code Selection	P.C	Parameter Selection	Option Code
Light Source On Time 	SS	Short	0
	SS	Medium	1
	SS	Long ◆	2
	SS	Extremely long	3
Hands Free Time-out 	SS	Short ◆	0
	SS	Medium	1
	SS	Long	2
	SS	Extremely long	3
	SS	Disable	4
Good Read Duration 	SS	Short	0
	SS	Medium ◆	1
	SS	Long	2
	SS	Extremely long	3
	SS	Extremely short	4

- The **Light Source On Time** is a pre-defined light source time out counter for Alternative Mode, Presentation Mode and Level Mode. The scanner keeps the light source on till the pre-defined light source on time is up. You can adjust this parameter to meet your own application requirement.
- The Presentation Mode is referred to as “hands free” mode. The hands free mode will be automatically changed to manual trigger mode when you press the trigger. You can remain the scanner in manual trigger mode by setting the Hands Free Time-Out. Once the time-out duration is up (if there’s no any trigger operation), the imager will revert to the original hands free mode.
- Use **Good Read Duration** (Good Read Beep and Vibration Duration) to define beeps and vibration according to operator preference and work environment.





PROGRAM

Operation Control
(All Series)



F_DEFAULT

Low Power Standby Mode Settings

Family Code Selection	P.C	Parameter Selection	Option Code
Time Delay to Low Power Standby Mode 	SS	1 sec	0
	SS	3 secs	1
	SS	5 secs ◆	2
	SS	7 secs	3
	SS	9 secs	4
	SS	Immediate	5
Low Power Standby Mode Link Indication 	SS	Turn off immediately	0
	SS	Last for 1 minute ◆	1
	SS	Keep on till power-off	2

▪The Time Delay to Low Power Standby Mode sets the time for scanner to enter low power trigger mode after any scanning activity.



PROGRAM

Operation Control
(All Series)



F_DEFAULT

Presentation Scanning Setting

Family Code Selection	P.C	Parameter Selection		Option Code	
Presentation Auto-sense 	SS SS	Disable ◆ Enable		0 1	
Presentation Sensitivity 	SS SS SS SS SS	Level 1 Level 2 Level 3 Level 4 Level 5 ◆	Level 6 Level 7	0 1 2 3 4	5 6

- When enable the **Presentation Auto-sense**, the scanner can be switched between hands free scanning and hand-held scanning automatically when working with the SmartStand or cradle.
- The **Presentation Sensitivity** is used to configure the sensitivity level when the scanner is set as presentation mode. The higher lever means higher sensitivity for detecting the barcode.



PROGRAM

Operation Control
(F, L, PF, & PL Series)

Scan Rate Control



F_DEFAULT

Family Code Selection	P.C	Parameter Selection	Option Code
<p>Scan Rate Control</p>	<p>SS SS</p>	<p>Dynamic ◆ Fixed</p>	<p>0 1</p>

- **Scan Rate Control:** The scanner will have better motion tolerance when you select “Fixed” scan rate. It’s suitable for application which needs higher motion tolerance on the move. But this may impact to the reading distance.



PROGRAM

Operation Control
(A, PA Series)
Smart Scene



F_DEFAULT

Family Code Selection	P.C	Parameter Selection	Option Code
Smart Scene 	SS	Scene 1 ◆	0
	SS	Scene 2	1
	SS	Scene 3	2
	SS	Scene 4	3
	SS	Scene 5	4
	SS	Scene 6	5
	SS	Scene 7	6

▪ **Smart Scene** optimizes scanners' motion tolerance, scanning speed and scanning sensitivity in different scanning environment.

- Scene 1: This is the default setting. It optimizes scanners' motion tolerance, scanning speed and scanning sensitivity in most working environment.
- Scene 2: The scanner is optimized for scanning high-density barcode.
- Scene 3: This setting is for general retail application.
- Scene 4: Another setting also optimized for general retail application, as well as the performance when scanning barcodes displayed on the screens of devices, especially those with large screen LCD or with low brightness.
- Scene 5: An application-specific mode optimizes the scanner for scanning low PCS (print contrast) barcodes on circuit board.
- Scene 6: An application-specific mode optimizes the scanner for scanning barcodes on circuit board with the sufficient ambient light.
- Scene 7: An application-specific mode optimizes the scanner for scanning barcodes from the mobile device screens.



PROGRAM

Operation Control
(L & PL Series)



F_DEFAULT

SmartStand Power Off Timeout, Laser Aiming Control, LED Illumination Control & Delay

Family Code Selection	P.C	Parameter Selection	Option Code
SmartStand Power Off Timeout 	SS SS SS	3 mins ◆ 5 mins 10 mins Only available for FuzzyScan L series scanners.	0 1 2
Laser Aiming Control 	SS SS	Disable Enable ◆	0 1
LED Illumination Control 	SS SS	Always on Intelligent Mode ◆	0 1
LED Illumination Delay 	SS SS SS SS SS	100 ms 150 ms ◆ 200 ms 250 ms 300 ms	0 1 2 3 4

- **The SmartStand Power Off Timeout** is a pre-defined duration for scanner's light source on time when the scanner is placed on SmartStand. While the scanner is placed on SmartStand, the scanner will be switched from hand-held scanning to presentation scanning and the light source will be forced on automatically. The light source will be off when the pre-defined duration is up.
- **Laser Aiming Control:** You can disable or enable laser aiming line when you scan **PDF barcode**.
- **LED Illumination Control:** When you enable "always on", the LED illumination will be always on when you press the trigger. When you enable "intelligent mode", the scanner will emit the laser aiming line first, the LED illumination will be turned on after the preset LED illumination delay. Intelligent mode is recommended to be used in regular ambient light environment.



PROGRAM

Operation Control
(A Series & PA Series)



F_DEFAULT

**Illumination Control,
Presentation Background Lighting Control**

Family Code Selection	P.C	Parameter Selection	Option Code
Illumination Control 	SS SS	Disable Enable ◆	0 1
Presentation Background Lighting 	SS SS	LEDs Off LEDs On ◆	0 1

- The **Illumination Control** is only available for hand-held mode.
- **Presentation Background Lighting Control:** You can enable or disable presentation background lighting of the scanner according to the ambient light condition in presentation mode. When the ambient light is dim or dark, you can enable this function to turn on the scanner's LED illumination at a dim level. This is helpful for scanner to detect the motion of scene.



PROGRAM

Operation Control
(A Series & PA Series)



F_DEFAULT

**Aiming Control, Pre Decode Aiming Timer,
Decode Aiming Control**

Family Code Selection	P.C	Parameter Selection		Option Code	
Aiming Control 	SS	Regular Aiming ◆		0	
	SS	Pre-decode Aiming Control		2	
Pre Decode Aiming Timer 	SS	200 ms	1.5 secs.	0	4
	SS	400 ms ◆	2 secs.	1	5
	SS	800 ms	3 secs.	2	6
	SS	1 sec	4 secs.	3	7
Decode Aiming Control 	SS	Disable in Hand-Held mode		0	
	SS	Enable in Hand-Held mode ◆		1	
	SS	Disable in Hand-Free mode		2	
	SS	Enable in Hand-Free mode ◆		3	

- The **Aiming Control** is available for Trigger mode and Multiple Read Mode.
 - Under **Regular Aiming**, the aiming light is turned on only when the trigger button is pressed.
 - **Pre-decode Aiming** provides a time duration for the user to aim the target barcode before the scanner starts to decode. When the user presses and holds the trigger button, the aiming light will be on but the main light source won't until the timer runs out. When the timer runs out, the scanner will turn on its main light source and start to find a barcode to decode. The time duration between the pressed trigger and the start of the scan session can be adjusted by setting **Pre-Decode Aiming Timer**. The Pre-decode Aiming can help the user to avoid a misreading if the user needs to read a specific barcode when there are other barcodes within close range.
- The **Pre-decode Aiming** is only effective under Trigger Mode and Multiple Read Mode.
- Use **Decode Aiming Control** to turn on or turn off the aiming light during the scan session:
 - Under Handheld mode, enable/disable Decode Aiming Control to turn on/off the aiming light when the trigger is pressed.
 - Under Hands-free mode, enable/disable Decode Aiming Control to turn on/off the aiming light when the scanner detects an object and starts a scan session.



PROGRAM

Operation Control
(A Series & PA Series)



F_DEFAULT

Center Alignment, Unique Barcode Reporting

Family Code Selection	P.C	Parameter Selection	Option Code
Center Alignment 	SS	Disable in Hand-Held Mode ◆	0
	SS	Enable in Hand-Held Mode	1
	SS	Disable in Hand-Free Mode ◆	2
	SS	Enable in Hand-free Mode	3
Unique Barcode Reporting 	SS	Disable ◆	0
	SS	Enable	1

- **Center Alignment:** When this function is enabled, the scanner only decodes barcode(s) around aiming line.
- **Unique Barcode Reporting:** When this function is enabled, the scanner will only output data from each barcode once during a scanning cycle (trigger key pressed and held without release). This prevents the output of repeat data in case a barcode is accidentally read multiple times during the same scanning cycle. For **Multiple Read mode** only.



PROGRAM

Operation Control
(All Series)



F_DEFAULT

Out-of-range Scanning

Family Code Selection	P.C	Parameter Selection	Option Code
Out-of-range Scanning 	SS SS	Disable ◆ Enable	0 1

▪ **Out-of-range Scanning** - When radio link is built between the scanner and remote host device, the scanner will transmit each scanned data right after scanning the barcode data. However, the scanner is preset for unable to scan any barcode data when it loses the radio connection. You can enable the Out-of-range Scanning function to continue scanning barcode data into memory buffer until radio link resumed.



PROGRAM

Operation Control
(All Series)



F_DEFAULT

Radio-off Time-out & Power Off Time-out Control

Family Code Selection	P.C	Parameter Selection	Option Code
Radio-off Time-out - Connect State 	SS MS	12 (x5) minutes ◆ 0-99 (x5) minutes If you don't want the scanner to enter power-off, please set time-out to "0"	FIN (2 digits)
Radio-off Time-out - Disconnect State 	SS MS	1 (x1) minute ◆ 0-99 (x1) minutes If you don't want the scanner to enter power-off, please set time-out to "0"	FIN (2 digits)
Power Off Time-out 	SS MS	1 (x5) minutes ◆ 0-99 (x5) minutes If you want the scanner to enter power off mode immediately, please set time-out to "0"	FIN (2 digits)

- The **Radio-off Time-out Control** can be set under radio connection or disconnection state. If the scanner is not used within the preset time-out duration, it will automatically enter "Power Off" for power saving purpose. You are able to disable this function by setting the time-out duration to "0".
- The **Power Off Time-out**: When the scanner is under radio-off, it is preset to enter Power Off automatically if the radio is not on after the time-out duration. If you would like to power on the scanner, please press the trigger button. You can have the scanner enter this function immediately by setting the time-out duration to "0"



PROGRAM

Operation Control
(PF, PL, & PA Series)



F_DEFAULT

FN2 Function Mode Setting

Family Code Selection	P.C	Parameter Selection	Option Code
FN2 Function Mode 	SS SS	Batch Scanning ◆ Validation Scanning	0 1

■The **FN2 Function Mode**: The Batch Scanning (Inventory Mode) is set as the default FN2 function mode. Batch Scanning and Validation Scanning can't be used at the same time. If you want to use Function Key of pocket scanner to carry out Validation Scanning, you have to change the default setting.



PROGRAM

Operation Control
(All Series)
Batch Scanning Setting



F_DEFAULT

Family Code Selection	P.C	Parameter Selection	Option Code
Batch Scanning Link Control 	SS SS	Radio disable Radio enable ◆	0 1
Stored Data Transmission 	SS SS SS	All On cradle Scan barcode ◆	0 1 2
Delete Stored Data after Transmission 	SS SS	Disable ◆ Enable	0 1

- The **Batch Scanning Link Control** is a pre-defined radio option to control the radio-on or radio-off status under batch scanning operation. Please note that if the radio disable is activated, the radio link will be disconnected once you enter batching scanning. The radio link will be resumed when you transmit the stored data or exit batch scanning.
- The **Stored Data Transmission** is a pre-defined approach when you want to transmit the scanned data under batch scanning operation. You can transmit the scanned data by placing the scanner onto the cradle or scanning “Transmit Stored Data” command, or by either one of both methods.
- In batching scanning, the default setting of **Delete Stored Data after Transmission** is disable. The scanner will keep all stored data after transmission until you scan the “Clear All Stored Data” command. You are also able to delete all stored data after transmission automatically by enabling this function.



PROGRAM

Operation Control
(All Series)



F_DEFAULT

Batch Scanning Data Transmission Setting

Family Code Selection	P.C	Parameter Selection	Option Code
Field Delimiter 	SS SS SS SS SS SS	None , ◆ SPACE - . User define	0 1 2 3 4 5, [00-7F]
Stored Data Output Format 	SS SS SS	As many times as the quantity indicates ◆ <Quantity><Field Delimiter><Scanned Data> <Scanned Data><Field Delimiter><Quantity>	0 1 2
Data Transmission Format 	SS SS SS	Disable (scanned data only) ◆ Leading with MAC address (MAC address and scanned data) Leading with ID No. (scanner ID and scanned data) Only available for RS232, USB HID and USB COM interface in PAIR & PICO modes	0 1 2

- The **Field Delimiter** is used to separate the specific information and scanned data into two fields. You can choose desired delimiter format.
- The **Stored Data Output Format** If you want to input the quantity information of barcode data, you can enter the quantity from 1 to 9999 by scanning the quantity barcodes right after you scanned the barcode data. The quantity information will be stored into the memory storage together with the barcode data. There are three ways to output the stored barcode data and quantity information.
- In PICO mode, up to 7 scanners can be connected with one smart cradle. The **Data Transmission Format** can help user to identify the source of the transmitted data. You can choose to transmit the scanned data leading with MAC address or pre-assigned ID.
Example format: <MAC address><Field Delimiter><Data> or <ID><Field Delimiter><Data>.



PROGRAM

Operation Control
(All Series)

Validation Scanning Setting



F_DEFAULT

Family Code Selection	P.C	Parameter Selection	Option Code
Validation Mode Link Control 	SS SS	Radio Disabled Radio Enabled ◆	0 1
Master Data Setting 	SS SS	Single master data ◆ Multiple master data	0 1
Validation Output 	SS SS SS SS SS SS	Disable data transmission ◆ Transmit valid data Transmit invalid data Transmit valid data or "NG" Transmit invalid data or "OK" Transmit "OK" or "NG"	0 1 2 3 4 5 6

- The **Validation Mode Link Control** is a pre-defined radio option to control the radio-on or radio-off status under Validation Scanning operation. Please note that if the radio disable is activated, the radio link will be disconnected once you enter Validation Scanning. The radio link will be resumed when you enable data transmission or exit Validation Scanning.
- The **Master Data Setting**: The default Master Data Setting is preset to "Single Master Data". If Single Master Data is selected, though you can scan multiple master data continuously, only the last master data will be valid, and the master data registered previous to the last master data will be cleared. If the multiple master data is required, you have to change the default setting. The scanner is capable of storing up to 2K bytes master data.
- The **Validation Output (Validation Result Output)** is preset to "Disable data transmission". There are six ways to output the validation result.



PROGRAM

Operation Control
(All Series)



F_DEFAULT

Bluetooth: Device Name & PIN Code Setting

Family Code Selection	P.C	Parameter Selection	Option Code
Bluetooth Device Name 	SS MS	Default device name ◆ User define; F/L series: 1-16 characters A series: 1-32 characters	FIN [00-7F], FIN
Bluetooth PIN Code 	SS MS	Default Bluetooth PIN Code ◆ User define, 1-8 numbers	FIN [30-39], FIN

- The default **Bluetooth Device Name** for **F/L series** is "F(L)xxxBT-xxxx", and for **PF/PL series** is PF(L)xxxBT-xxxx, you will be able to change the device name by scanning HEX values (1-16 characters).
- The default **Bluetooth Device Name** for **A series** is "AxxxBT-xxxx", you will be able to change the device name by scanning HEX values (1-32 characters).
- The default **Bluetooth PIN Code** is "00000000", you will be able to change the PIN Code by scanning HEX values (1-8 numbers).



PROGRAM

Operation Control
(All Series)



F_DEFAULT

Bluetooth: Other Settings

Family Code Selection	P.C	Parameter Selection	Option Code
Bluetooth Sniff Control 	SS SS	Disable ◆ Enable	0 1
Link Quality Control 	SS SS SS SS SS	Disable ◆ Level 1 Level 2 Level 3 Level 4	0 1 2 3 4

- **Bluetooth Sniff Control:** the Bluetooth module will enter low power consumption mode when this function is enabled.
- **Link Quality Control:** This function is only available for SPP and HID mode. When you use the scanner in the boundary of radio signal, you can enable this function to increase the reliability of data transmission. Be aware this function will affect the communication distance: the higher the level is, the shorter the communication distance is.



PROGRAM

Operation Control
(All Series)

On-screen Keyboard Control



F_DEFAULT

Family Code Selection	P.C	Parameter Selection	Option Code
On-screen Keyboard Control 	SS SS	Disable Enable ◆	0 1

- When On-screen Keyboard Control is **enabled**, the scanner is preset to switch between barcode scanning and on-screen keyboard of **most popular devices**; you also can have the scanner entered this setting by scanning “**General Approach**” quick set command. Then you can turn off the radio to activate the on-screen keyboard by scanning “Switch On-screen Keyboard” quick set command. If you use pocket scanner, you can activate the on-screen keyboard toggle by short pressing the **FN1**.
- To work with **iOS device**, please change On-screen Keyboard Control to **disable**, or scan the “**iOS Approach**” quick set command to activate this function. Then you can scan “Switch On-screen Keyboard” quick set command to toggle the iOS on-screen keyboard. If you use pocket scanner, you can also activate the iOS on-screen keyboard toggle by short pressing the **FN1**.
- When you finished the keyboard input, please press the trigger once to turn on the radio, and the on-screen keyboard will be inactivated.



PROGRAM

Condensed DataWizard Preamble, Postamble, Data Length & Symbol ID Transmission



F_DEFAULT

Family Code Selection	P.C	Parameter Selection	Option Code
<p style="text-align: center;">Preamble</p>	SS MS	None ◆ 1-15 characters Maximum 15-character input; scan "FIN" to terminate this selection.	FIN [00-7F], [FIN]
<p style="text-align: center;">Postamble</p>	SS MS	None ◆ 1-15 characters Maximum 15-character input; scan "FIN" to terminate this selection.	FIN [00-7F], [FIN]
<p style="text-align: center;">Data Length Transmission</p>	SS SS	Disable ◆ Enable 2 digits data length transmission If data length exceeds 99, 3-digit data length will be transmitted.	0 1
<p style="text-align: center;">Symbology ID Transmission</p>	SS SS SS SS SS SS SS	Disable symbology ID transmission ◆ Enable prefix symbology ID transmission Enable suffix symbology ID transmission Enable both prefix and suffix symbology ID transmission Enable prefix AIM symbology ID transmission Enable suffix AIM symbology ID transmission Enable both prefix and suffix AIM symbology ID transmission	0 1 2 3 4 5 6

- **DataWizard** is the most powerful, Artificial-Intelligence based data editing expert system provided specially for the FuzzyScan family bar code readers. Through DataWizard, you can process the scanned data prior the transmissions in many ways as **Insert, Delete, Match, Verify, Replace, Reorganize, and Repeat Transmission**. It will help you to arrange the transmission of scanned data to any specific format without software modification.
- Due to the resources concern, **Full-feature DataWizard** is only supported by **PowerTool**. Through the PowerTool, all settings and configurations can be done on-screen on Windows-based operating system.
- A **Condensed Version DataWizard** is provided by each FuzzyScan scanner. Through this menu, the condensed DataWizard can be utilized easily via barcode menu readings.
- Please note that all "**Character**" input should be referred to the **ASCII/HEX Table** listed in Appendix to find matched HEX value.
- If you have any problem to use DataWizard, please refer to following pages for details, as well as consult your local FuzzyScan vendor or our web site for further assistance.



PROGRAM

Condensed DataWizard Data Formatter Setting



F_DEFAULT

Family Code Selection	P.C	Parameter Selection	Option Code	2nd Option Code
Formatter Control 	SS MS MS	Disable ◆ Select one bar code symbology Select all bar code symbologies	FIN (2 digits) 00	automatic termination automatic termination
1st Insertion 	SS DS	Disable ◆ Enable 2-digits identified position; max. 3 insertion characters	FIN (2 digits) position	[1-3 characters], [FIN]
2nd Insertion 	SS DS	Disable ◆ Enable 2-digits identified position; max. 3 insertion characters	FIN (2 digits) position	[1-3 characters], [FIN]
3rd Insertion 	SS DS	Disable ◆ Enable 2-digits identified position; max. 3 insertion characters	FIN (2 digits) position	[1-3 characters], [FIN]
4th Insertion 	SS DS	Disable ◆ Enable 2-digits identified position; max. 3 insertion characters	FIN (2 digits) position	[1-3 characters], [FIN]

- The **Data Formatter** is used to edit the scanned raw data prior to transmitting the data to the host computers or terminals. It allows you to select desired bar code symbologies for formatter control, and provides **Multiple Position Insertion** and **Multiple Character Insertion** (max three characters) in the identified position.
- While the Data Formatter is enabled, it arranges only scanned data without **Preamble**, **Postamble**, **STX**, **ETX**, **Data Length**, **Prefix/Suffix Symbology ID** or **Record Suffix**. All of the above programmable parameters perform the same function depending on your setting.
- Regarding the “**Bar Code Selection**” and “**Position Calculation**” of data formatter, please refer to page 127 for details.
- Please note that all “**Character**” input should be referred to the **ASCII/HEX Table** listed in Appendix to find matched HEX value.



PROGRAM

Condensed DataWizard Data Verifier Setting



F_DEFAULT

Family Code Selection	P.C	Parameter Selection	Option Code	2nd Option Code
Verifier Control 	SS MS MS	Disable ◆ Select one bar code symbology Select all bar code symbologies	FIN (2 digits) 00	automatic termination automatic termination
Identified Data Length 	SS MS	Disable ◆ Enable Determine the identified data length for verification.	FIN (2 digits)	
1st Identified Character 	SS DS	Disable ◆ Enable 2-digits checking position; 1 identified character	FIN (2 digits) position	[00-7F]
2nd Identified Character 	SS DS	Disable ◆ Enable 2-digits checking position; 1 identified character	FIN (2 digits) position	[00-7F]
3rd Identified Character 	SS DS	Disable ◆ Enable 2-digits checking position; 1 identified character	FIN (2 digits) position	[00-7F]

- The **Data Verifier** is used to provide advanced verification for error-free scanning and to work as an **Embedded Data Transmitting Filter**.
- All data must conform to the **Identified Bar Code Symbologies**, **Identified Data Length**, and one to three **Identified Characters** in the checking position. Otherwise, the FuzzyScan will not transmit the data to the host computers or terminals, but will instead issue **3 long beeps** for verification error and **skip** the scanned data.
- The Data Verifier checks only scanned data without **Preamble**, **Postamble**, **STX**, **ETX**, **Data Length**, **Prefix/Suffix Symbology ID** or **Record Suffix**.
- Regarding the “**Bar Code Selection**” and “**Position Calculation**” of **Data Verifier**, please refer to page 127 for details.
- Please note that all “**Character**” input should be referred to the **ASCII/HEX Table** listed in Appendix to find matched HEX value.



PROGRAM

Condensed DataWizard Data Replacer Setting



F_DEFAULT

Family Code Selection	P.C	Parameter Selection	Option Code	2nd Option Code
Replacer Control 	SS MS MS	Disable ◆ Select one bar code symbology Select all bar code symbologies	FIN (2 digits) 00	automatic termination automatic termination
1st Replacement 	SS DS	Disable ◆ Enable 2-digits identified position; 1 replacement character	FIN (2 digits) position	[00-7F]
2nd Replacement 	SS DS	Disable ◆ Enable 2-digits identified position; 1 replacement character	FIN (2 digits) position	[00-7F]
3rd Replacement 	SS DS	Disable ◆ Enable 2-digits identified position; 1 replacement character	FIN (2 digits) position	[00-7F]

- The **Data Replacer** is used to edit the scanned raw data prior to transmitting the data to the host computers or terminals. It allows you to select desired bar code symbologies for replacer control, and provides **Multiple Position Replacement** in the identified position.
- All data must conform to the **Identified Bar Code Symbologies**, and one to three **Identified Characters** in the identified position while the Data Replacer is enabled, it arranges only scanned data without **Preamble**, **Postamble**, **STX**, **ETX**, **Data Length**, **Prefix/Suffix Symbology ID** or **Record Suffix**.
- Regarding the “**Bar Code Selection**” and “**Position Calculation**” of Data Replacer, please refer to page 127 for details.
- Please note that all “**Character**” input should be referred to the **ASCII/HEX Table** listed in Appendix to find matched HEX value.



PROGRAM

Condensed DataWizard Data Organizer Setting



F_DEFAULT

Family Code Selection	P.C	Parameter Selection	Option Code	2nd Option Code
Organizer Control 	SS MS MS	Disable ◆ Select one bar code symbology Select all bar code symbologies	FIN (2 digits) 00	automatic termination automatic termination
1st Organization 	SS DS	Disable ◆ Enable 2-digits identified position; Forward/backward data transmission setting	FIN (2 digits) position direction	0 (Forward) ◆ 1 (Backward)
2nd Organization 	SS DS	Disable ◆ Enable 2-digits identified position; Forward/backward data transmission setting	FIN (2 digits) position direction	0 (Forward) ◆ 1 (Backward)
Include/Exclude Control 	SS DS	Transmitted data excluded the data of identified position ◆ Transmitted data included the data of identified position	0 1	

- The **Data Organizer** is used to edit the scanned raw data prior to transmitting the data to the host computers or terminals. It allows you to select desired bar code symbologies for organizer control, and provides maximum two identified positions to send the data **forward** or **backward**. It also allows you to control the transmitted data **including** or **excluding** the data of identification position. Please refer to the application example listed in page 127 for details.
- While the Data Organizer is enabled, it arranges only scanned data without **Preamble**, **Postamble**, **STX**, **ETX**, **Data Length**, **Prefix/Suffix Symbology ID** or **Record Suffix**.
- Regarding the “**Bar Code Selection**” and “**Position Calculation**” of Data Organizer, please refer to page 60 for details.
- Please note that all “**Character**” input should be referred to the **ASCII/HEX Table**.

Select a Barcode Symbology

You can select one or all types of barcode symbologies to use Condensed DataWizard for advanced transmission arrangement. If you scan "00" to select all types, the FuzzyScan will arrange all incoming data to meet your pre-defined format. If you want to select only one type bar code, please select one of the option code listed below.

1D Bar Code Symbology			
Code 128	01	Matrix 2 of 5	38
GS1-128	31	Interleaved 2 of 5	48
UPC-A	02	China Postal Code	58
UPC-A with 2 supplement	32	German Postal Code	68
UPC-A with 5 supplement	42	Standard/Industrial 2 of 5	08
UPC-E	03	Code 93	09
UPC-E with 2 supplement	33	Code 11	10
UPC-E with 5 supplement	43	MSI/Plessey	11
EAN-13	04	UK/Plessey	12
EAN-13 with 2 supplement	34	Telepen	13
EAN-13 with 5 supplement	44	GS1 DataBar	14
EAN-8	05	IATA	15
EAN-8 with 2 supplement	35	Coupon Code	16
EAN-8 with 5 supplement	45	PDF417	17
Codabar/NW-7	06	Codablock F	18
Code 39	07	Code 16K	19
Code 32	37	Code 49	20
Trioptic Code 39	47	GS1 DataBar Limited	22
		GS1 DataBar Expanded	23
		Composite Codes	24
		Micro PDF417	25

2D Bar Code Symbology			
QR Code	A0	MaxiCode	A2
MicroQR Code	A0	Aztec Code	A3
DataMatrix	A1	Chinese Sensible Code	A4
GS1 DataMatrix	A5		

Postal Code			
Korea Post Code	21	Japanese Post	B4
Australian Post	B0	KIX Post	B5
British Post	B1	Planet Code	B6
Intelligent Mail barcode	B3	Postnet	B8

Position Calculation

[Data Formatter]

If there is a 5-character input data string, refer to the following to calculate the actual position for insertion:

	X		X		X		X		X	
00		01		02		03		04		05

[Data Verifier, Data Replacer, Data Organizer]

If there is a 11-character data string, please refer to the following to calculate the actual position for identification.

X	X	X	X	X	X	X	X	X	X	X
00	01	02	03	04	05	06	07	08	09	10

Application Example

If your bar code label is a 16-digit Interleaved 2 of 5 which includes the information of 6-digit date code, 6-digit serial number and 4-digit unit price, you want the FuzzyScan do the following for you without software modification:

- Apply only Interleaved 2 of 5 to the condensed DataWizard.
- Check bar code is actually with 16-digit length.
- Allow bar code output whose date code is leading with “9”.
- Three outputs with “TAB” suffix.
- The date code output should skip “9” and replaced it by “A”.
- The serial number output should be led with “SN”.
- The unit price output should be skipped the first 2 digits.
- Test Bar Code : 9 8 1 0 2 5 1 2 3 4 5 6 9 8 7 6

Actual Output : A81025[TAB]SN123456[TAB]76[TAB]

Programming Procedure

[Data Verifier]

- Scan “Program” to enter the programming mode.
- Scan “Verifier Control” and set bar code symbology to “48” (Interleaved 2 of 5).
- Scan “Identified Data Length” and set the length to “16”.
- Scan “1st Identified Character” and set the identified position to “00”, then set the identified character to “39” (Hex Code of 9).

[Data Formatter]

- Scan “Formatter Control” and set bar code symbology to “48”.
- Scan “1st Insertion” and set the identified position to “06”, then inserted characters to “09” (Hex Code of TAB), “53” (Hex Code of S), “4E” (Hex Code of N).
- Scan “2nd Insertion” and set the identified position to “12”, then inserted character to “09”. In the final, you must scan “FIN” (Finish) code to terminate this selection.
- Scan “3rd Insertion” and set the identified position to “16”, then inserted character to “09”. In the final, you must scan “FIN” (Finish) code to terminate this selection.

[Data Replacer]

- Scan “Replacer Control” and set bar code symbology to “48”.
- Scan “1st Replacement” and set the identified position to “00”, then replaced character to “41” (Hex Code of A).

[Data Organizer]

- Scan “Organizer Control” and set bar code symbology to “48”.
- Scan “1st Organization” and set the identified position to “16”, then set the data transmission to “0” (forward).
- Scan “2nd Organization” and set the identified position to “17”, then set the data transmission to “1” (backward).
- Scan “END” (Exit) to terminate the programming.

[Important Notice]

Please note that Condensed DataWizard will follow the preset working flow as below:

Verifier ▶ **Formatter** ▶ **Replacer** ▶ **Organizer**

So when you set the identified position in Data Organizer, you must consider the inserted data which you already set via Data Formatter.

APPENDIX

Symbology ID Table

Each AIM Code Identifier contains the three-character string **]cm** where:

] = Flag Character, **c** = Code Character, **m** = Modifier Character

1D Symbology ID Table												
Code Family	Primary Format	Cino ID		AIM ID		Code Family	Primary Format	Cino ID		AIM ID		
		Hex value	Char.	Code Char.	Modified Char.			Hex value	Char.	Code Char.	Modified Char.	
UPC	UPC-A	2	A	E	0	EAN/JAN	EAN/JAN-8	05	N	E	4	
	UPC-A with 2 suppl.	32			1		EAN/JAN-8 with 2 suppl.	35			1	
	UPC-A with 5 suppl.	42			2		EAN/JAN-8 with 5 suppl.	45			2	
	UPC-E	3	E		0		EAN/JAN-13	04	F	E	0	
	UPC-E with 2 suppl.	33			1		EAN/JAN-13 with 2 suppl.	34			1	
	UPC-E with 5 suppl.	43			2		EAN/JAN-13 with 5 suppl.	44			2	
	Example: A UPC-A bar code 012345678950 with 2 supplement 12 is transmitted as]E0012345678950]E112						Example: A EAN/JAN-8 bar code 49123562 with 5 supplement 12345 is transmitted as]E449123562]E212345					
Code 128	Code 128	01	B	C	m	Code 93	Code 93	09	H	G	m	
	GS1-128	31	C		1	Code 11	Code 11	10	P	H	m	
Codabar	Codabar/NW-7	06	D	F	m	MSI/Plessey	MSI/Plessey	11	R	M	m	
Code 25	Standard/Industrial 2 of 5	08	I	S	0	UK/Plessey	UK/Plessey	12	S	P	0	
	Matrix 2 of 5	38	K	X	0	Telepen	Telepen	13	T	B	m	
	Interleaved 2 of 5	48	J	I	m	GS1 DataBar	GS1 Databar	14	X	e	m	
							GS1 DataBar Limited	22				
							GS1 DataBar Expanded	23				
	China Postal Code	58	L	X	0	Composite	Composite Code	24				
German Postal Code	68	M	I	m	Code 39	Code 39	07	G	A	m		
						Code 39 Trioptic	47	W	X	0		
IATA	IATA	15	O	R	m	Code 32	37	G	A	0		
UCC Coupon	UCC Coupon Code	Z				PDF417	PDF417	17	V	L	m	
						Micro PDF417	25					
	Example : A UPC-A 512345678900 + GS1-128 81010123451297 bar code is transmitted as]E0512345678900]C181010123451297 Example: A EAN-13 9923456789019 + GS1-128 81010123451297 bar code is transmitted as]E09923456789019]C181010123451297						Codablock	Codablock F	18	Y	O	m
							Korea Post	Korea Post Code	21	a	X	0
Remark: Above examples are given for the transmission of AIM ID.												

2D Symbology ID Table											
Code Family	Primary Format	Cino ID		AIM ID		Code Family	Primary Format	Cino ID		AIM ID	
		Hex Value	Char.	Code Char.	Modified Char.			Hex Value	Char.	Code Char.	Modified Char.
QR Code	QR Code	A0	b	Q	m	British Post	British Post	B1	h	X	0
Micro QR Code	Micro QR Code					Intelligent Mail barcode	Intelligent Mail barcode	B3	j		0
Data Matrix	Data Matrix	A1	c	d	m	Japanese Post	Japanese Post	B4	k		0
	GS1 Data Matrix	A5									0
MaxiCode	MaxiCode	A2	d	U	m	KIX Post	KIX Post	B5	l		0
Aztec Code	Aztec Code	A3	e	z	m	Planet Code	Planet Code	B6	m		0
Chinese Sensible	Chinese Sensible	A4	f	X	0	Postnet	Postnet	B8	o	0	
Australian Post	Australian Post	B0	g		0						

Keyboard Function Code Table

No.	ANSI	ASCII	Key Function 1	Key Function 2	Key Function 3
00	NUL	00H	RESERVED	Ctrl + @	CTRL MAKE (Left)
01	SOH	01H	CTRL (Left)	Ctrl + A	CTRL BREAK (Left)
02	STX	02H	ALT (Left)	Ctrl + B	ALT MAKE (Left)
03	ETX	03H	SHIFT	Ctrl + C	ALT BREAK (Left)
04	EOT	04H	CAPS LOCK	Ctrl + D	CAPS LOCK
05	ENQ	05H	NUM LOCK	Ctrl + E	NUM LOCK
06	ACK	06H	ESC	Ctrl + F	ESC
07	BEL	07H	F1	Ctrl + G	F1
08	BS	08H	BACK SPACE	Ctrl + H	BACK SPACE
09	HT	09H	TAB	Ctrl + I	TAB
10	LF	0AH	F2	Ctrl + J	F2
11	VT	0BH	F3	Ctrl + K	F3
12	FF	0CH	F4	Ctrl + L	F4
13	CR	0DH	ENTER (CR)	Ctrl + M	ENTER (CR)
14	SO	0EH	F5	Ctrl + N	F5
15	SI	0FH	F6	Ctrl + O	F6
16	DLE	10H	F7	Ctrl + P	F7
17	DC1	11H	F8	Ctrl + Q	F8
18	DC2	12H	F9	Ctrl + R	F9
19	DC3	13H	F10	Ctrl + S	F10

No.	ANSI	ASCII	Key Function 1	Key Function 2	Key Function 3
20	DC4	14H	F11	Ctrl + T	WIN MAKE (Left)
21	NAK	15H	F12	Ctrl + U	WIN BREAK (Left)
22	SYN	16H	INS (Insert) (Edit)	Ctrl + V	SHIFT MAKE (Left)
23	ETB	17H	DEL (Delete) (Edit)	Ctrl + W	SHIFT BREAK (Left)
24	CAN	18H	HOME (Edit)	Ctrl + X	HOME (Edit)
25	EM	19H	END (Edit)	Ctrl + Y	END (Edit)
26	SUB	1AH	PAGE UP (Edit)	Ctrl + Z	PAGE UP (Edit)
27	ESC	1BH	PAGE DOWN (Edit)	Ctrl + [PAGE DOWN (Edit)
28	FS	1CH	UP (Edit)	Ctrl + \	UP (Edit)
29	GS	1DH	DOWN (Edit)	Ctrl +]	DOWN (Edit)
30	RS	1EH	LEFT (Edit)	Ctrl + 6	LEFT (Edit)
31	US	1FH	RIGHT (Edit)	*see below note	RIGHT (Edit)

 To emulate the keyboard function key input for user definable parameters, user must configure actual content using the **Reserved ASCII 0 – 31** characters, and also **Enable** the “Function Key Emulation”. Otherwise, the Ctrl output will be done by the scanner. Please refer to the above Keyboard Function Code Table which is for IBM PC/XT/AT, PS/2, PS/VP, COMPAQ PC, HP Vectra PC, Notebook PC, APPLE and PowerMac, and WYSE PC Enhanced or fully compatible machines.

 The last character in the Ctrl Output column is varied for different countries.

Country (refer to Keyboard Layout) & Character					
United State	-	Switzerland	-	France	=
Belgium	-	UK	-	Germany	-
Sweden	-	Denmark	-	Norway	-
Spain	-	Italy	-		

Code Page - Table of Corresponding Languages

Description	Code Page	Description	Code Page
Albanian	850	Hungarian	852
Arabic	1256	Icelandic	850
Arabic	720	Italian	850
Baltic	1257	Japanese	932
Bulgarian	866	Korean	949
Catalan	850	Latin 1	1252
Croatian	852	Latin 2	1250
Cyrillic	1251	Latin 5	1254
Czech	852	Latin American	850
Danish	850	Latvian	775
Dutch	850	Lithuanian	775
Estonian	775	Norwegian	850
English - United Kingdom	850	Polish	852
English - Australia	850	Portuguese	850
English - Canada	850	Romanian	852
English - New Zealand	850	Russian	866
English - United States	437	Serbian	855
English - South Africa	437	Slovakian	852
English - Philippines	437	Slovenian	852
Finnish	850	Spanish	850
French	850	Swedish	850
German	850	Chinese (Tradition)	950
Greece	737	Chinese (Simple)	936
Greece	1253	Thai	874
Hebrew - write	1255	Turkish	857
Hebrew Israel	862	Vietnamese	1258

Code Page - Unicode Hex Input Setup

1. Windows - Setting up the Windows Registry

Step 1: Open the Registry Editor. You can do so by typing “regedit” in the “Search Windows” function or in Command Prompt.

Step 2: Go to HKEY_CURRENT_USER\Control Panel\Input Method

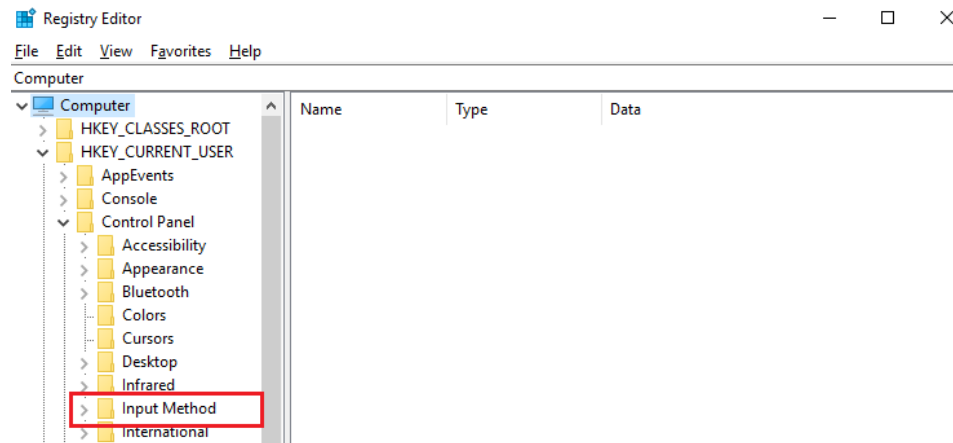

Step 3: Right-click on mouse or press shift + F10 (on keyboard) to add a new String Value (of type “REG_SZ”).

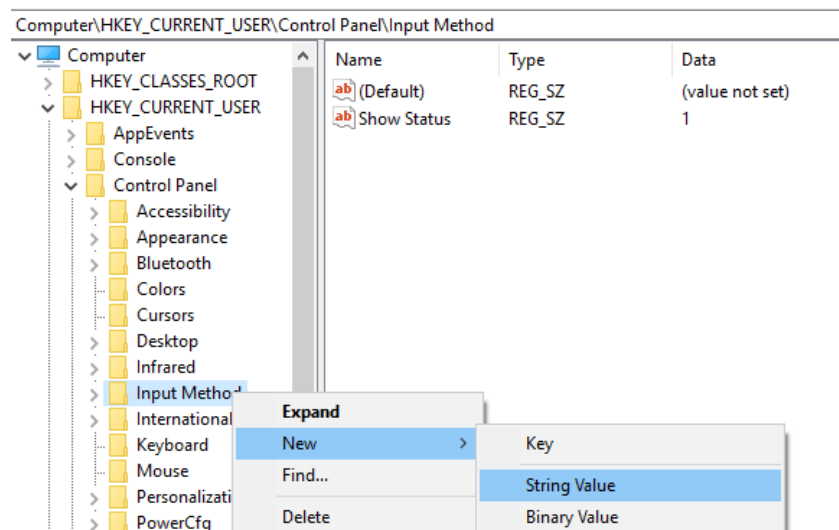

Step 4: Name the new String value as “EnableHexNumpad” and set its Value data to “1”.

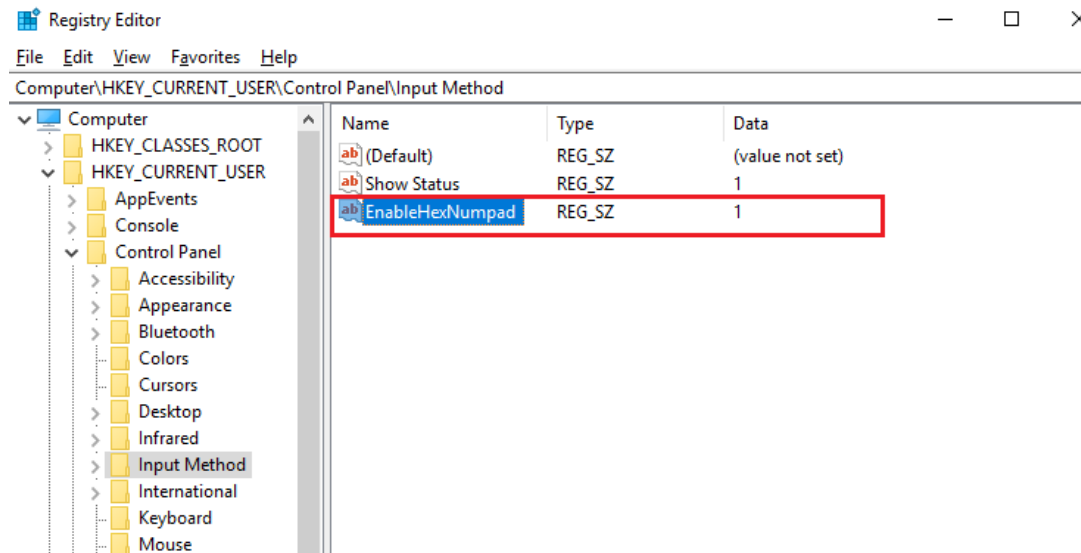

Step 5: Reboot the computer.

2. MAC - Adding Unicode Hex Input in menu bar

Step 1: Go to the Apple Menu -> System Preferences -> Keyboard



Step 2: On the Keyboard tab, click on “Input Sources” and check the “Show Input menu in menu bar” box.

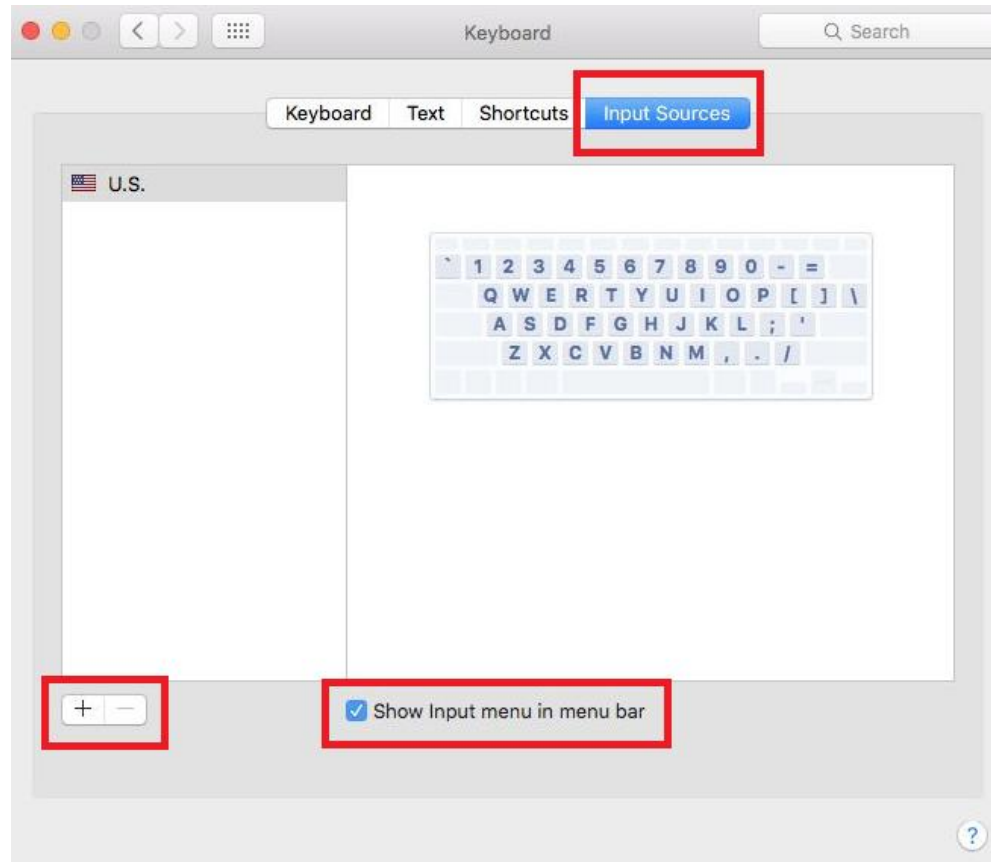

Step 3: Click the “+” button to add an input source.

Step 4: Scroll to and select “Others”. Click on “Unicode Hex Input” (you can also use the Search function to find it). When done, click on the “Add” button.

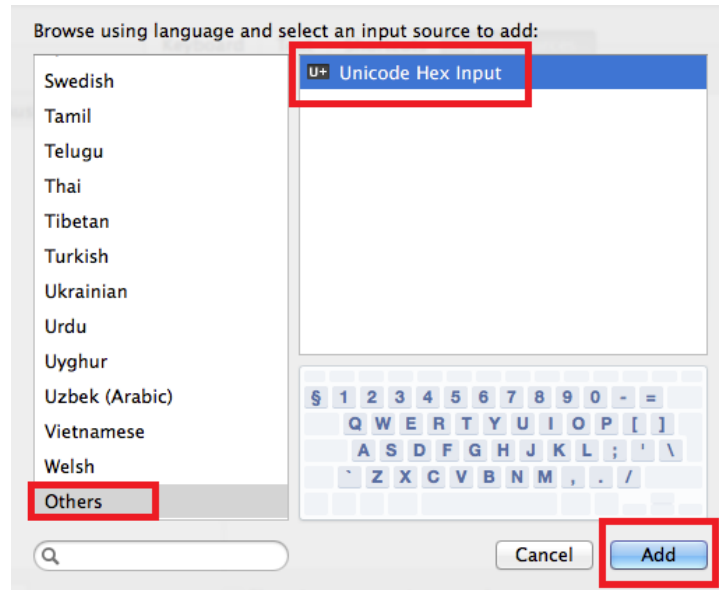

Step 5: Close the Keyboard Preferences menu.

Step 6: Change the input selection to Unicode Hex Input in menu bar.

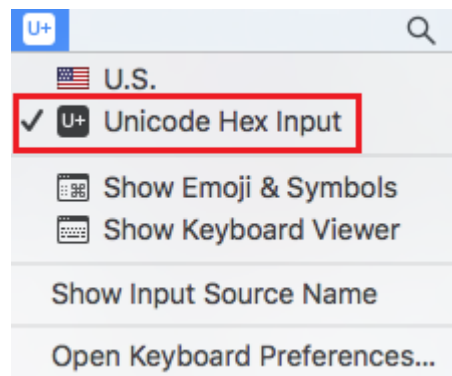

ASCII Input Shortcut

To configure the user definable parameters of FuzzyScan via programming menu, FuzzyScan will ask you to scan your desired ASCII value in **HEX** form. You have to refer to the “**HEX/ASCII Table**” for details.

Example:

If you want the scanned data output leading with a Dollar Sign, you have to set the “Preamble” to “\$”. The configuration procedure is listed below for reference.

- Scan the system command – **PROGRAM** listed on page 3-24 to enter programming mode.
- Scan family code – **PREAMBLE** to select this family.
- Refer to the **Hex/ASCII Table**, you will find the HEX value of “\$” is **24**.
- Scan the option code – **2** listed on the fold out back cover.
- Scan the option code – **4** listed on the fold out back cover.
- Scan the system command – **FIN (Finish)** to terminate Preamble setting.
- Scan the system command – **End** to exit the programming mode for normal operation.

HEX/ASCII Reference Table

H L	0	1	2	3	4	5	6	7
0	NUL	DLE	SPACE	0	@	P	`	p
1	SOH	DC1	!	1	A	Q	a	q
2	STX	DC2	"	2	B	R	b	r
3	ETX	DC3	#	3	C	S	c	s
4	EOT	DC4	\$	4	D	T	d	t
5	ENQ	NAK	%	5	E	U	e	u
6	ACK	SYN	&	6	F	V	f	v
7	BEL	ETB	'	7	G	W	g	w
8	BS	CAN	(8	H	X	h	x
9	HT	EM)	9	I	Y	i	y
A	LF	SUB	*	:	J	Z	j	z
B	VT	ESC	+	;	K	[k	{
C	FF	FS	,	<	L	\	l	
D	CR	GS	-	=	M]	m	}
E	SO	RS	.	>	N	^	n	~
F	SI	US	/	?	O	_	o	DEL

 Example: ASCII “A” → HEX “41”; ASCII “a” → “61”

 : High Byte of HEX Value

 : Low Byte of HEX Value

Link Mode Quick Set Commands



PAIR Mode



Uninstall



PICO Mode



SPP Master Simple Mode



SPP Slave Simple Mode



HID Legacy Mode



HID Mode



HID Mode with Passkey

Host Interface Quick Set Commands

(With Smart Cradle only)



USB HID Standard Mode ◆



USB HID Turbo Mode



USB HID Legacy Mode



RS232 Serial



USB Com Port Emulation



PS/2 (DOS/V) KBW Standard Mode



PS/2 (DOS/V) KBW Turbo Mode



PS/2 (DOS/V) Keyboard Replacement

Option Codes



0



1



2



3



4



5



6

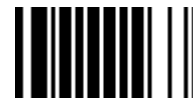

7



8



9



A



B



C



D



E



F



FIN (Finish)



Abort



END (Exit)

System Commands



PROGRAM
(Enter Programming Mode)



FIN (Finish)



END
(Exit Programming Mode)



System Information List
(SYSLIST)



Paging



PowerTool Host Link



Power Off



Save Configuration



Clone



Factory Default



Master Default



- **Factory Default:** After scanning "Factory Default" command, all parameters will be returned to factory default value (The radio link will be disconnected and the scanner will revert to uninstall state).
- **Master Default:** After scanning "Master Default" command, the scanner will remain the pre-set parameters of **Host Interface Selection**, **Keyboard Interface Control** (except Record Suffix; Preamble; Postamble), **Serial Interface Control** (except Record Suffix; Preamble; Postamble), **Wand/Laser Emulation Control**, **Bluetooth Device Name**, **Bluetooth PIN Code**, and **Out-of-range Scanning**, the rest of parameters will be returned to default value (The radio link is still keep on).



Save User Default



User Default

- **User Default:** After scanning "Save User Default" command, all current parameters will be stored to the flash memory. Once you change the parameter and would like to return to previous setting, please scan "User Default".

Indications

Scanner Indication

Items	Link Indicator	Beeping
Radio connection	1 blue blink per 2.5 sec.	Off
Radio disconnection	3 blue blinks per 2 sec.	Off
During connection	Quick blue blinks	Short clicks
Radio connection built	1 blue blink per 2.5 sec.	4 beeps in ascending tone
Radio connection lost	3 blue blinks per 2 sec.	4 beeps in descending tone
Data Transmission	Quick blue blink	Short clicks
Items	Status Indicator	Beeping
Under charging (on cradle)	Steady red	Off
Fully charged (on cradle)	Steady green	Off
Under batch scanning	1 green blink per 2.5 sec.	Off
Pair failure	3 blue blinks per 2 sec.	Off
Out of memory	2 red blinks	2 long beeps
Battery power low	1 red blink at regular interval	1 beep at regular interval
Battery power extremely low	1 red blink	8 beeps
Good read	1 green blink	1 good read beep
Under Configuration	Steady red	Off
Uninstall state	Alternative red and green blinks	Off
Upgrade state	Steady red	Short click
Time out warning	Off	3 long beeps
Paged by smart cradle	Off	6 page beeps
Battery no power	Off	Off
Power Off	Off	Off

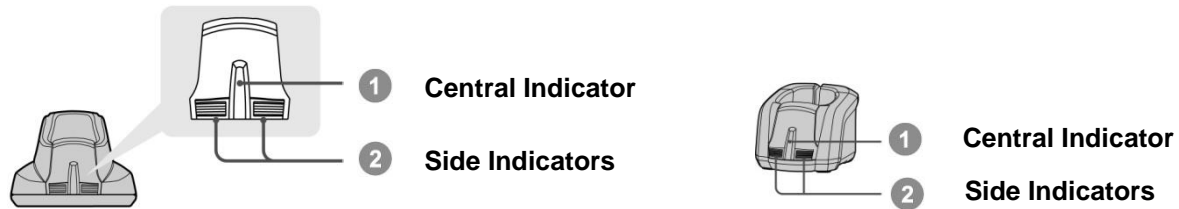

HB2112 / HB3112 Smart Cradle Indications

Items		Indicators		Beeping
		Central	Side	
Power on		Blink blue once	Off	Power on beeps
Smart Cradle Upgrade State		Off	Steady red	Short clicks
Uninstall state		Off	Alternative red-green blinks	Off
PICO Mode	Radio Connected	Steady blue	Steady green	Off
	Radio Disconnected	Off	Steady red	Off
PAIR Mode	Radio Connected	Steady blue	Off	Off
	Radio Disconnected	Off	Steady red	Off
Smart cradle paged by scanner	PICO Mode	Steady blue	Steady green	6 page beeps
	PAIR Mode	Steady blue	Off	6 page beeps

HB2100 Charging Cradle Indication

Items	Central Indicator	Beeping
Power on	Steady blue	Off

SD112 Smart Dongle Indications

Event		Power/Pairing Indicator	Status Indicator
Power on		blue blink once	Off
Dongle Upgrading		Off	Steady red
Unpaired		Off	Alternative red-green blinks
PICO Mode	Radio Connected	Steady blue	Steady Green
	Radio Disconnected	Off	Steady red
PAIR Mode	Radio Connected	Steady blue	Off
	Radio Disconnected	Off	Steady red

FuzzyScan Bluetooth Scanner Programming Manual

CINO GROUP PC WORTH INT'L CO., LTD. www.cino.com.tw