

PEX1001 Series

■ Thermal Transfer ■ Direct Thermal
Industrial Barcode Printers



Series Lists:

PEX1121/ PEX1131/ PEX1161

PEX1221/ PEX1231/ PEX1261

User Manual

Copyright Information

©2021 TSC Auto ID Technology Co., Ltd.

The copyright in this manual, the software and firmware in the printer described are owned by TSC Auto ID Technology Co., Ltd. All rights reserved.

CG Triumvirate is a trademark of Agfa Corporation. CG Triumvirate Bold Condensed font is under license from the Monotype Corporation. Windows is a registered trademark of Microsoft Corporation.

All other trademarks are the property of their respective owners. Information in this document is subject to change without notice and does not represent a commitment on the part of TSC Auto ID Technology Co. No part of this manual may be reproduced or transmitted in any form or by any means, for any purpose other than the purchaser's personal use, without the expressed written permission of TSC Auto ID Technology Co.



Table of Contents

1. Introduction	1
1.1 Product Specification	2
2. Operation Overview	5
2.1 Unpacking and Inspection	5
2.2 Print Engine Orientation	6
2.3 Checking the Installation Space	7
2.4 Printer Overview	11
2.4.1 Front View	11
2.4.2 Interior View	12
2.4.3 Rear View	13
2.5 Operator Control	14
2.5.1 LED Indication and Keypads	14
3. Setup	17
3.1 Setting up the printer	17
3.2 Loading the Ribbon	18
3.3 Loading the Media	22
3.4 Loading Media in Peel-off Mode (Option)	26
4. Knob Adjustment	30

4.1 Ribbon Tension Adjustment Knob.....	31
4.2 Mechanism Fine Adjustment to Avoid Ribbon Wrinkles.....	32
4.3 Suggestion of Ribbon Tension Adjustment	35
5. TSC Console.....	37
5.1 Start TSC Console.....	37
5.2 Setup Ethernet Interface	39
5.3 Set WiFi and Add to TSC Console Interface	41
5.4 Initialize the Printer WiFi Setting	44
5.5 TPH Care.....	45
5.6 Printer Function	46
5.7 Setting Post-Print Action	47
6. LCD Menu Function.....	48
6.1 Enter the Menu	48
6.2 Menu Overview.....	49
6.3 Setting	50
6.3.1 TSPL.....	51
6.3.2 ZPL2	53
6.3.1 SBPL (Only available on EZS version firmware).....	56
6.4 Sensor	57
6.5 Interface.....	58



6.5.1 Serial Comm.....	59
6.5.2 Ethernet.....	60
6.5.3 Wi-Fi.....	61
6.5.4 Bluetooth.....	62
6.5.5 GPIO.....	63
6.5.6 GPIO-DB25 (Only available on EZS Version firmware).....	68
6.6 Advanced.....	72
6.7 File Manager.....	74
6.8 Diagnostic.....	75
6.9 Favorites.....	76
7. TroubleShooting.....	78
8. Maintenance.....	81
9. Agency Compliance and Approvals.....	83
10. Revise History.....	89

1. Introduction

Thank you very much for purchasing TSC bar code printer.

TSC's innovative PEX-1001 Series print engine incorporates a robust die cast construction designed for years of reliability, ease of use, and cost-conscious serviceability. The PEX combines a precision print mechanism with high performance electronics to produce labels at up to 18 inches per second, the fastest in its class.

Designed for ease of integration, the PEX features a bolt-compatible construction with a commonly used GPIO interface and an easy to use color display. The PEX offers simple integration into both new and existing label application installations. It is ideal for manufacturing and logistic applications where high speed and high demand label printing is required.

This document provides an easy reference for operating the PEX-1001 series. TSC printers include the Windows labeling software for creating your label template. For system integration, the TSPL/TSPL2 printer programming manual or SDKs can be found on TSC website : <https://www.tscprinters.com>.

Applications

- Work In Process
- Product Marking
- Compliance Labeling
- Industrial-Duty Printing
- Packing
- Order Fulfillment
- Shipping/Receiving
- Inventory Management Retail
- Product Label
- Event Ticketing

1.1 Product Specification

Item	Printer Model	PEX-1121/PEX-1221	PEX-1131/PEX-1231	PEX-1161/PEX-1261
Resolution		8 dots/mm (203 DPI)	12 dots/mm (300 DPI)	24 dots/mm (600 DPI)
Printing method		Thermal transfer and direct thermal		
Print speed		457mm (18")/second	356 mm (14")/second	152 mm (6")/second
Max. print width		104 mm(4.09")		
Max. print length		25,400 mm (1000")	11,430 mm (450")	2540 mm (100")
Enclosure		Die-cast based print mechanism		
Physical dimension		245 mm (W) x 300 mm (H) x 390 mm (D) 9.65" (W) x 11.81" (H) x 15.35" (D)		
Weight		13 kg (28.66 lbs)		
Ribbon		600 m long, max. O.D. 90 mm, 1" core (ink coated outside or inside)		
Ribbon width		25.4 mm ~ 114.3 mm (1" ~ 4.5")		
Processor		32-bit RISC CPU		
Memory		<ul style="list-style-type: none"> ■ 512MB Flash memory ■ 512MB DDR2 ■ USB device memory (FAT32) ■ Micro SD card reader for memory expansion, up to 32GB 		
Interface		<ul style="list-style-type: none"> ■ RS-232 ■ USB 2.0 ■ Internal Ethernet, 10/100 Mbps ■ USB host * 1 (front side), connecting USB storage device ■ GPIO (DB15F) + Centronics 		

	<ul style="list-style-type: none"> ■ GPIO (DB25F) (dealer option) ■ 802.11 a/b/g/n/ac Wi-Fi + BT wireless (dealer option)
Power	<p>Auto sensing power supply (20% print ratio)</p> <ul style="list-style-type: none"> ■ Input: AC 100-240V, 4-2A, 50-60Hz ■ Output: Total 243W
LCD display/ Operation buttons	<ul style="list-style-type: none"> ■ 3.5" color TFT display, 320 x 240 pixel ■ 1 status indicator
Operation switch, button	<ul style="list-style-type: none"> ■ 6 buttons (Menu, Pause/Feed, Up, Down, Left, Right)
Sensors	<ul style="list-style-type: none"> ■ Gap transmissive sensor (Position adjustable, 15mm ~ 98mm) ■ Black mark reflective sensor ■ Ribbon encoder sensor ■ Head open sensor ■ Media cover open sensor
Real time clock	<ul style="list-style-type: none"> ■ Standard
Internal font	<ul style="list-style-type: none"> ■ 8 alpha-numeric bitmap fonts ■ Monotype Imaging® true type font engine with one CG Triumvirate Bold Condensed scalable font
Bar code	<p>1D bar code</p> <p>Code 11, Code 39, Code 49, Code 93, Code128UCC, Code128 subsets A.B.C, Codabar, Standard 2 of 5, Industrial 2 of 5, Interleave 2 of 5, EAN-8, EAN-13, EAN-14, EAN-128, ITF14, UPC-A, UPC-E, EAN and UPC 2(5) digits add-on, MSI, PLESSEY, PLANET, POSTNET, RSS-Stacked, GS1 DataBar, China Post, Telepen, LOGMARS</p> <p>2D bar code</p> <p>PDF-417, Micro PDF 417, Maxicode, DataMatrix, QR code, Aztec, TLC 39, RSS</p>
Font & bar code rotation	0, 90, 180, 270 degree
Command set	TSPL-EZD (Compatible to EPL, ZPL, ZPL II, DPL)
Media type	Continuous, die-cut, black mark, fan-fold, notch (outside wound)

Media width	20 mm ~ 114 mm (0.8" ~ 4.5")		
Media thickness	0.076 ~ 0.305 mm (2.99 ~ 12.01 mil)		
Label length	5 ~ 25,400 mm (0.2" ~ 1,000")	5 ~ 11,430 mm (0.2" ~ 450")	5 ~ 2,540 mm (0.2" ~ 100")
Environment condition	Operation: 0 ~ 40 °C (32~ 104°F), 25~85% non-condensing Storage: -40 ~ 60 °C (-40 ~ 140°F), 10~90% non-condensing		
Safety regulation	BSMI 、CCC 、CE Class A 、EAC 、FCC Class A , BIS, KC , cTUVus(UL62368-1), Mexico COC		
Accessories	<ul style="list-style-type: none"> ■ Windows labeling software CD disk ■ Quick start guide ■ USB port cable ■ Power cord 		
Factory option	<ul style="list-style-type: none"> ■ Bluetooth BT5.0 MFi 		
Dealer option	<ul style="list-style-type: none"> ■ Internal 802.11a/b/g/n/ac + Bluetooth 4.2 wireless module kit ■ GPIO (DB25F) 		

2. Operation Overview

2.1 Unpacking and Inspection

This printer has been specially packaged to withstand damage during shipping. Please carefully inspect the packaging and printer upon receiving the bar code printer. Please retain the packaging materials in case you need to reship the printer.

Unpacking the printer, the following items are included in the carton.

- 1 Printer unit
- 1 Quick installation guide
- 1 Power cord
- 1 USB interface cable
- 1 CD unit

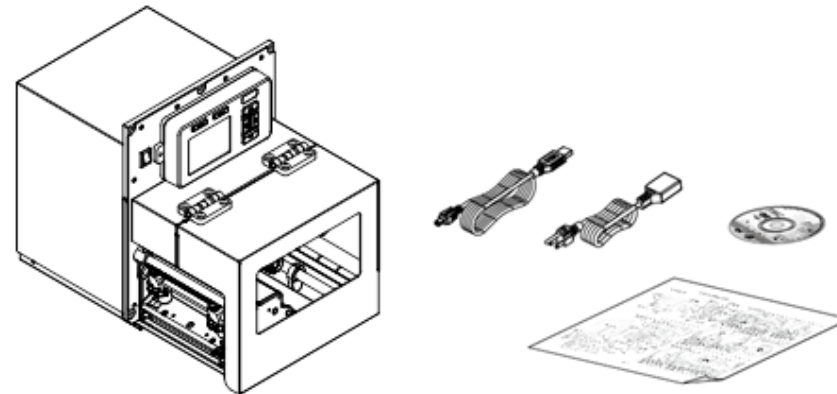

If any parts are missing, please contact the Customer Service Department of your purchased reseller or distributor.

2.2 Print Engine Orientation

The PEX-1001 series are available in a left-hand configuration and a right-hand configuration.

PEX-1121/ PEX-1131/ PEX-1161 series

Left-hand model

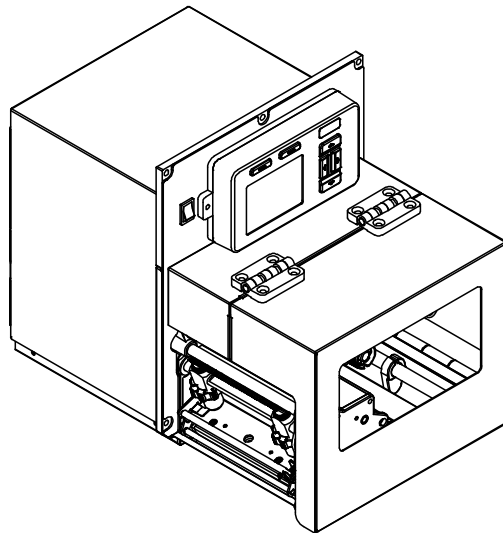

PEX-1221/ PEX-1231/ PEX-1261 series

Right-hand model

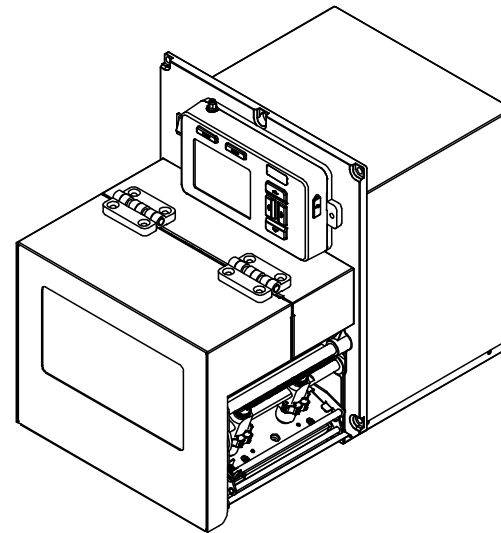

Note:

This document is going to show the components inside the media compartment of a left-hand print engine. A right-hand unit contains a mirror image of those components. Familiarize yourself with these components before continuing with the print engine setup procedure.

2.3 Checking the Installation Space

Please check the space for mounting the print engine into an applicator. Please refer to the dimensions in this section.

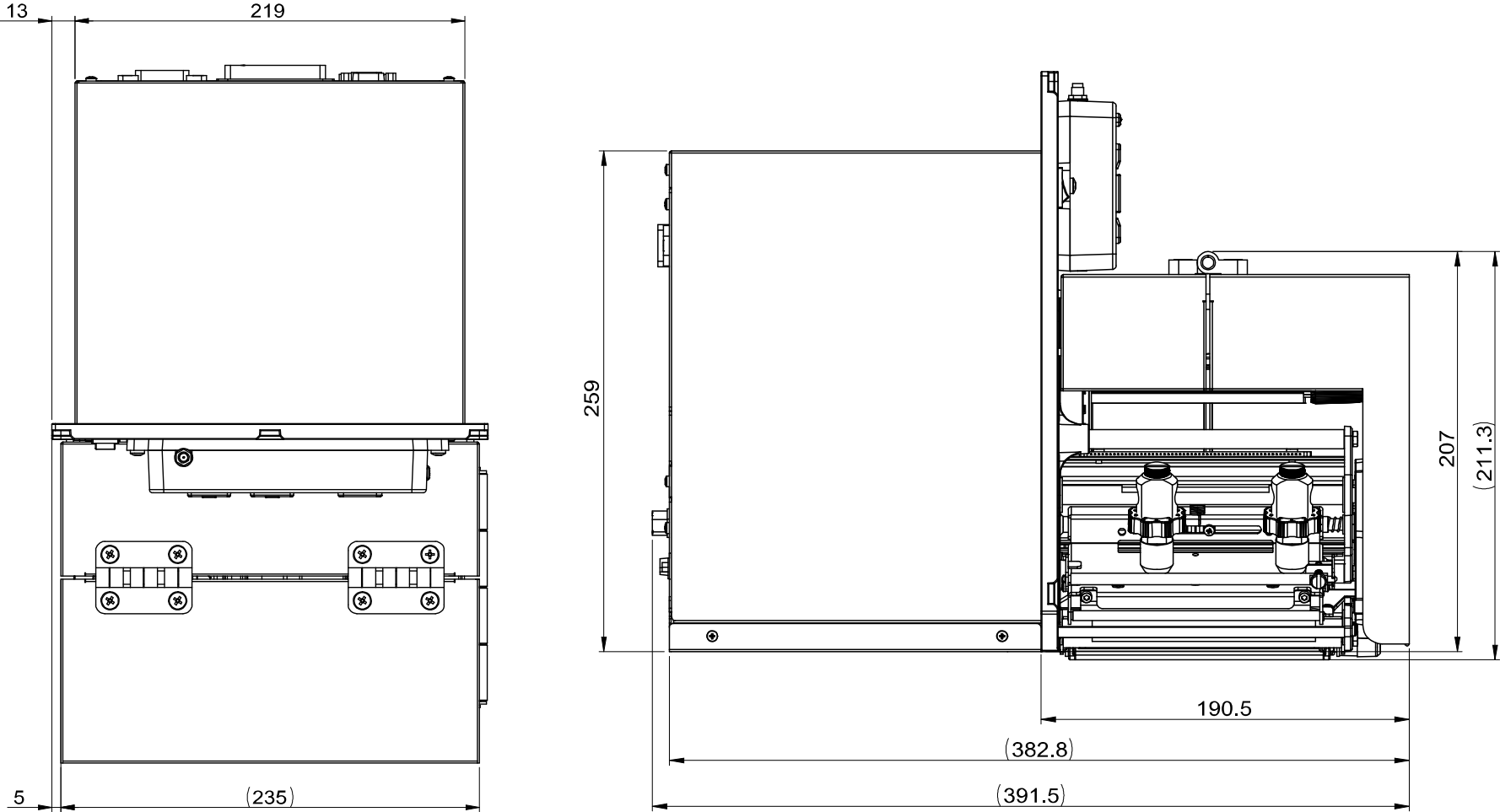

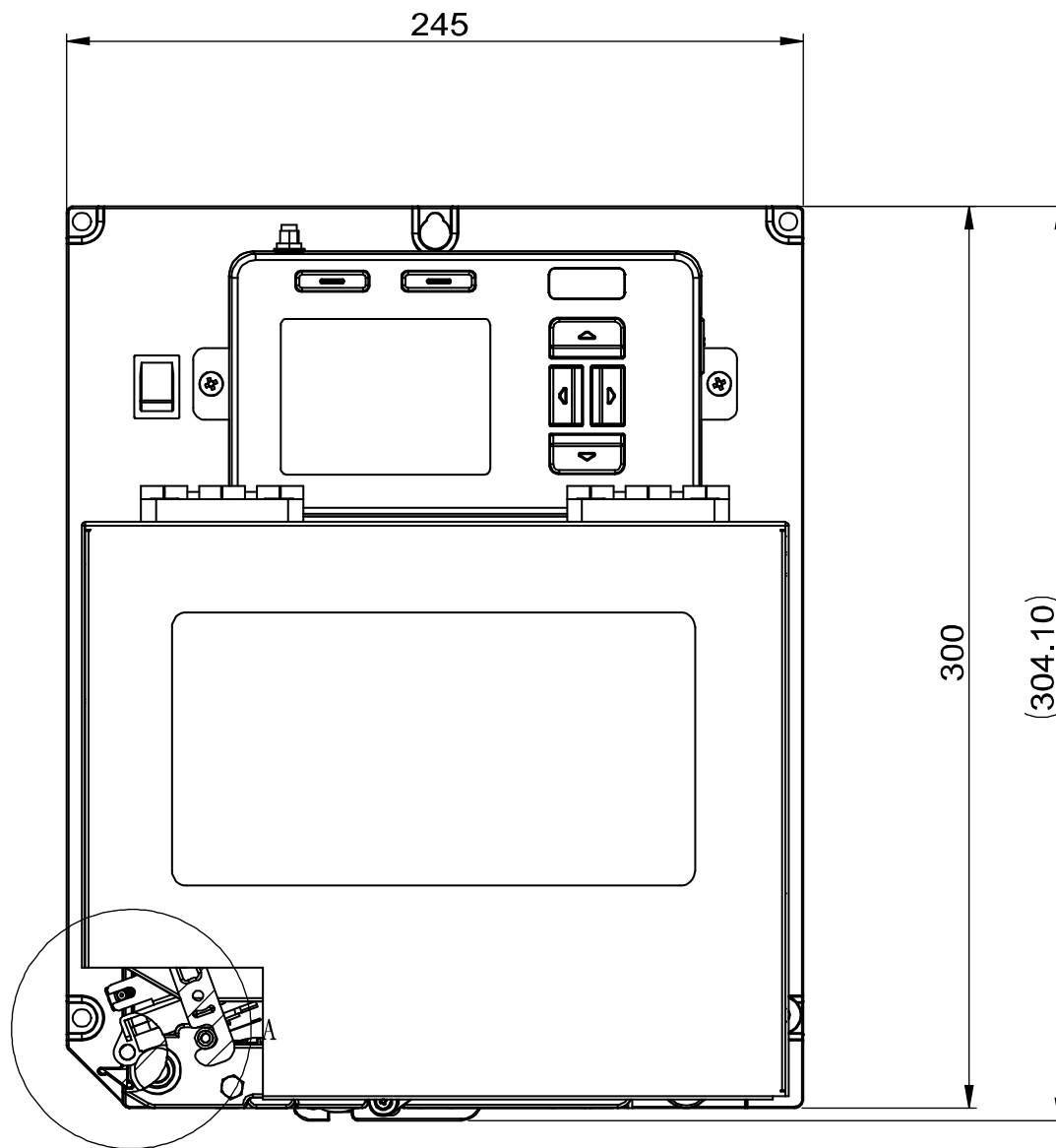
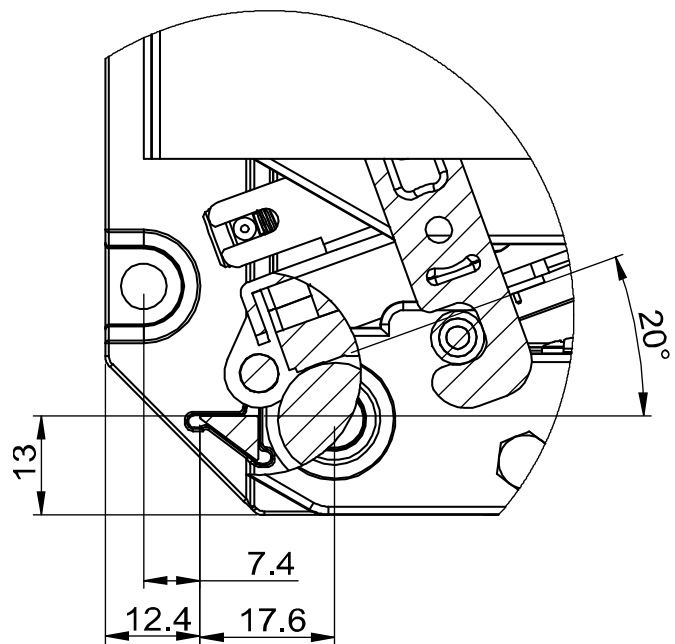

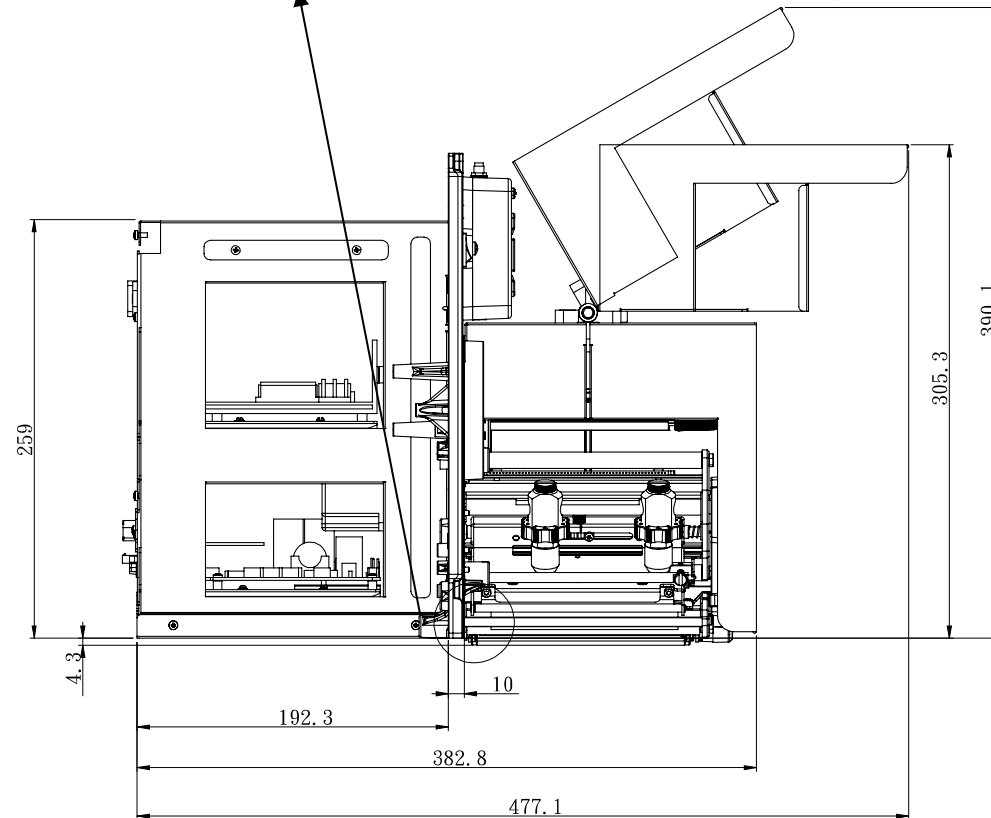
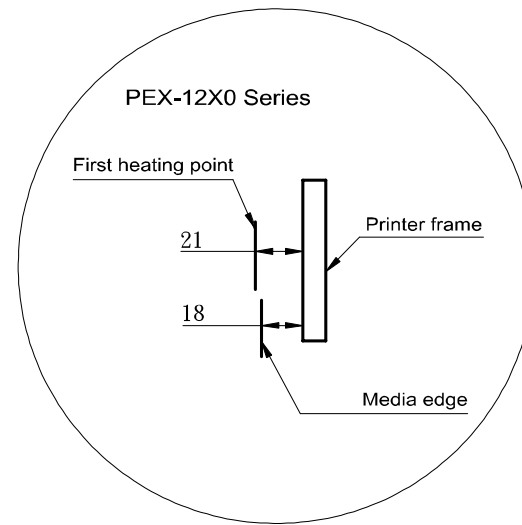
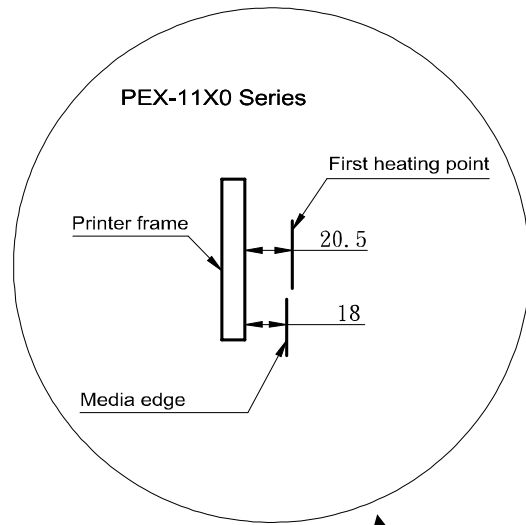

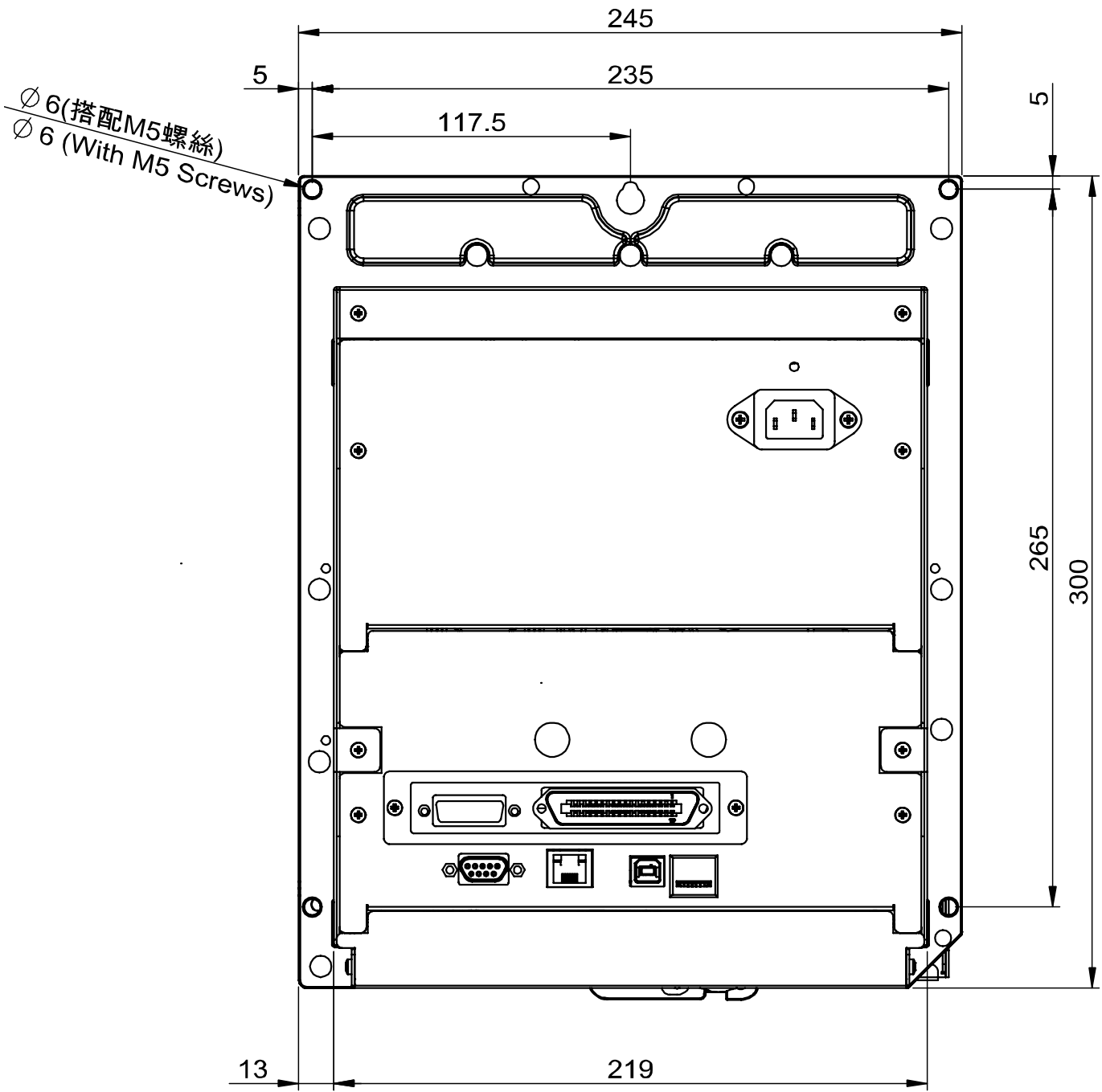

2.4 Printer Overview

2.4.1 Front View

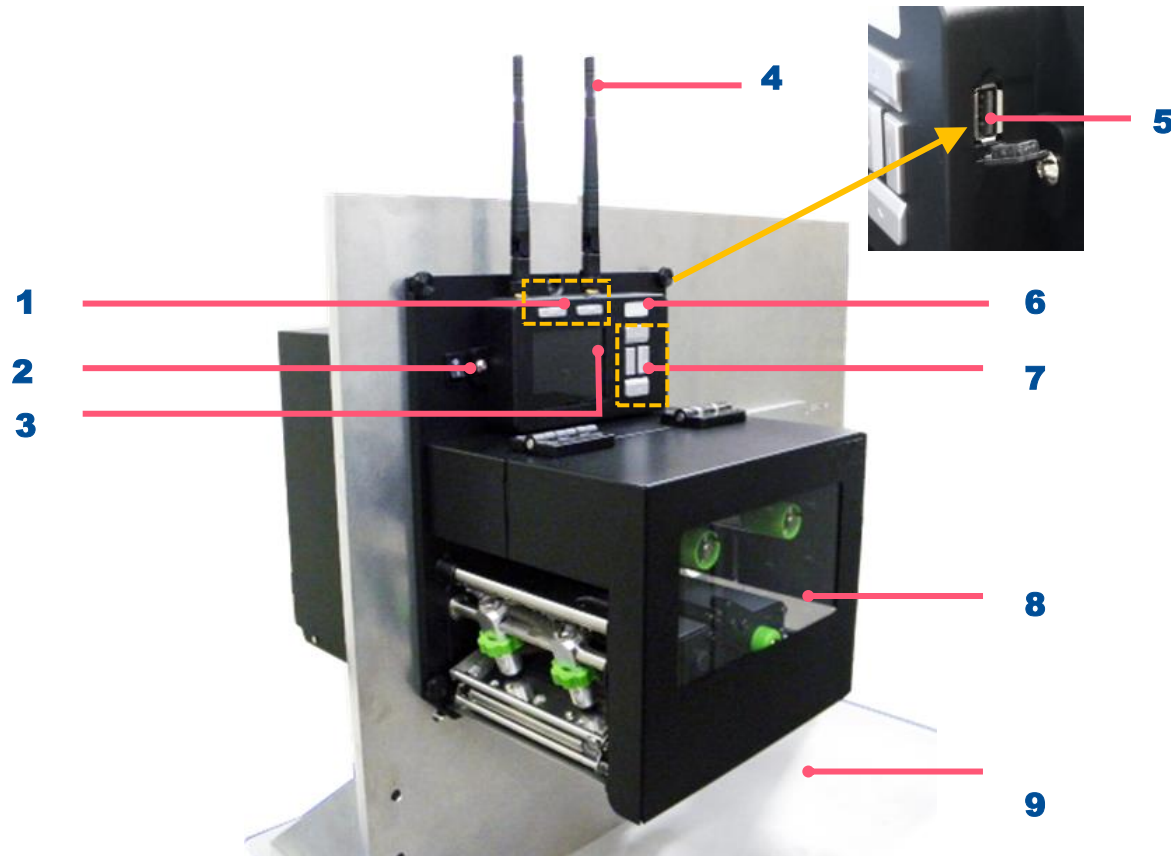

1. Soft keys
2. Power switch
3. LCD display
4. Wi-Fi antenna (option)
5. USB host
6. LED indicator
7. Navigational keys
8. Media view window
9. Print engine cover

2.4.2 Interior View

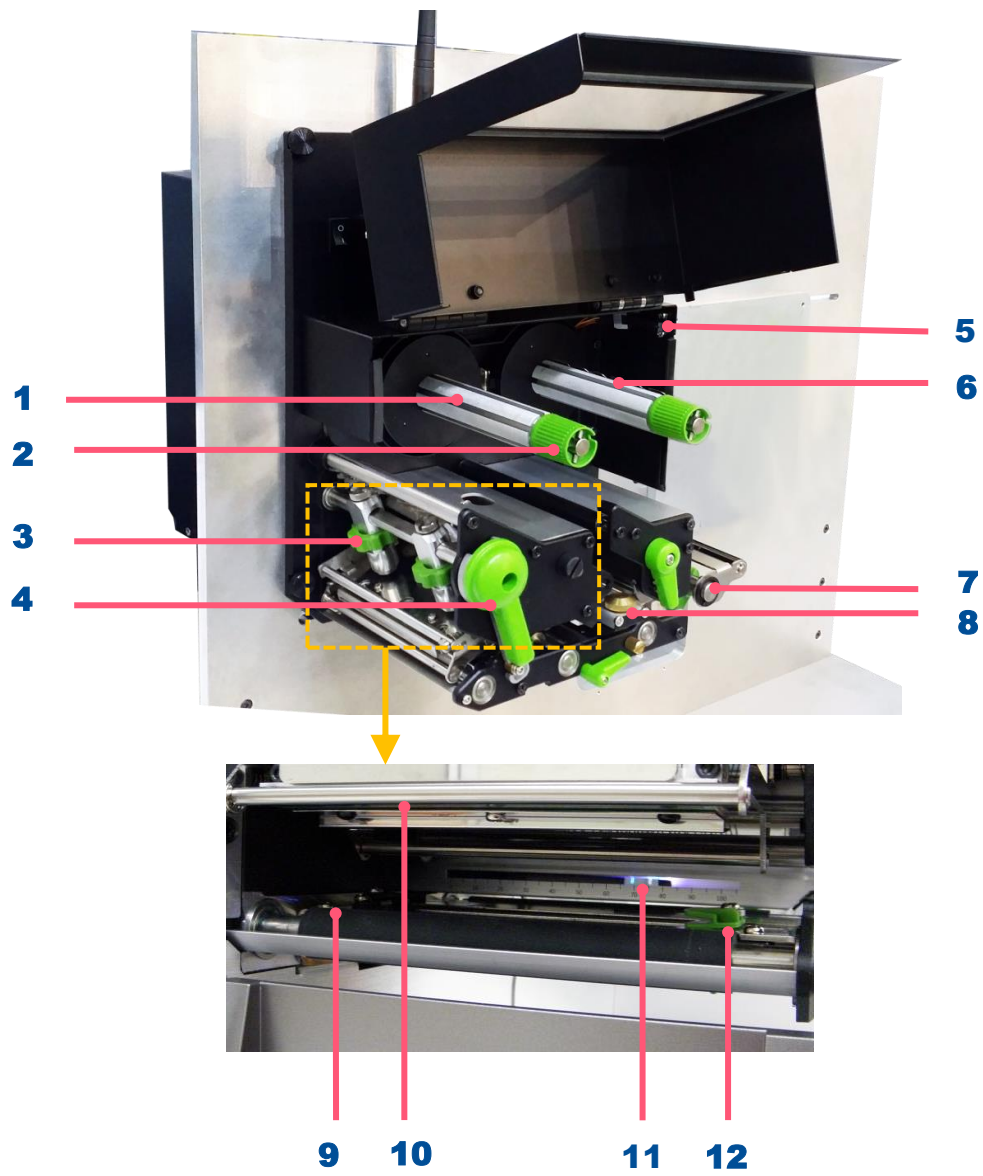

- 1. Ribbon rewind spindle
- 2. Ribbon tension adjustment knobs
- 3. Print head pressure adjustment knobs
- 4. Print head release lever
- 5. Print engine cover open sensor
- 6. Ribbon supply spindle
- 7. Label guide bar release lever
- 8. Media sensor position adjustment knob
- 9. Platen roller
- 10. Print head
- 11. Media sensor Black mark :Blue ; Gap: White)
- 12. Label guide

2.4.3 Rear View

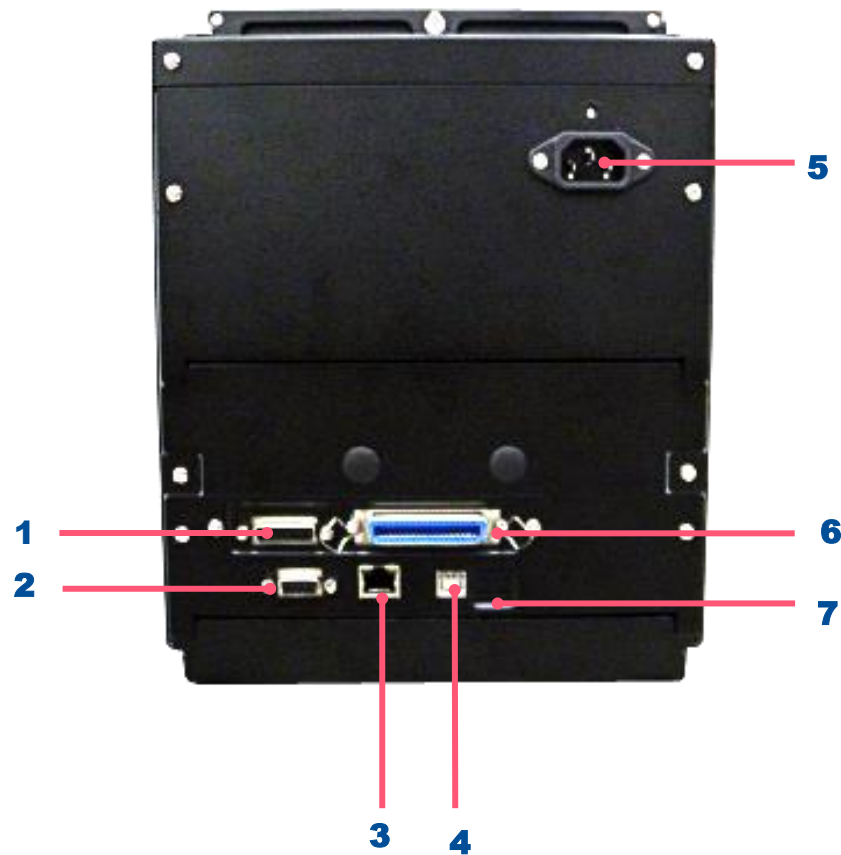

1. GPIO interface (Applicator interface with DB15F connector +5V I/O)
2. RS-232C interface
3. Ethernet interface
4. USB interface
5. Power cord socket
6. Centronics interface
7. Micro SD card socket

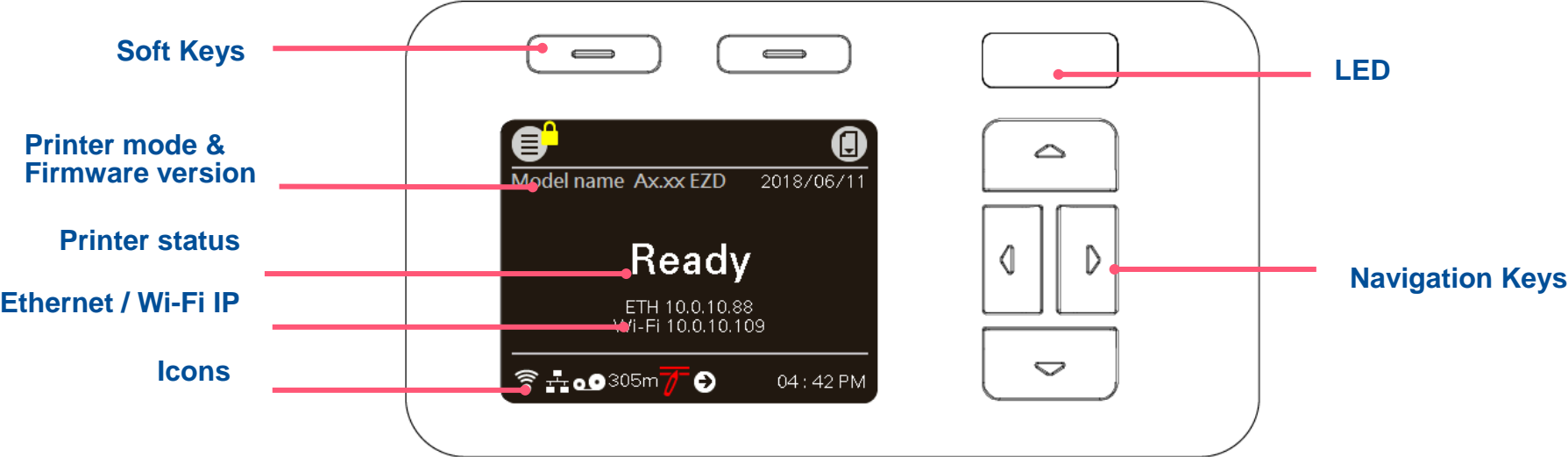

Note:
The interface picture here is for reference only. Please refer to the product specification for the interfaces availability.

2.5 Operator Control



2.5.1 LED Indication and Keypads







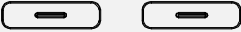
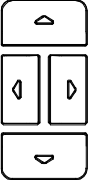



LED color indication:

Color	Meaning
 (Green)	Solid: Power is on and ready to be used. Flash : System is downloading data or printer is paused.
 (Amber)	System is clearing data.
 (Red)	Solid - Printer head open, cutter error. Flash - Printing error, such as paper empty, paper jam, ribbon empty, or memory error etc.

Keys

Keypads form	Item name	Function
	Soft keys	The display will show the function for left and right key. The meaning of the soft keys will depend on the UI screen.
	Navigational keys	Select / Navigate

Main Page Icon

Icon	Indication
	Wi-Fi device is ready (option).
	Ethernet is connected.
	Bluetooth device is ready (option).
	Remaining amount of ribbon(m).
	Pending documents in the printer
	Security lock.
	Print head cleaning notice
	Print engine cover open
	Enter the menu.
	Enter cursor (be marked in green) located option.
	Feed button (advance one label).

3. Setup

3.1 Setting up the printer

1. Refer to the section 2.3 to install the print engine to an applicator.
2. Make sure the power switch is off.
3. Connect the print engine to the computer with the provided USB cable or available connections.
4. Plug the power cord into the AC power cord socket at the rear of the print engine, and then plug the power cord into a properly grounded power outlet.

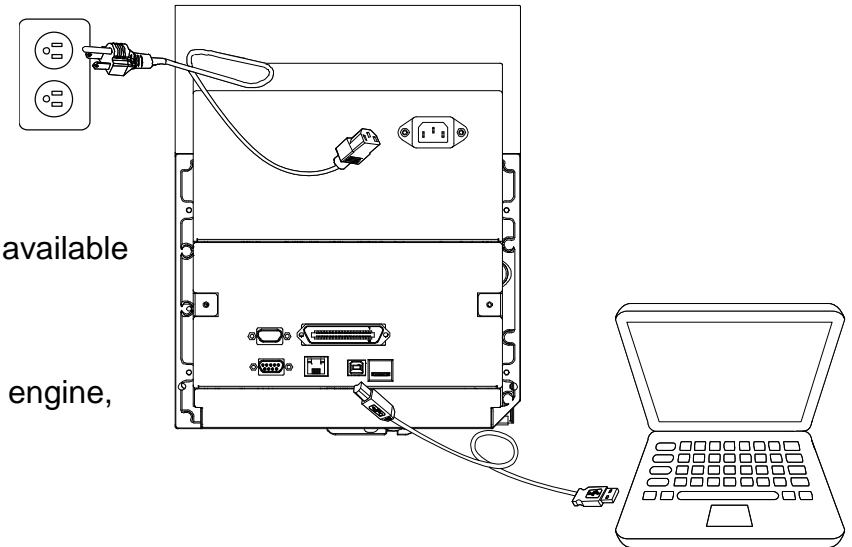

◆ **Note: Please switch OFF the printer before plugging in the power cord to printer power jack.**

3.2 Loading the Ribbon

1. Open the media cover.

Left-hand model

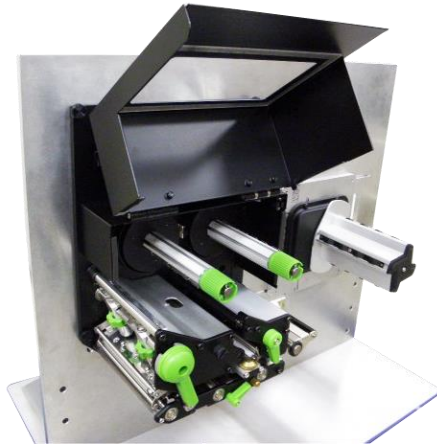

Right –hand model

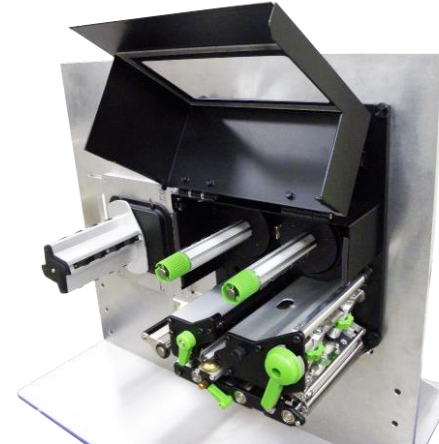

2. Install the ribbon and paper core onto ribbon supply spindle and ribbon rewind spindle.

Left-hand model

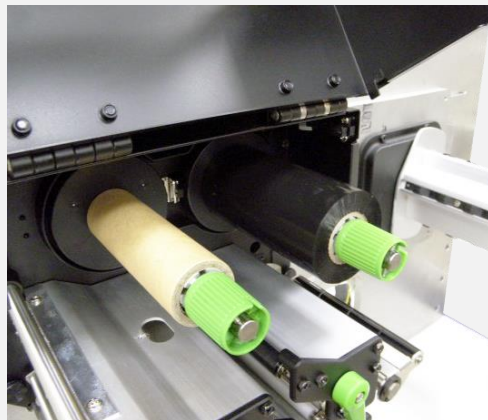

Right –hand model

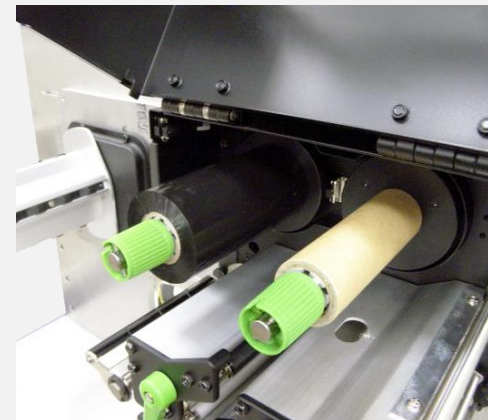

3. Install the ribbon and paper core onto ribbon supply spindle and ribbon rewind spindle.

Left-hand model

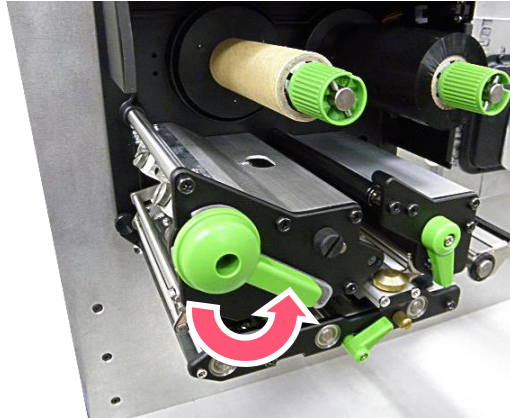

Right-hand model

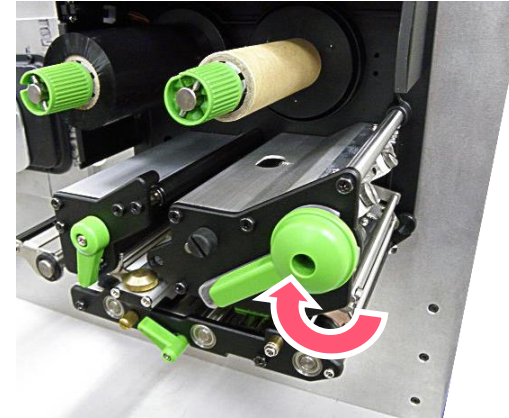

4. Thread ribbon above the ribbon guide bar and through ribbon sensor slot.

Left-hand model

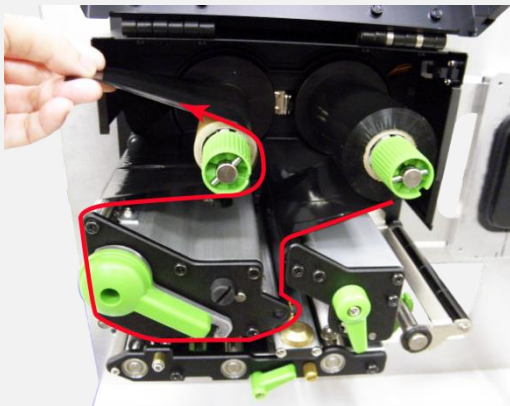

Right-hand model

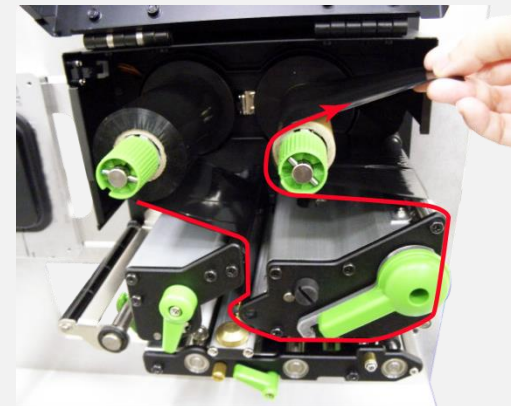

- 5. Wind the ribbon rewind spindle counterclockwise roughly 3~5 circles until ribbon is smooth, properly stretched and wrinkle-free.**

Left-hand model

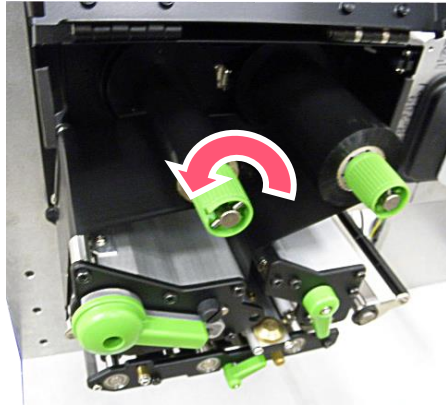

Right -hand model

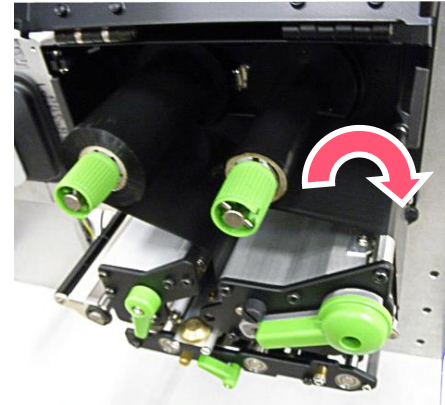

- 6. Close the print head mechanism by pushing the print head release lever.**

Left-hand model

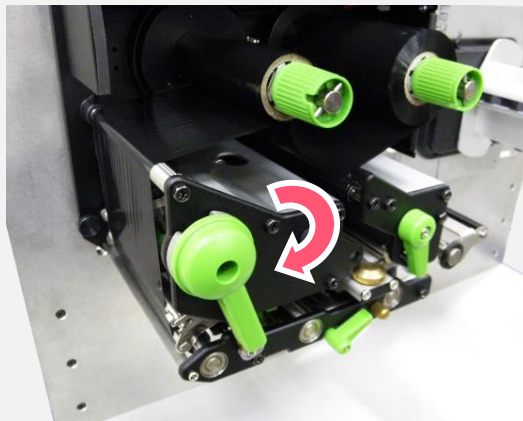

Right -hand model

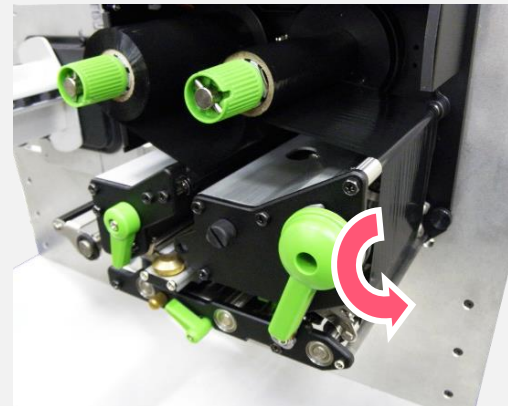

Ribbon Loading Path

Left –hand model

* Ink coated outside wound

* Ink coated inside wound

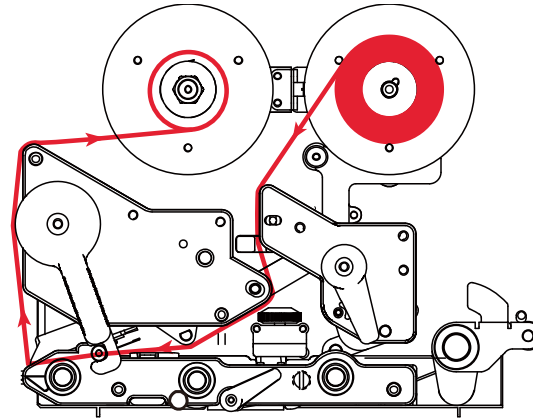
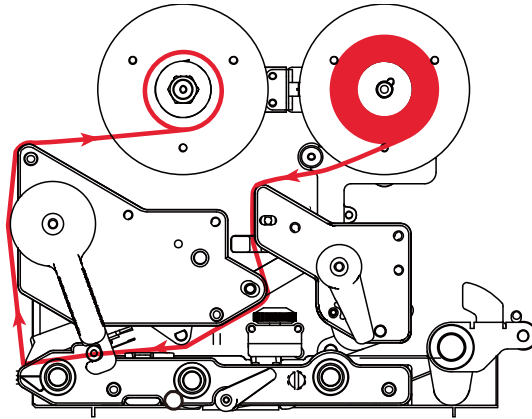

Right –hand model

* Ink coated outside wound

* Ink coated inside wound

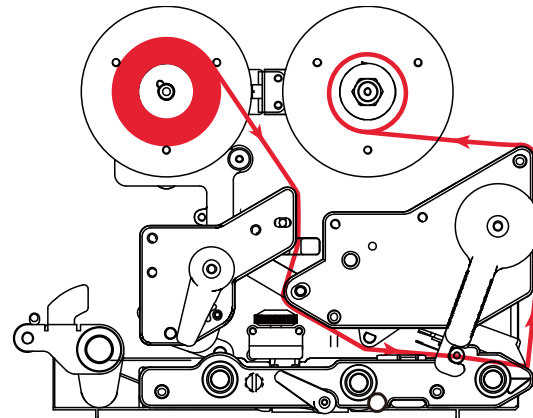
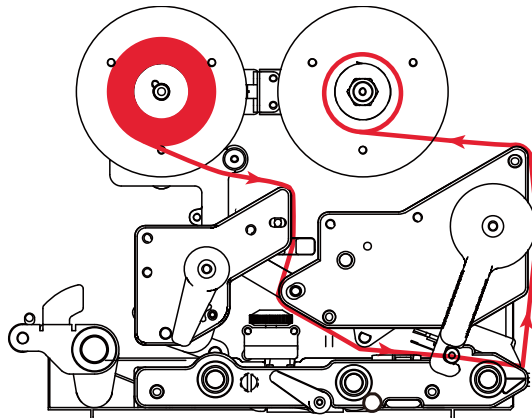

3.3 Loading the Media

1. Open the media cover.

Note: There is no media supply spindle for standard model.

Left-hand model

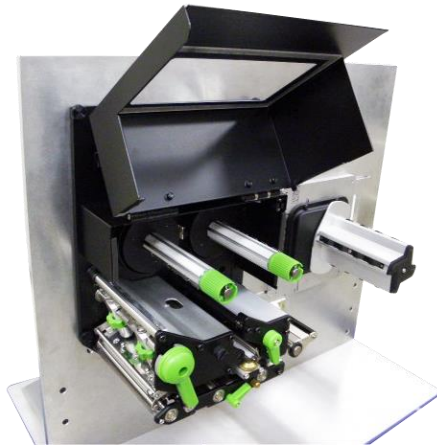

Right –hand model

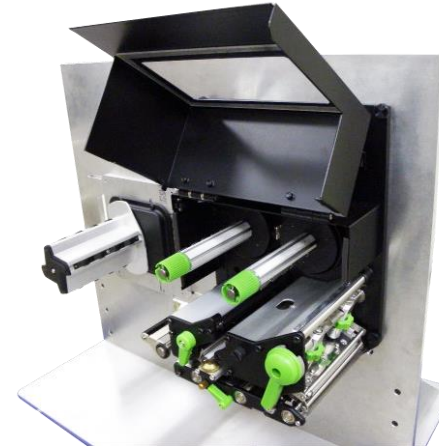

2. Open the print head release lever and label guide bar release lever for loading media.

Left-hand model



Right –hand model



- 3. Thread the leading edge of the label through the media guide bar pass media sensor, and place the leading edge onto the platen roller.**

Left-hand model

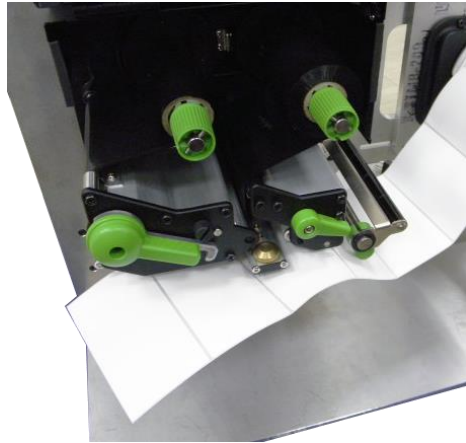

Right –hand model



- 4. Adjust the rear label guide to fit the label width.**

Left-hand model

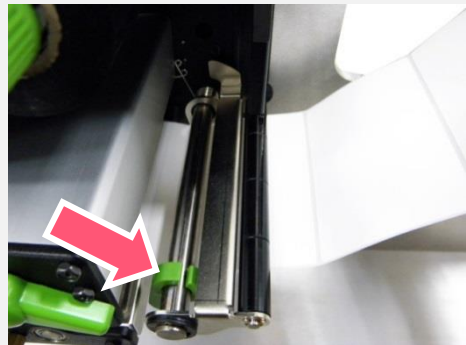

Right –hand model



5. Adjust the front label guide (green) to fit the label width.

Left-hand model



Right –hand model



6. Move the media sensor by adjusting the media sensor position adjustment knob, make sure the sensor is able to sense the media.

Left-hand model



GAP (White)
Black mark (Blue)

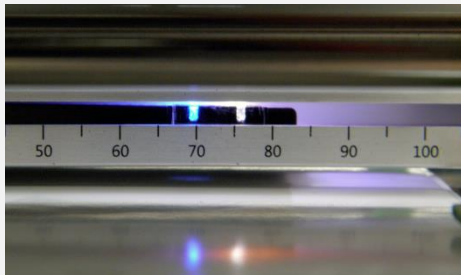

Right –hand model

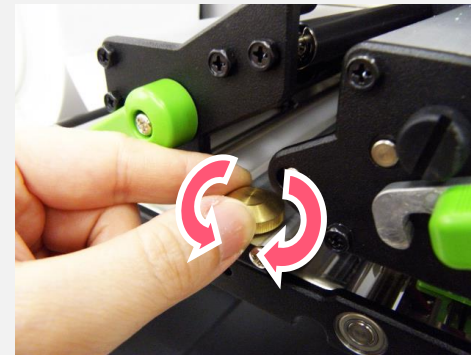

GAP (White)
Black mark (Blue)

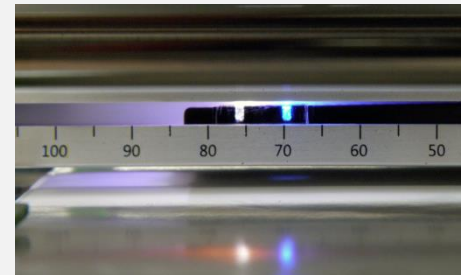

- 7. Close print head release lever and label guide bar release lever.
 - 8. Set media sensor type and calibrate the selected sensor.
- Note * Please calibrate the gap/black mark sensor when changing media.

Left-hand model



Right -hand model



Media Loading Path

Left -hand model

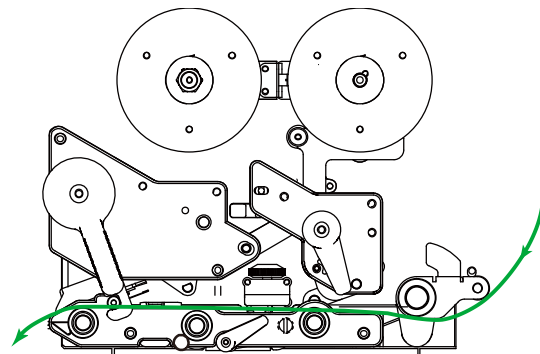

Right -hand model

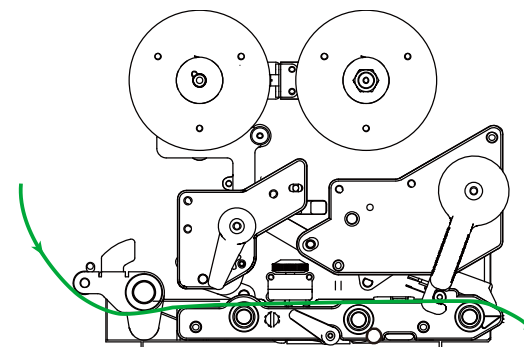

3.4 Loading Media in Peel-off Mode (Option)

1. Open the media cover and refer chp.3.3 to load the media.
Note: There is no media supply spindle for standard model.

Left-hand model

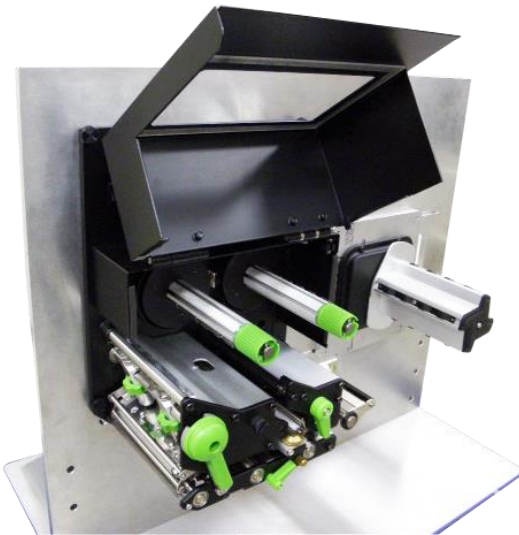

Right –hand model

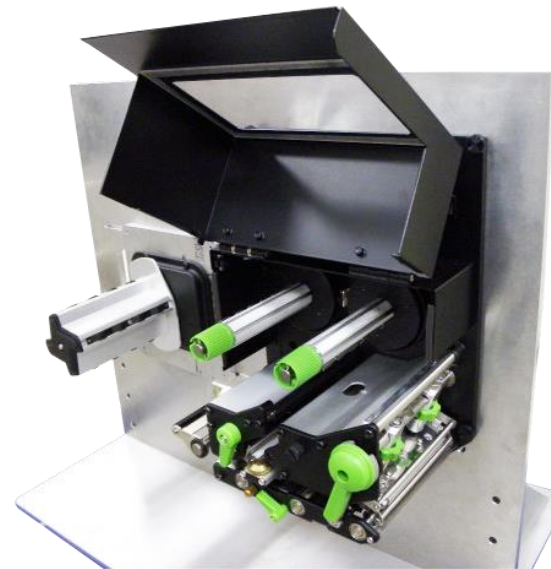

- 2. Open print head release lever and label guide bar release lever to thread the label through the front of the print engine and remove several labels.**

Left-hand model

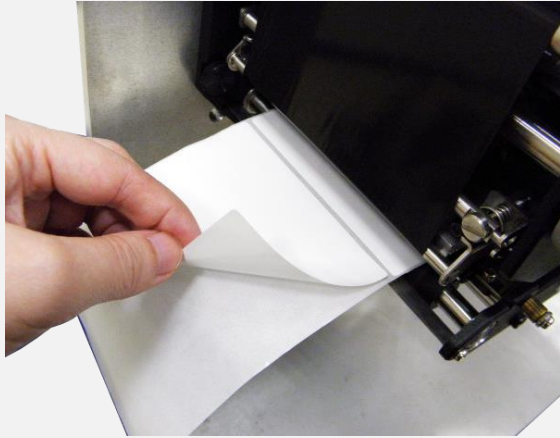

Right –hand model

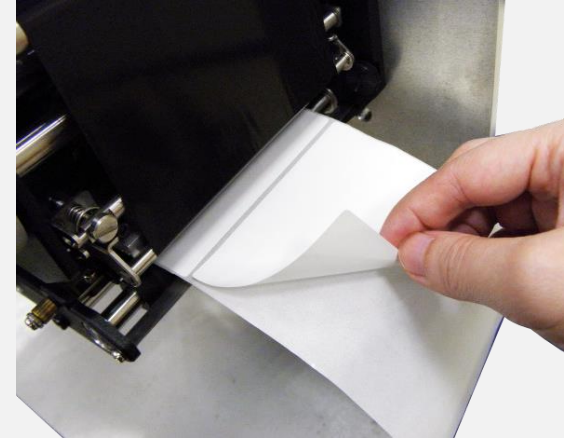

- 3. Open the peel-off roller release lever.**

Left-hand model



Right –hand model

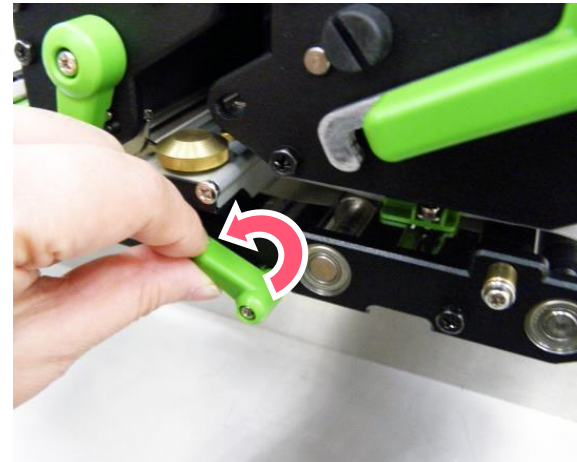

4. Feed the leading edge of liner through the peel-off roller.

Left-hand model

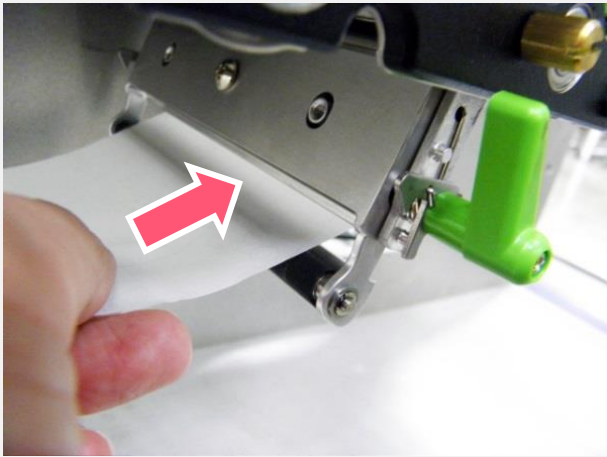

Right-hand model

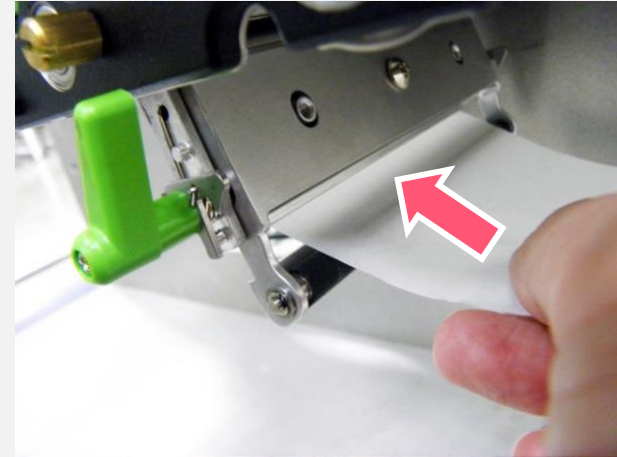

5. Press the roller to close the peel-off roller release lever.

Left-hand model

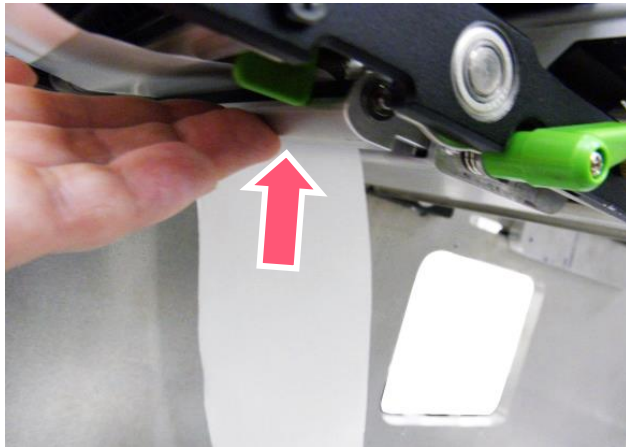

Right-hand model

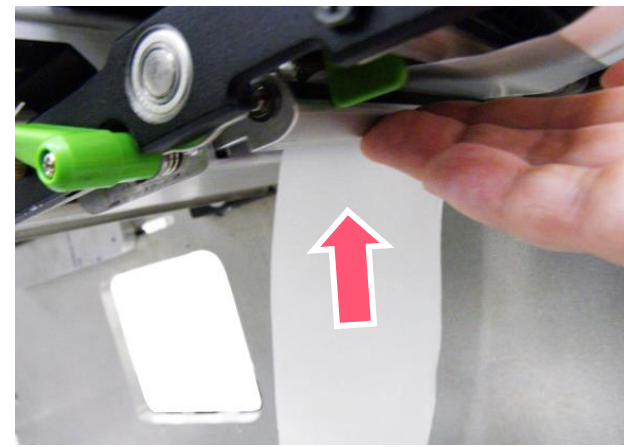

6. Close print head release lever and label guide bar release lever and press Feed button to test.

Left-hand model

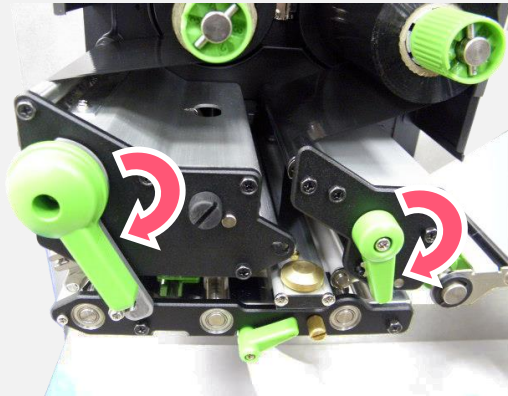

Right-hand model

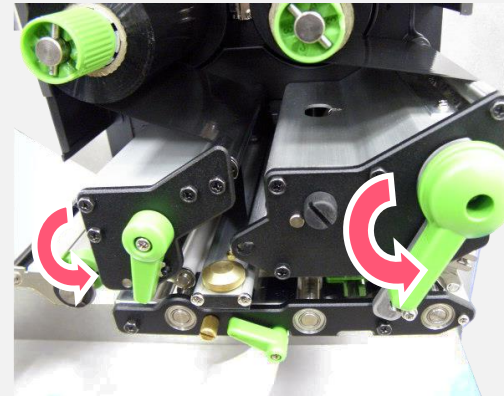

Media Loading Path for Peel-off Mode

Left-hand model

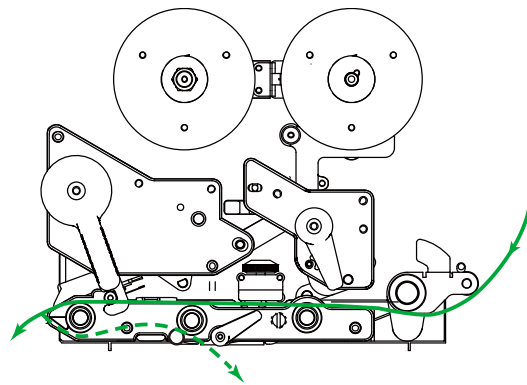

Right-hand model

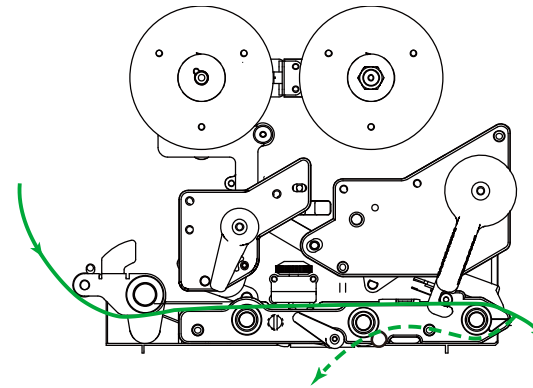

4. Knob Adjustment

Print Head Pressure Adjustment Knob has 5 levels' adjustment. Different number means different pressure to the print head . Due to media is aligned to the inbound of the printer mechanism, different media width requires the different pressure. Users can try which level can meet their expectation.

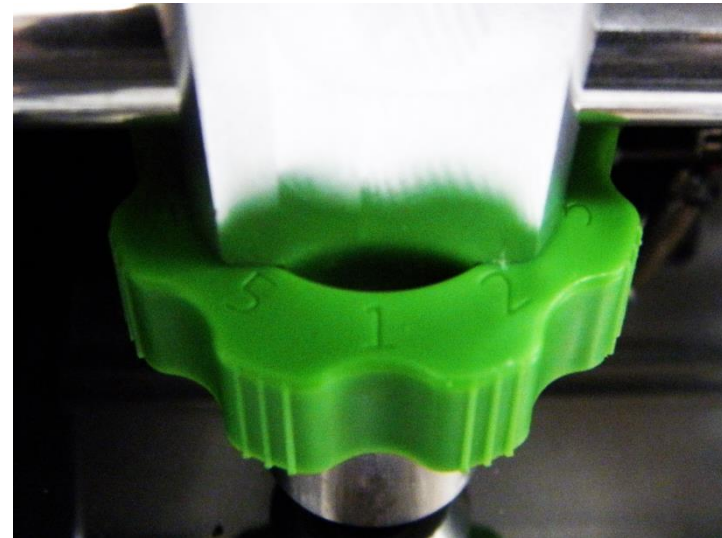
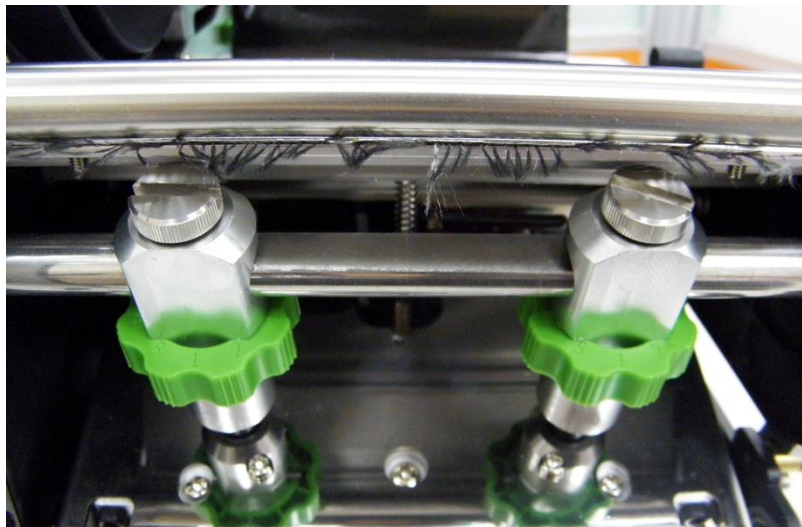

- **Pressure level: 5>4>3>2>1 (5 is the highest)**
- If the label width is 4", adjust both print head pressure to the same level.
- If the label is less than 2" wide, increase the pressure of left adjustment knob and decrease the right side pressure.

4.1 Ribbon Tension Adjustment Knob

Ribbon Tension Adjustment Knob has 3 positions for adjustment. Due to ribbon is aligned to the inbound of the printer mechanism, different ribbon or media widths require different ribbon tension to print correctly. Therefore, it may require to adjust the ribbon tension adjustment knob to avoid wrinkle and get the best print quality.

- Tension level: 1>2>3. Default: 1 (1 is the highest)

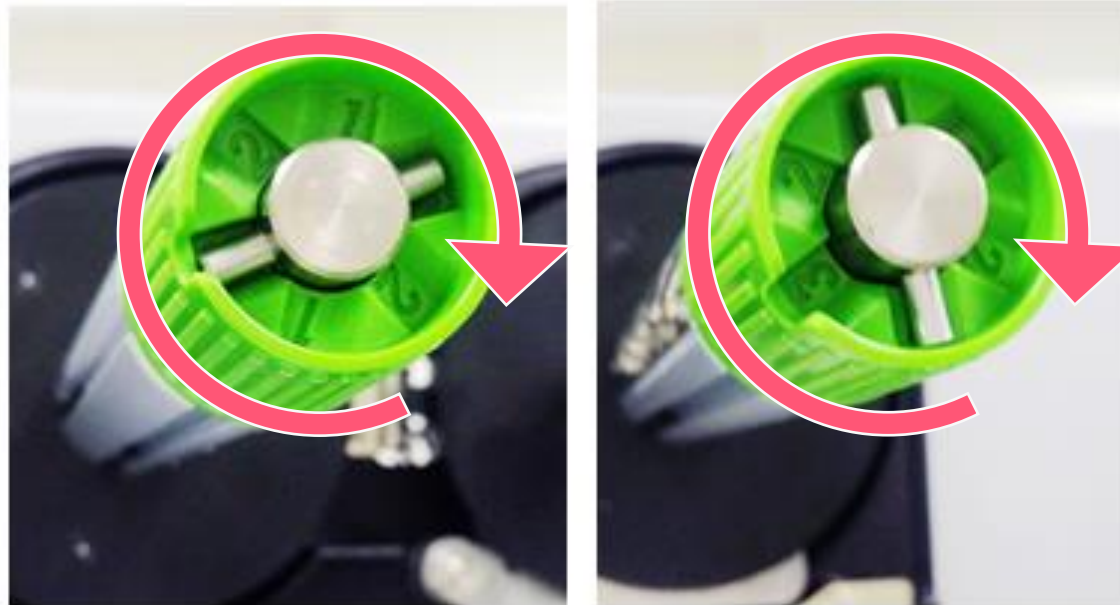

4.2 Mechanism Fine Adjustment to Avoid Ribbon Wrinkles

Ribbon wrinkle is related to the media width, thickness, print head pressure balance, ribbon film characteristics, print darkness setting...etc. In case the ribbon wrinkle happens, please follow the instructions below to adjust the printer parts.



Wrinkle happens from label lower left to upper right direction

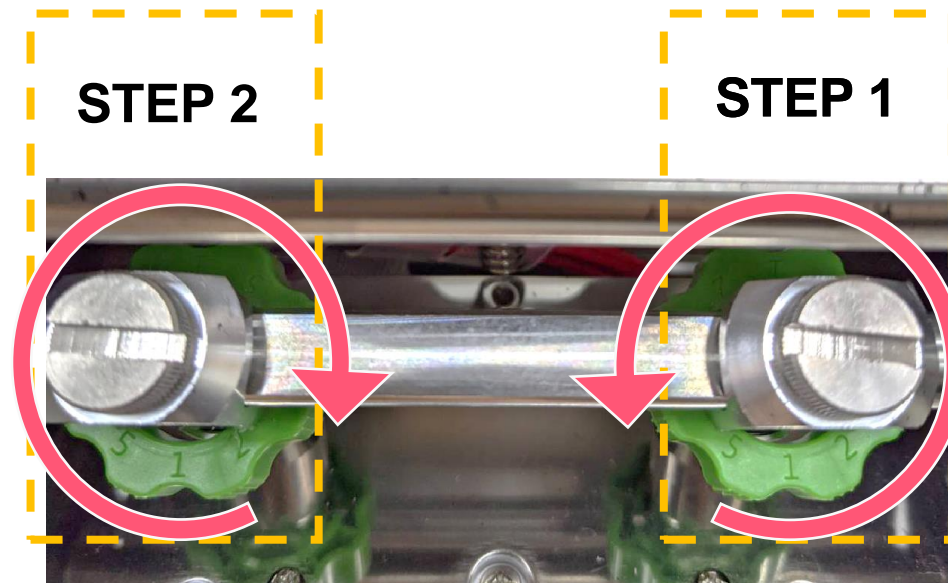

Pressure level: 5>4>3>2>1 (5 is the highest)

- **Step 1** Decrease the right side's pressure per level to check whether wrinkles is gone. adjustment knob.
- **Step 2** If right side pressure knob has been turned to level 1, but the wrinkle still exists, increase the left side pressure knob per level to check whether the wrinkle has been disappeared or not.

Wrinkle happen from label lower right to upper left direction

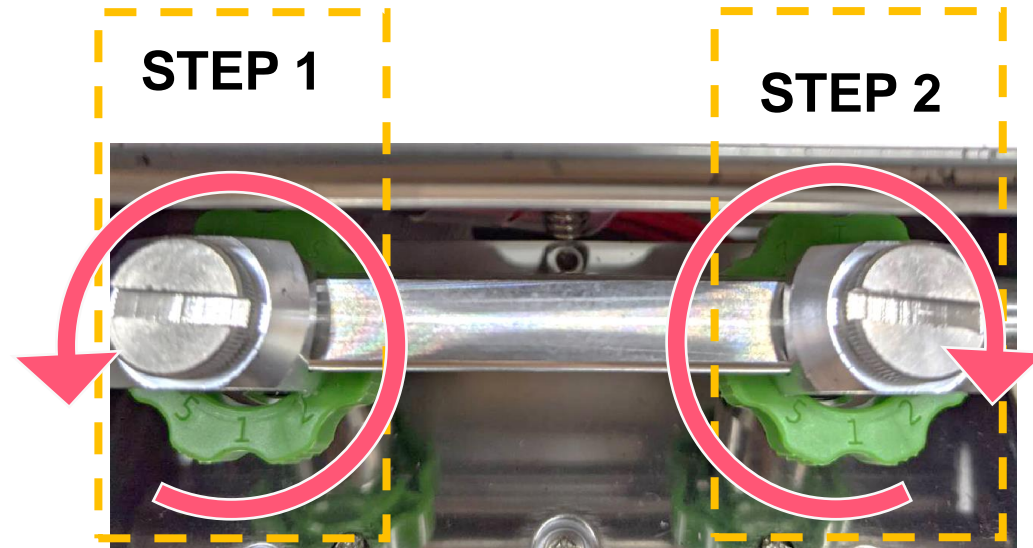
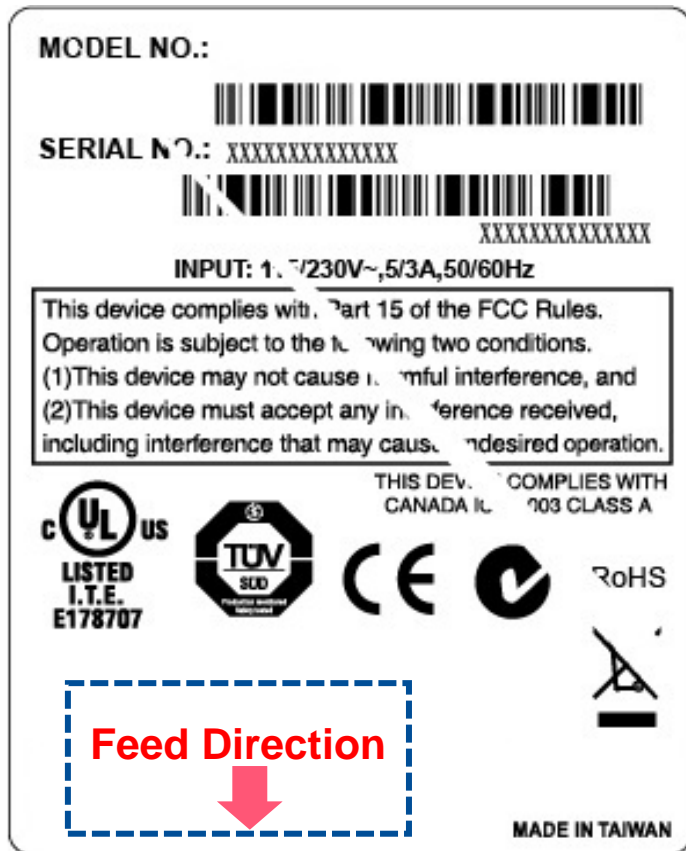

Pressure level: 5>4>3>2>1 (5 is the highest)

- **Step 1** Decrease the left side's pressure per level to check whether wrinkles is gone. adjustment knob.
- **Step 2** If right side pressure knob has been turned to level 1, but the wrinkle still exists, increase the left side pressure knob per level to check whether the wrinkle has been disappeared or not.

4.3 Suggestion of Ribbon Tension Adjustment

For 4" width ribbon

If the ribbon width is 4", adjust both ribbon tension adjustment knobs to the #1 on ribbon supply & rewind spindles. (Factory default ribbon tension is #1)

Ribbon Rewind Spindle Tension # 1

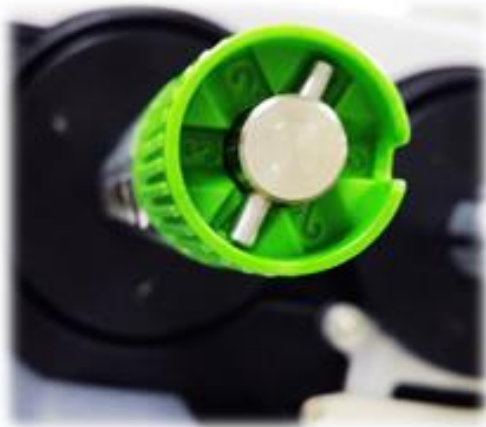

Ribbon Supply Spindle Tension # 1

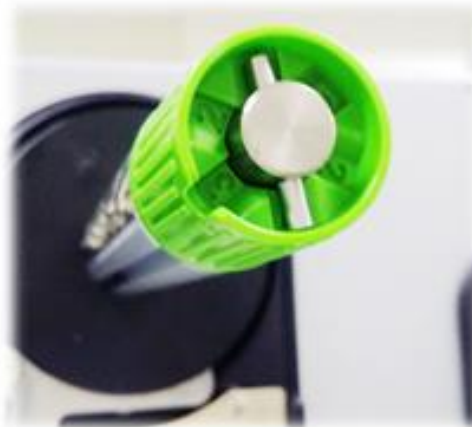

For 3" width ribbon

If the ribbon width is 3", adjust both ribbon tension adjustment knobs to the #2 on ribbon supply & rewind spindles.

Ribbon Rewind Spindle Tension # 2



Ribbon Supply Spindle Tension # 2



For 2" width ribbon

If the ribbon width is 2", adjust both ribbon tension adjustment knobs to the #3 on ribbon supply & rewind spindles.

Ribbon Rewind Spindle Tension # 3



Ribbon Supply Spindle Tension # 3



5. TSC Console

TSC Console is a management tool combining the Printer Management, Diagnostic Tool, CommTool and Printer Webpage settings, which enables you to adjust printer's settings/status; change printers' settings; download graphics, deploy fonts, graphics, label templates or upgrade the firmware to the group of printers, and send additional commands to printers at the same time.

※ **Printer firmware version before A2.12 will only use 9100 Port as command port; Printer firmware after A2.12 will use 6101 Port as command port.**

5.1 Start TSC Console

1. Double click TSC Console icon to start the software.

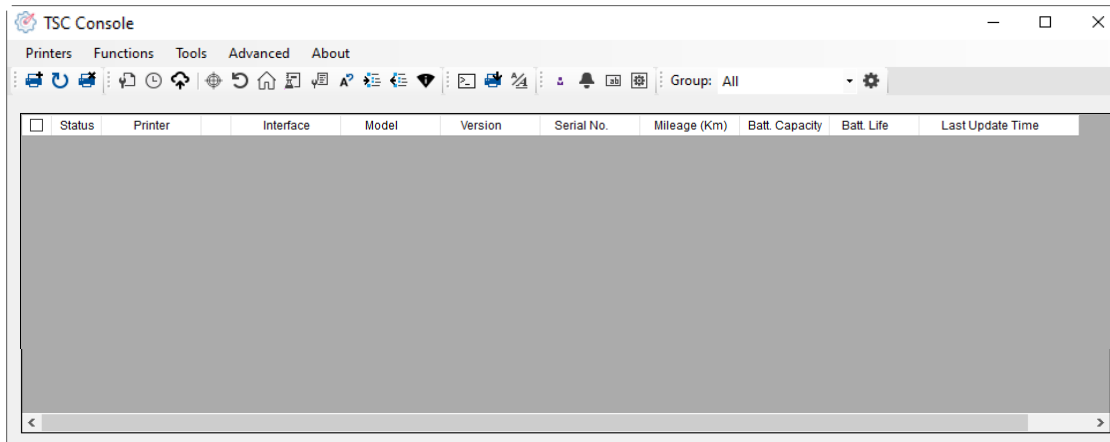

2. Manually add the devices by clicking **Printer > Add Printers**.

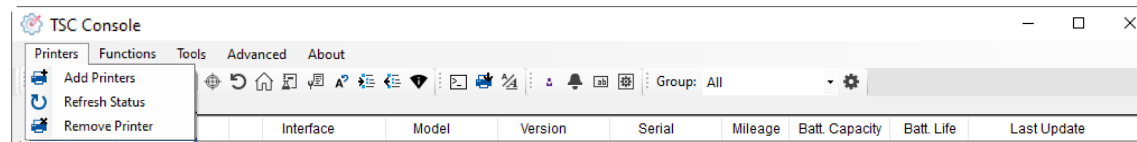

3. Select the current interface of the printer.

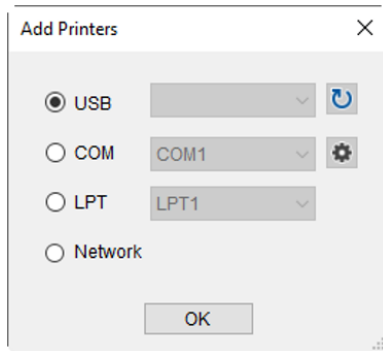

4. The printer will be added to **TSC Console**'s interface.

5. Select the printer and set the settings.

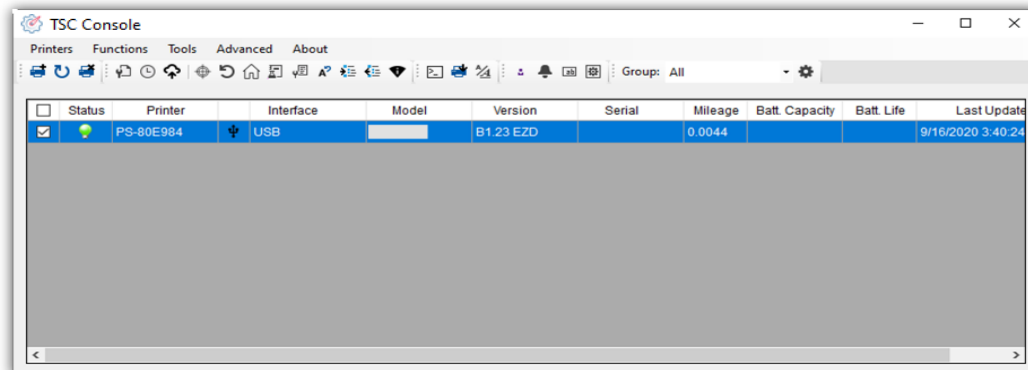

- For more information, please refer to **TSC Console User Manual**.

5.2 Setup Ethernet Interface

- Use **USB** or **COM** to establish the interface on **TSC Console**.

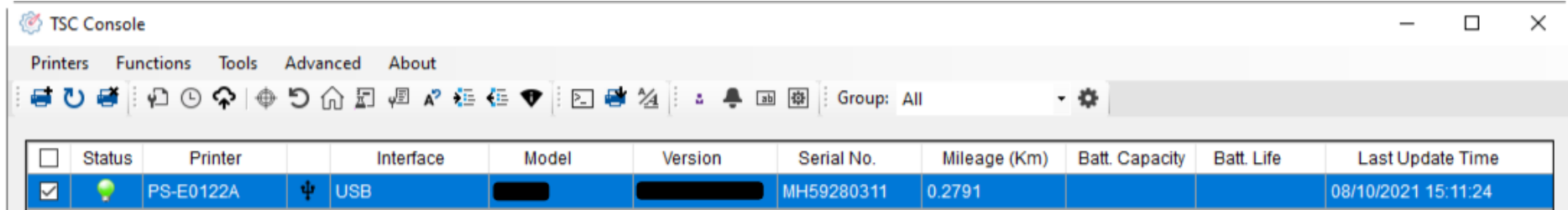

The screenshot shows the TSC Console software interface. At the top, there are menu options: Printers, Functions, Tools, Advanced, and About. Below the menu is a toolbar with various icons. A status bar at the bottom of the toolbar shows 'Group: All'. The main area contains a table with the following columns: Status, Printer, Interface, Model, Version, Serial No., Mileage (Km), Batt. Capacity, Batt. Life, and Last Update Time. The table has one row of data:

Status	Printer	Interface	Model	Version	Serial No.	Mileage (Km)	Batt. Capacity	Batt. Life	Last Update Time
<input checked="" type="checkbox"/>	PS-E0122A	USB			MH59280311	0.2791			08/10/2021 15:11:24

- Double click to enter the **Printer Configuration Page** > Click **Ethernet** tab > Check the **IP Address**.

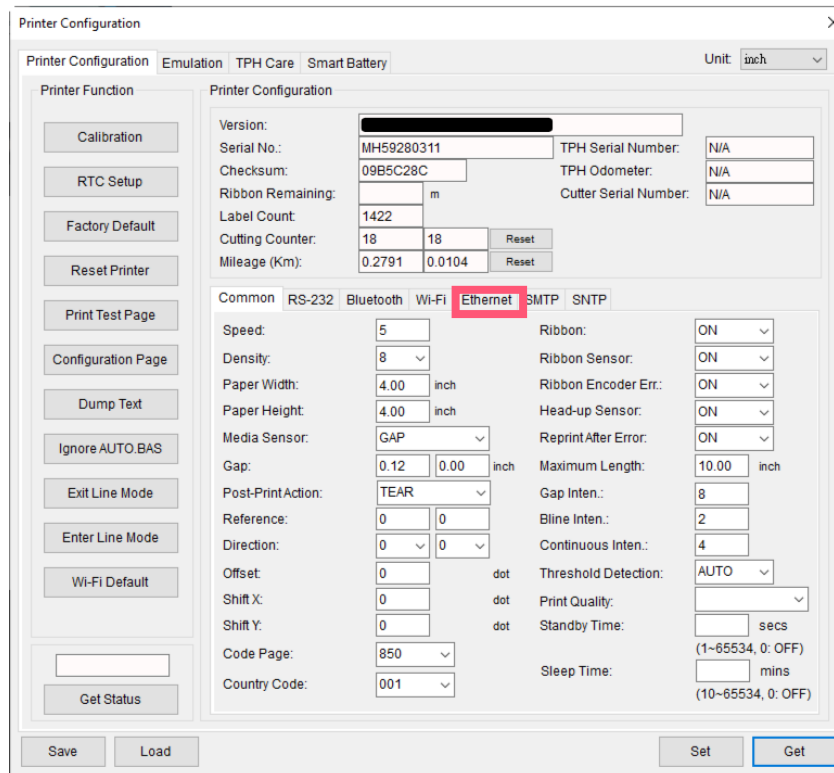

The screenshot shows the 'Printer Configuration' dialog box. It has several tabs: Printer Configuration, Emulation, TPH Care, and Smart Battery. The 'Printer Configuration' tab is active. On the left, there are buttons for Calibration, RTC Setup, Factory Default, Reset Printer, Print Test Page, Configuration Page, Dump Text, Ignore AUTO.BAS, Exit Line Mode, Enter Line Mode, and Wi-Fi Default. The main area is divided into sections for printer information and settings. The 'Ethernet' tab is selected and highlighted with a red box. The 'Ethernet' section contains the following fields:

Common	RS-232	Bluetooth	Wi-Fi	Ethernet	SMTP	SNTP
Speed: 5						
Density: 8						
Paper Width: 4.00 inch						
Paper Height: 4.00 inch						
Media Sensor: GAP						
Gap: 0.12 0.00 inch						
Post-Print Action: TEAR						
Reference: 0 0						
Direction: 0 0						
Offset: 0 dot						
Shift X: 0 dot						
Shift Y: 0 dot						
Code Page: 850						
Country Code: 001						
Ribbon: ON						
Ribbon Sensor: ON						
Ribbon Encoder Err.: ON						
Head-up Sensor: ON						
Reprint After Error: ON						
Maximum Length: 10.00 inch						
Gap Inten.: 8						
Blind Inten.: 2						
Continuous Inten.: 4						
Threshold Detection: AUTO						
Print Quality: [dropdown]						
Standby Time: [dropdown] secs						
Sleep Time: [dropdown] mins						

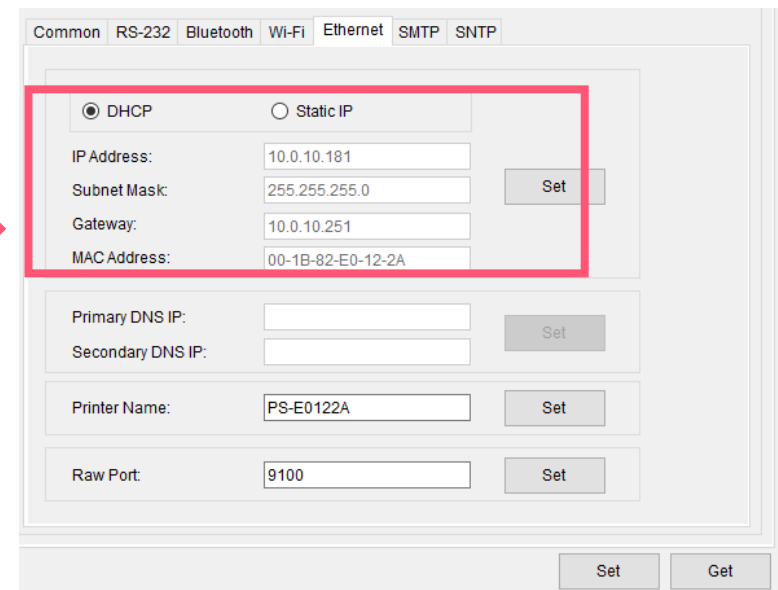

The screenshot shows the 'Ethernet' configuration window. It has tabs for Common, RS-232, Bluetooth, Wi-Fi, Ethernet, SMTP, and SNTP. The 'Ethernet' tab is active. The window contains the following fields:

Common	RS-232	Bluetooth	Wi-Fi	Ethernet	SMTP	SNTP
<input checked="" type="radio"/> DHCP <input type="radio"/> Static IP						
IP Address: 10.0.10.181						
Subnet Mask: 255.255.255.0						
Gateway: 10.0.10.251						
MAC Address: 00-1B-82-E0-12-2A						
Primary DNS IP: [dropdown]						
Secondary DNS IP: [dropdown]						
Printer Name: PS-E0122A						
Raw Port: 9100						

- Return to **TSC Console** main page > Click **Add Printer** on the top left of the window.

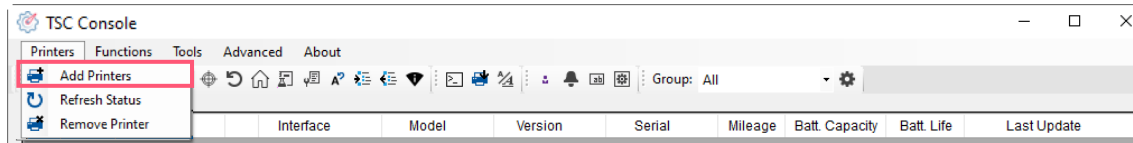

- Choose **Network** > Key in the **IP Address** > Click **Discover** to establish the Ethernet interface.

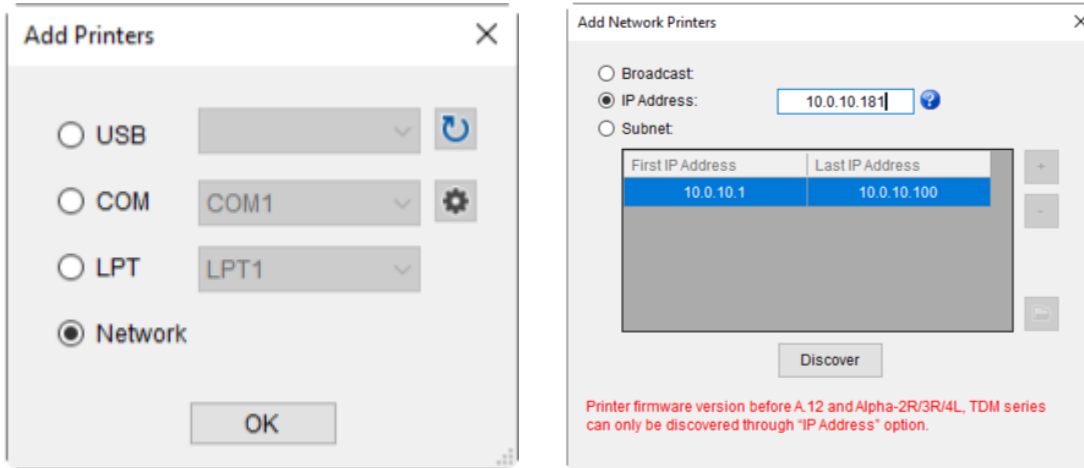

- The notification will pop up > Click **OK** to close the window > The Ethernet interface will be shown on **TSC Console**.

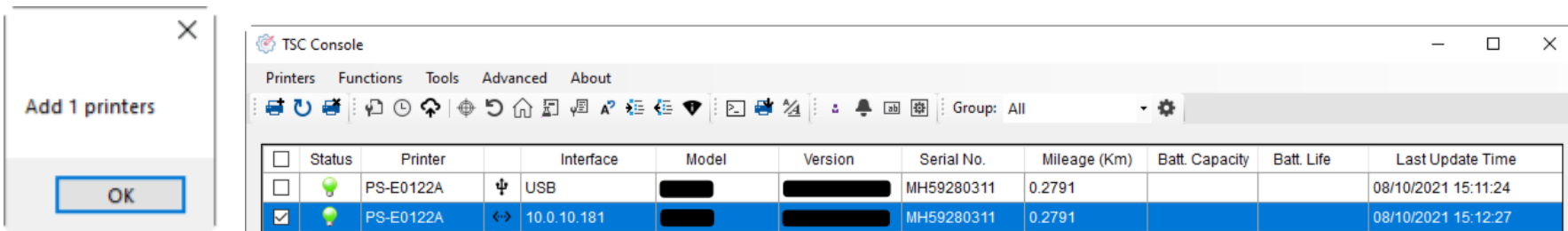

5.3 Set WiFi and Add to TSC Console Interface

- Use **USB** or **COM Port** to set up the interface.
(refer to chp.5.1)
- Double click to enter the printer configuration page.

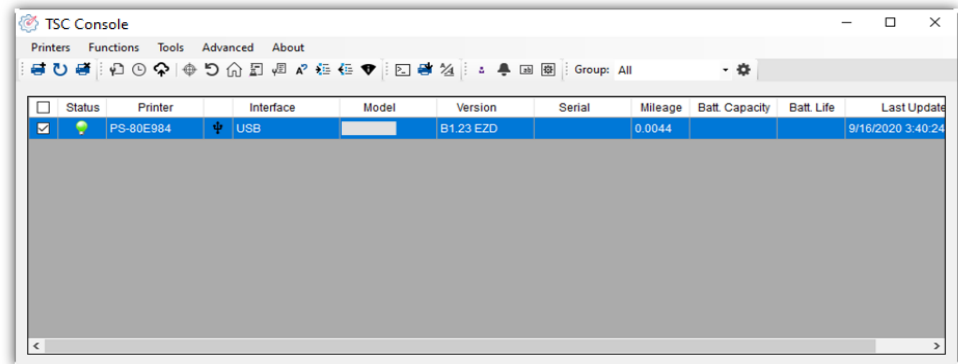

- Click **Get** to receive printer's information.
- Click **Wi-Fi** to the wi-fi setting page.

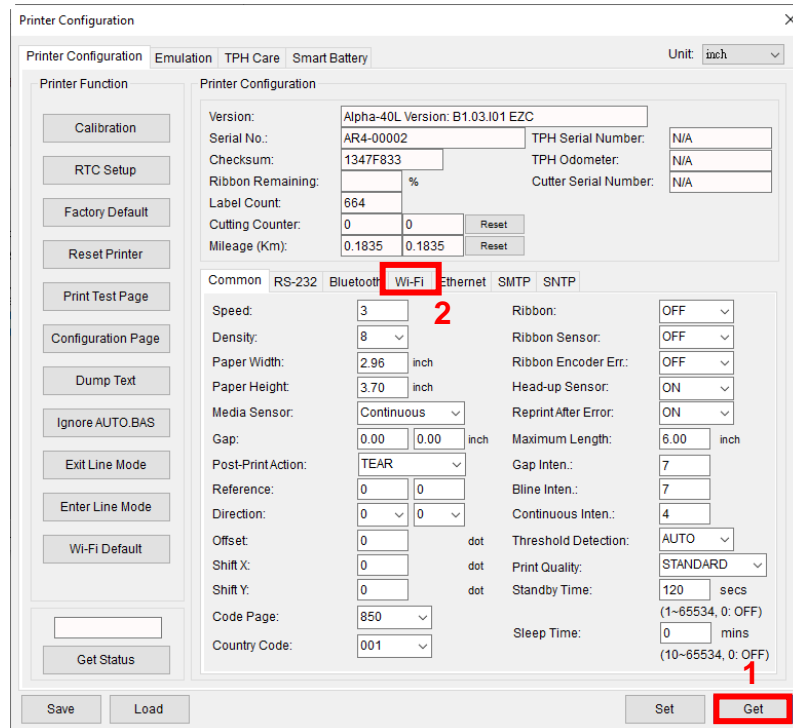

For WPA-Personal

- I. Fill-in the **SSID**.
- II. Select the Encryption option to **WPA-Personal**.
- III. Fill-in the Key.
- IV. Select **DHCP** to **ON**. (For **OFF** option, please fill-in the IP Address, Subnet Mask and Gateway)
- V. After setting, click the **Set** button.

Note:

Before setting, the entered field will be shown in yellow for reminding.

On DHCP, user can change the printer name by another model name in "Printer Name" field.

User also can change the raw port in "Raw Port" field.

Common RS-232 Bluetooth Wi-Fi Ethernet SMTP SNTP

Built-in Wi-Fi Module

SSID: SSID_1

WLAN Encryption: WPA-Personal

Key: ●●●●

DHCP: ON

IP Address: 1

Subnet Mask: 0.0.0.0

Gateway:

Primary DNS IP:

Secondary DNS IP:

Raw Port: 9100

Printer Name: PS-FF153C

MAC Address: 00:1B:82:FF:15:3C

EAP Type:

Username:

Password:

File Name Browse

CA Certificate:

Client Certificate:

Private Key:

EAP-FAST PAC:

Wi-Fi Version: 3.7.1.0R6

RSSI: 0

Set Get

For WPA-Enterprise

- I. Fill-in the **SSID**.
- II. Select the Encryption option to **WPA2-Enterprise**.
- III. Select DHCP to **ON** (For **OFF** option, please fill-in the IP Address, Subnet Mask and Gateway)
- IV. Select the **EAP Type** option. (For **EAP-TLS** option, please upload the CA and Key for mutual authentication, integrity-protected cipher suite negotiation, and key exchange between two endpoints.)
- V. After setting, click the **Set** button.

Note:

Before setting, the entered field will be shown in yellow for reminding.

On DHCP, user can change the printer name by another model name in "Printer Name" field.

User also can change the raw port in "Raw Port" field.

Common RS-232 Bluetooth Wi-Fi Ethernet SMTP SNTP

Built-in Wi-Fi Module

SSID: SSID_2

WLAN Encryption: WPA-Enterprise

Key: ●●●●

DHCP: ON

IP Address: 1

Subnet Mask: 0.0.0.0

Gateway:

Primary DNS IP:

Secondary DNS IP:

Raw Port: 9100

Printer Name: PS-FF153C

MAC Address: 00:1B:82:FF:15:3C

EAP Type:

Username:

Password:

File Name Browse

CA Certificate:

Client Certificate:

Private Key:

EAP-FAST PAC:

Wi-Fi Version: 3.7.1.0R6

RSSI: 0

Set Get

- After clicking **Set** button, it'll pop-up the window tip as below shown.

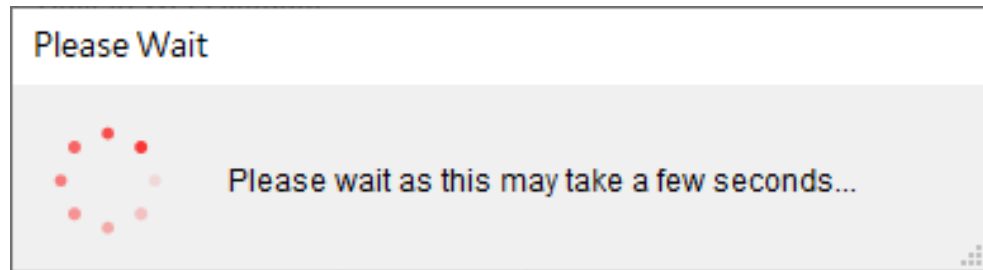

- IP address will be shown in the "IP address" field and the Wi-Fi logo and IP address will be displayed on the LCD control panel.

Note:

IP address should be shown within about 5~15 seconds after printer turn on. If not, please refer to steps below to initialize the printer Wi-Fi module settings then to setup it again.

- Remove the cable between the computer and the printer.
- Go to main page, click **Add Printer** to add the printer via **Network**.
- Select the printer and enter the setting page by double clicking the printer.
- Click the **Print Test Page** button to print the test page via Wi-Fi interface.

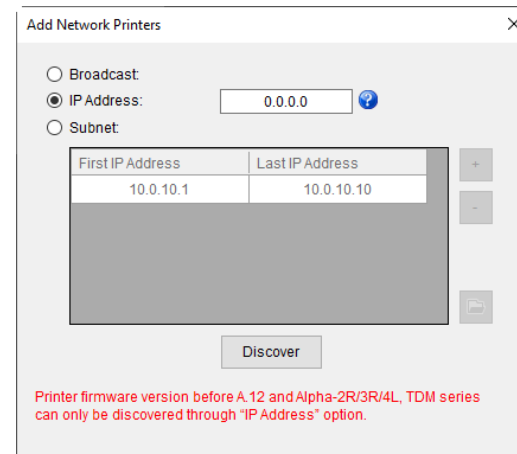

5.4 Initialize the Printer WiFi Setting

1. Return to the main page of TSC Console.

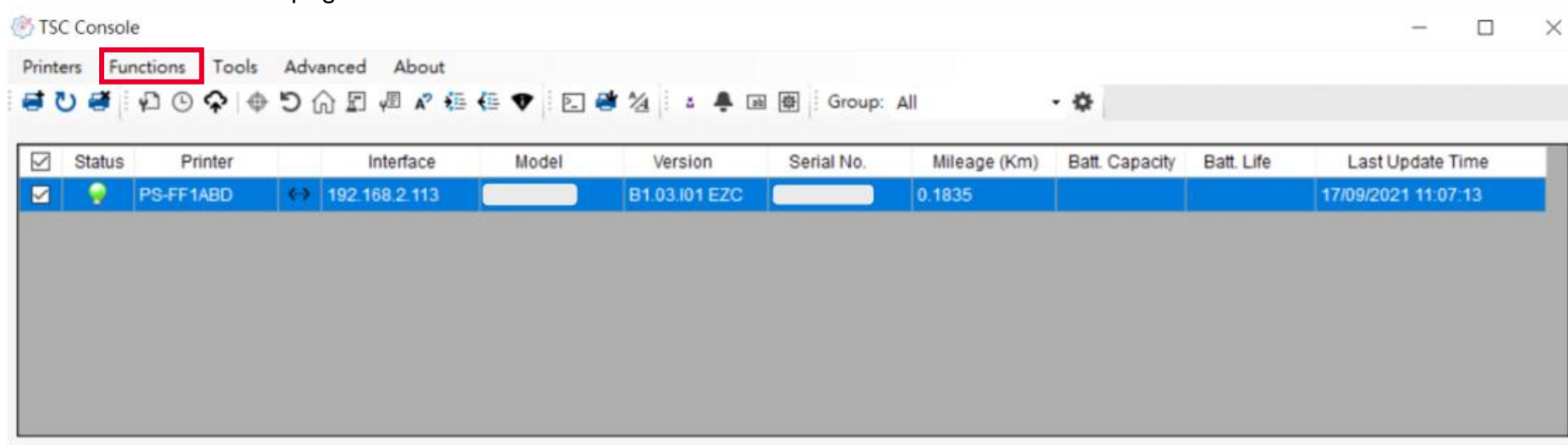

2. Click **Functions** to expand the page.
3. Click **Wi-Fi Default** to initialize the printer Wi-Fi module setting to factory default setting.

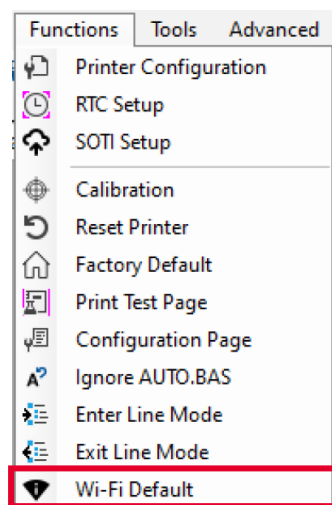

5.5 TPH Care

TPH Care provides users to check the condition of the print head and be able to set the dot failure threshold for indicating errors when the threshold is triggered.



This option is used to enable (ON)/ disable (OFF) the TPH care function.

This option is used to check the numbers of unhealthy TPH dot element.

This option is used to detect the unhealthy TPH dot.

This option is used to set the threshold for unhealthy TPH dot number.

This image is used to check the relative position of the unhealthy TPH dot.

This option is used to print a TPH test image to check the TPH printing result.

1. Enable the TPH Care function. (Note: The default is disabled/OFF.) Then click "Get TPH care profile" button and a diagram will show in the area above.
2. If the profile is flat, it means that the print head is good. Check "Unhealthy TPH dot number". If the result is zero (0), that means the print head is good.
3. Bad dots are presented as a spike in the profile. The arrow in below iprofile indicates the presence of potentially damaged dots and printer will stop printing.



5.6 Printer Function

Printer Function could be found in **Printer Configuration**. “Printer Function” will be shown on the left side of the window.



Functions	Description
Calibrate Sensor	Detect media types and the size of the label
RTC Setup	Synchronize printer with Real Time Clock on PC
Factory Default	Initialize the printer to default settings
Reset Printer	Reboot printer
Print Test Page	Print test page according to the specified label size and sensor type.
Configuration Page	Print printer configurations
Dump Text	Activate the printer to dump mode
Ignore AUTO.BAS	Ignore AUTO.BAS file when printer boot up.
Exit Line Mode	Exit the line mode to page mode
Enter Line Mode	Leave page mode and enter line mode
Reset WiFi	Restore the WiFi settings to defaults.

5.7 Setting Post-Print Action

When the printer is equipped with other option kits, ex: cutter, peeler, rewinder, please select the mode after finishing the calibration.

Follow below procedure to set the post action for the printing:

Refer Chp 5.1 to Connect the printer with **TSC Console** > **Double click** the printer > The **Printer Configuration Page** will pop up > Click **Get** to load information > Go to **Common Tab** > Find **Post-Print Action** > **Select the mode** depends on users' application > Click **Set**.

Printer Configuration

Printer Configuration Emulation TPH Care Smart Battery Unit: mm

Printer Function

Calibration

RTC Setup

Factory Default

Reset Printer

Print Test Page

Configuration Page

Dump Text

Ignore AUTO.BAS

Exit Line Mode

Enter Line Mode

Wi-Fi Default

Get Status

Save Load

Printer Configuration

Version: []

Serial No.: [] TPH Serial Number: N/A

Checksum: 1344B9B1 TPH Odometer: N/A

Ribbon Remaining: [] % Cutter Serial Number: N/A

Label Count: 553

Cutting Counter: 0 0 Reset

Mileage (Km): 0.0913 0.0913 Reset

Common RS-232 Bluetooth Wi-Fi Ethernet SMTP SNTP

Speed: 3 Ribbon: OFF

Density: 8 Ribbon Sensor: OFF

Paper Width: 104.00 mm Ribbon Encoder Err.: OFF

Paper Height: 74.05 mm Head-up Sensor: ON

Media Sensor: Black Mark Reprint After Error: ON

Gap: 1.99 0.00 mm Maximum Length: 152.25 mm

Post-Print Action: [] Gap Inten.: 7

Reference: OFF Bline Inten.: 7

Direction: TEAR Continuous Inten.: 4

Offset: PEEL Threshold Detection: AUTO

Shift X: CUTTER Print Quality: STANDARD

Shift Y: REWIND Standby Time: 120 secs

Code Page: 850 Sleep Time: 0 mins

Country Code: 001 (1~65534, 0: OFF)

(10~65534, 0: OFF)



3 Set 1 Get

6. LCD Menu Function

6.1 Enter the Menu

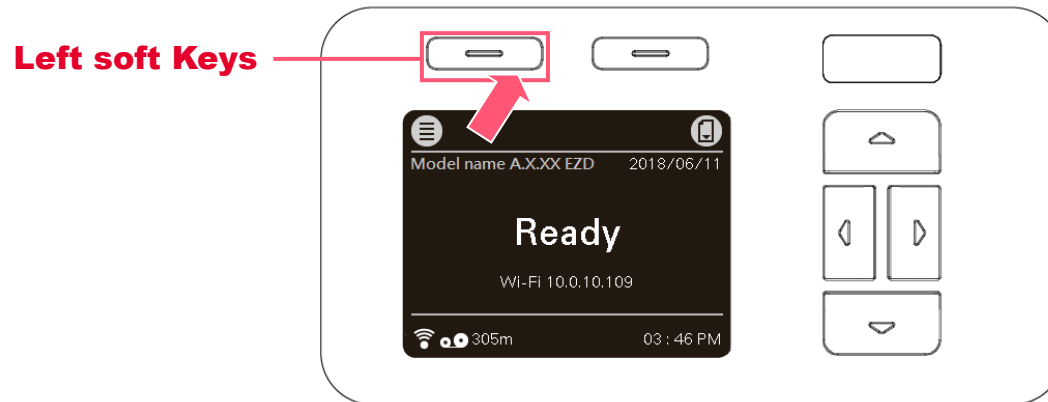
1. Press the left side soft key (means ) to enter the "Menu".



2. Use the navigational keys to select the icon (be marked in green) and press the right soft key (means ) to enter the selected item. Press left soft key (means ) to return to previous page.

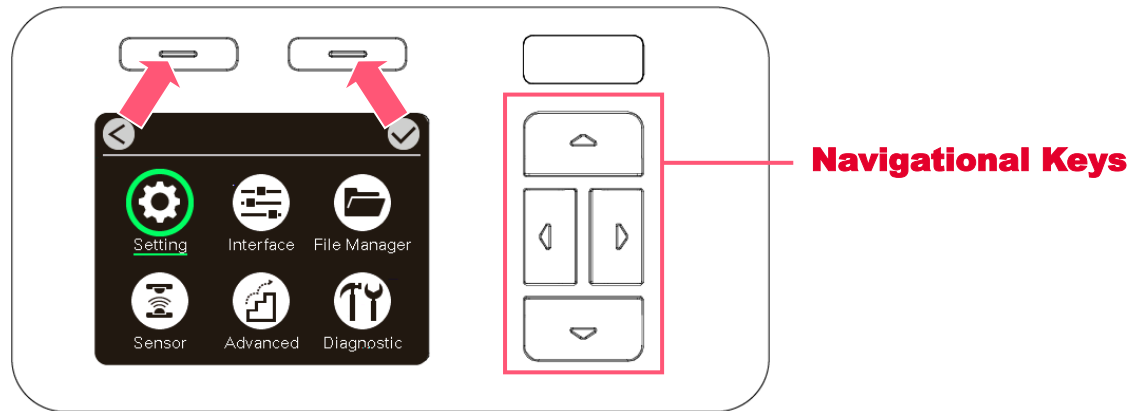

6.2 Menu Overview

There are 6 categories on the menu. Users can easily set the settings of the printer without connecting the computer. Please refer to following sections for more details.



Setting : To set up the printer settings for TSPL & ZPL2.



Advanced : To set LCD, initialization, cutter type,...etc.



Sensor : To calibrate the selected media sensor.



File Manager : To check and manage printer's memory storage.

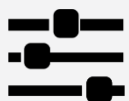

Interface : To set the printer interface settings.



Diagnostic : To check printer and help users to troubleshoot the problems.

6.3 Setting

Press the right soft key to switch the TSPL, ZPL2, and SBPL. Select the item by navigational key and press right soft key to enter the selected item.

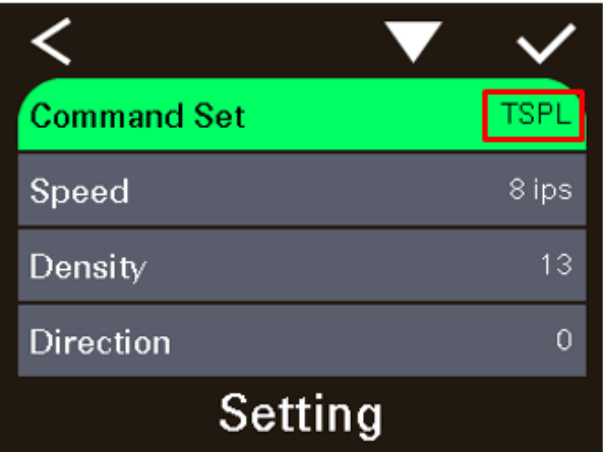

6.3.1 TSPL

TSPL category can set up the printer settings for TSPL.

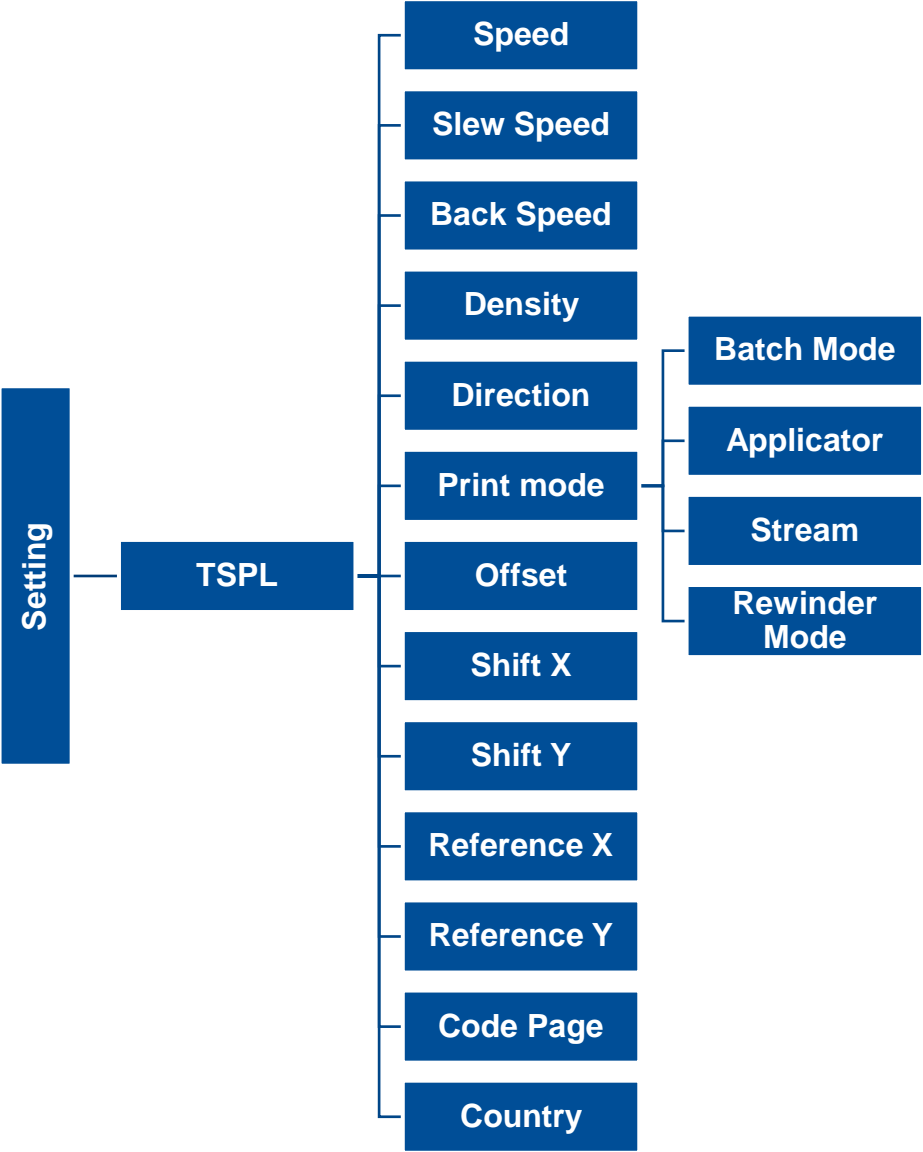

Item	Description	Default
Speed	Set the print speed. Setting range: 2~18 for 203dpi; 2~14for 300dpi; 1.5~6 for 600dpi	203 dpi: 6 300 dpi: 4 600 dpi: 3
Slew Speed	Set feed speed	203 dpi: 6 300 dpi: 4
Back Speed	Set back speed	2
Density	Set printing darkness. Setting range: 0 to 15, and the step is 1.	8
Direction	Set the printout direction. Setting Value: 0 and 1. Direction 0: <input type="text" value="Direction"/> Direction 1: <input type="text" value="Direction"/>	0
Print mode	Set the print mode. There are 4 modes in total: Batch Mode: Once finishing the printing process, label will be fed to the tear plate location. Applicator: The printer prints a label when it receives a signal from the applicator. Stream:: The print engine prints a batch of labels with backfeed occurring only at the start and end of the batch instead of between individual labels. Rewinder Mode: Enable the label rewinder mode.	Batch Mode
Offset	Adjust media stop location. Available value setting range: -999 dots to 999 dots.	0 dot
Shift X	Adjust print position. Available value setting range: -999 dots to 999 dots.	0 dot
Shift Y		0 dot
Reference X	Set the origin of printer coordinate system horizontally and vertically. Available setting range: 0 dot to 999 dots.	0 dot
Reference Y		0 dot
Code page	Set the code page of international character set.	850
Country	Set the country code. Available setting value range: 1 to 358.	001

Note: If printing from enclosed software/driver, the software/driver will send out the commands, which will overwrite the settings set from the panel.

6.3.2 ZPL2

This "ZPL2" category can set up the printer settings for ZPL2.

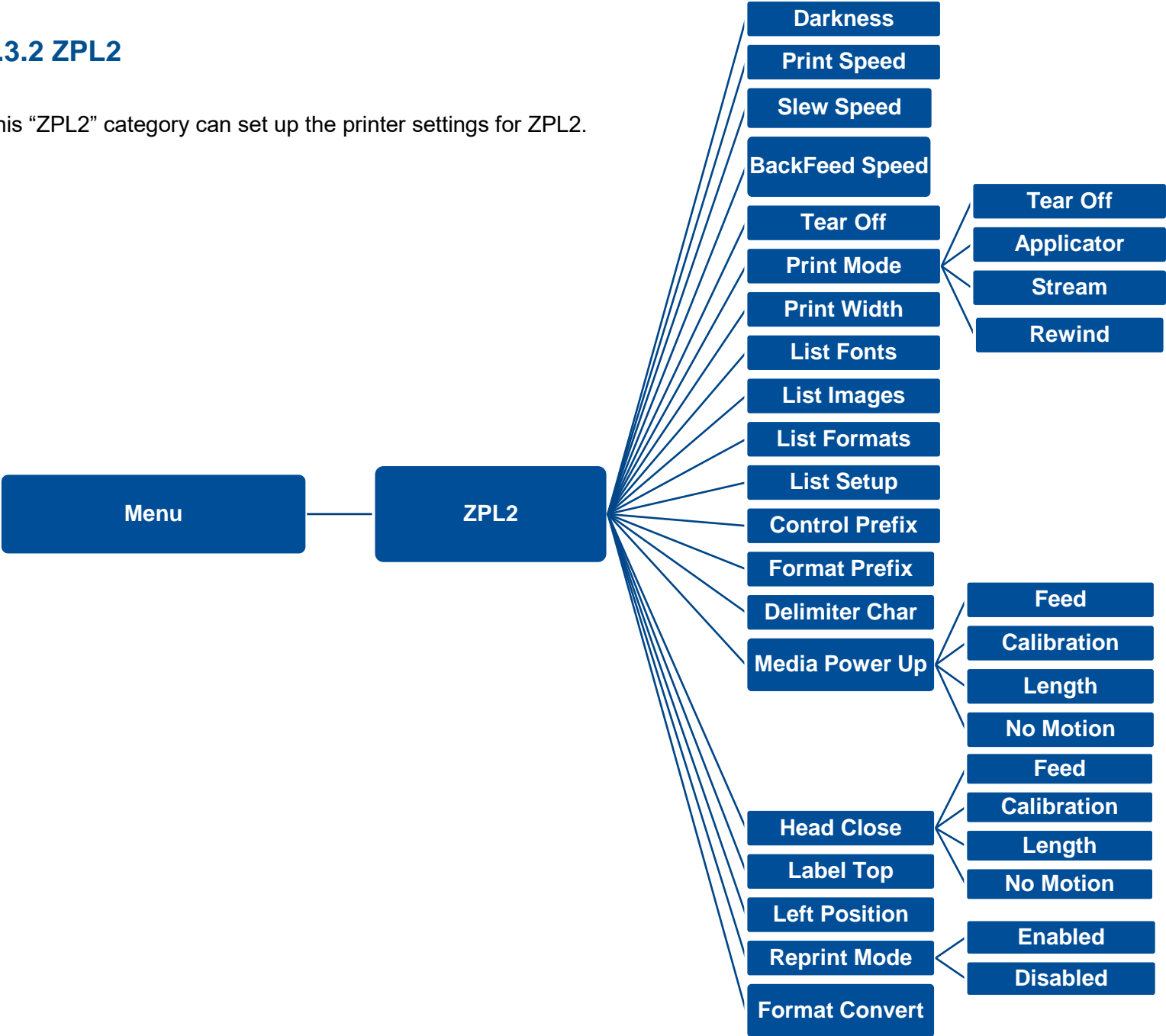

Item	Description	Default
Density	Set the printing darkness. Available setting range: 0 to 30.	16
Print Speed	Set the print speed. Available setting range is 2~18 for 203dpi and 2~14 for 300dpi; 1.5~6 for 300dpi..	203 dpi: 6 300 dpi: 4 600 dpi: 3
Slew Speed	Set feed speed	203 dpi: 6 300 dpi: 4
BackFeed Speed	Set back speed	2
Tear Off	Adjust media stop location. Available setting value range: -120~120 dots. Set the print mode. There are 4 modes in total:	0 dot
Print mode	<p>Tear Off: Once finishing the printing process, label will be fed to the tear plate location.</p> <p>Applicator: The printer prints a label when it receives a signal from the applicator.</p> <p>Stream: The print engine prints a batch of labels with backfeed occurring only at the start and end of the batch instead of between individual labels.</p> <p>Rewind: Enable the label rewinder mode.</p>	Tear Off
Print Width	Set the print width. Available setting range: 2 ~ 999 dots.	812
List Fonts	Print the current fonts list from the memory devices to the label.	N/A
List Images	Print current printer available images list stored at the memory device to the label.	N/A
List Formats	Print current printer available formats list from the memory devices to the label.	N/A
List Setup	Print current printer configuration to the label.	N/A
Control Prefix	Set control prefix character.	N/A
Format Prefix	Set format prefix character.	N/A
Delimiter Char	Set delimiter character.	N/A

Media Power Up	Set the action of the media when turning on the printer.	
	Feed: Printer will advance one label.	
	Calibration: Printer will make calibration.	No Motion
	Length: Printer determine length and feed label.	
Head Close	Set the action of the media when closing the print head.	
	Feed: Printer will advance one label.	
	Calibration: Printer will make calibration.	No Motion
	Length: Printer determine length and feed label.	
No Motion: Printer will not move media.		
Label Top	Adjust print position vertically on the label. Value range: -120 to +120 dots.	0
Left Position	Adjust print position horizontally on the label. Value range:-9999 to +9999 dots.	0
Reprint Mode	Reprint the last label by pressing  button on printer's control panel.	Disabled
Format Convert	Select the bitmap scaling factor. The first number is the original dots per inch (dpi) value; the second the dpi which you would like to scale.	None

Note: printing from other software/drive will overwrite the settings set from the panel.

6.3.1 SBPL (Only available on EZS version firmware)

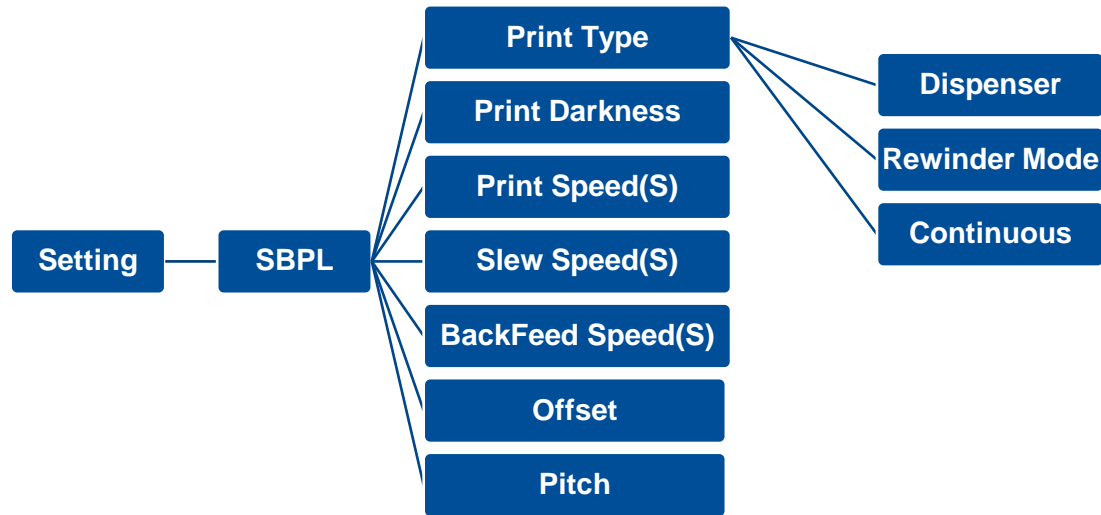

Item	Description	Default
Print Type	This item is used to set the print mode. There are three modes as below, Dispenser Once printer complete printing 1 label, it will wait for being removed. Rewinder mode The print engine prints without pausing between labels. The media is wound onto a core after printing. Continuous Print the specified number of media	Dispenser
Print Darkness	Use this item to setup printing darkness. The available setting range is from 0 to 10. You may need to adjust your density based on selected media.	3
Print Speed	Use this item to setup print speed. Available setting range is 2~18 for 203dpi, 2~14 for 300dpi and 1.5 ~6 for 600dpi.	203 dpi: 6 ips 300 dpi: 4 ips 600 dpi: 3 ips
Slew Speed	Use this item to setup feed speed. Setting value is up to 8 ips.	203 dpi: 6 ips 300 dpi: 4 ips 600 dpi: 3 ips
BackFeed Speed	Use this item to setup back feed speed. Setting value is up to 6 ips.	2 ips
Offset	Adjust offset position	0 dot
Pitch	Adjust print position	0 dot

6.4 Sensor

This option is used to calibrate the selected sensor. We recommend calibrate the sensor before printing when changing the media.

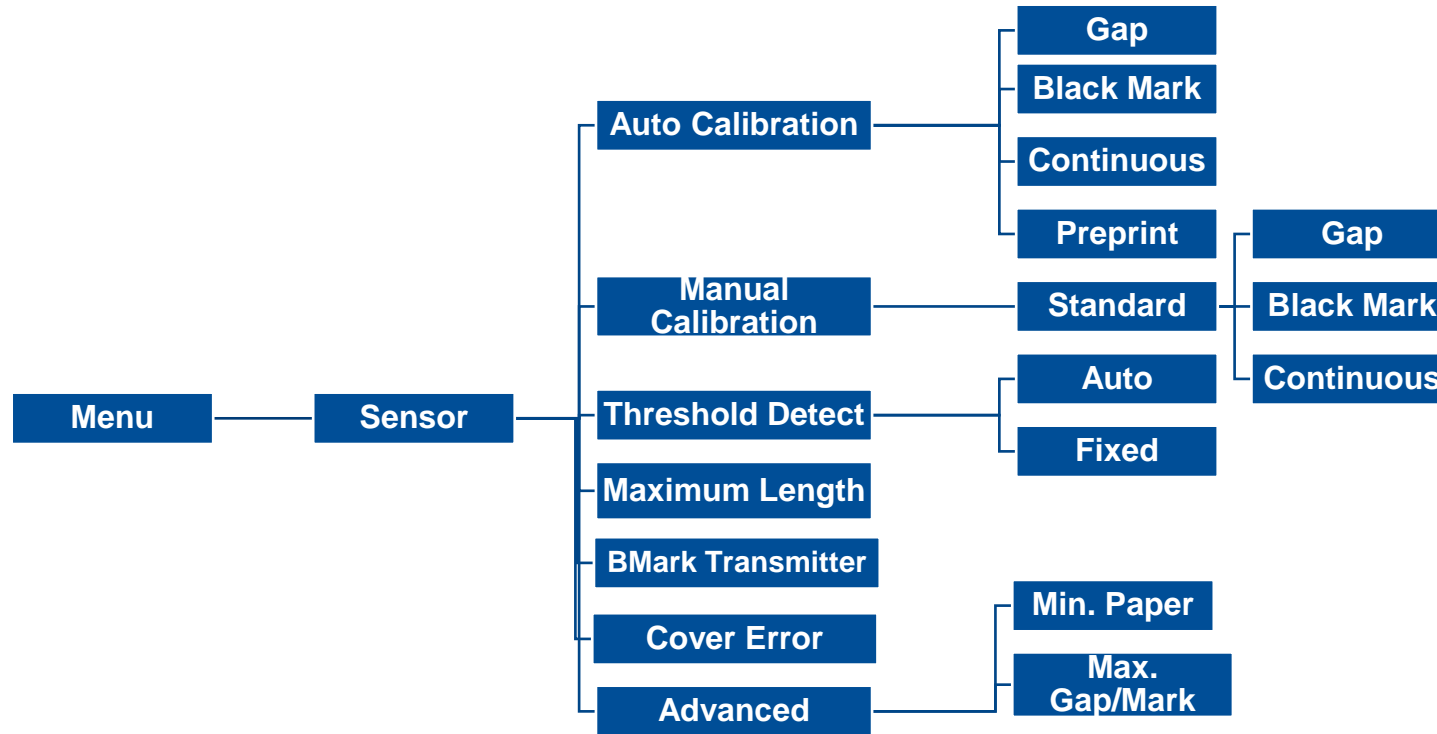

Item	Description	Default
Auto Calibration	Set the media sensor type and calibrate the selected sensor automatically.	N/A
Manual Calibration	In case Auto Calibration does not work, please use “Manual” function to set the paper length and gap/bline size to complete the calibration setting.	N/A
Threshold Detect	Set sensor sensitivity in fixed or auto.	Auto
Maximum Length	Set the maximum length for label calibration.	254 mm
BMark Transmitter	This option is used to set upper or lower black mark sensor as the main transmitter.	Back side
Cover Error	Enable pop up the error when opening the media cover	Disable
Advanced	Set the minimum paper length and maximum gap/bline length for auto-calibration.	0 mm

6.5 Interface

Interface can set the printer interface settings.

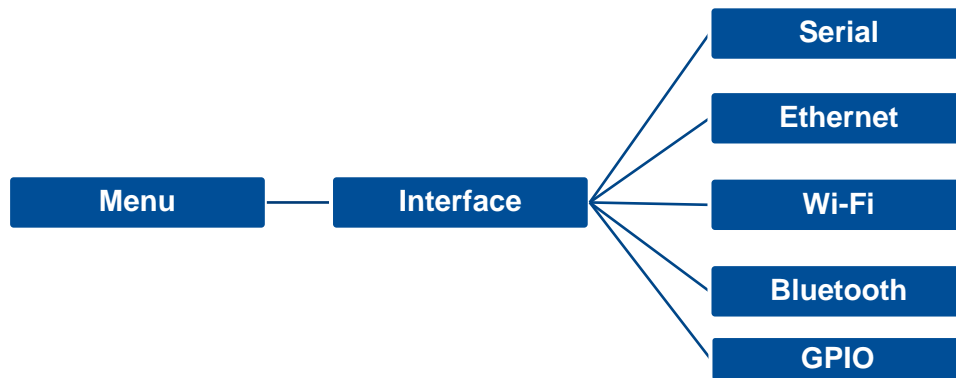

6.5.1 Serial Comm

Serial comm can set the printer RS-232 settings.

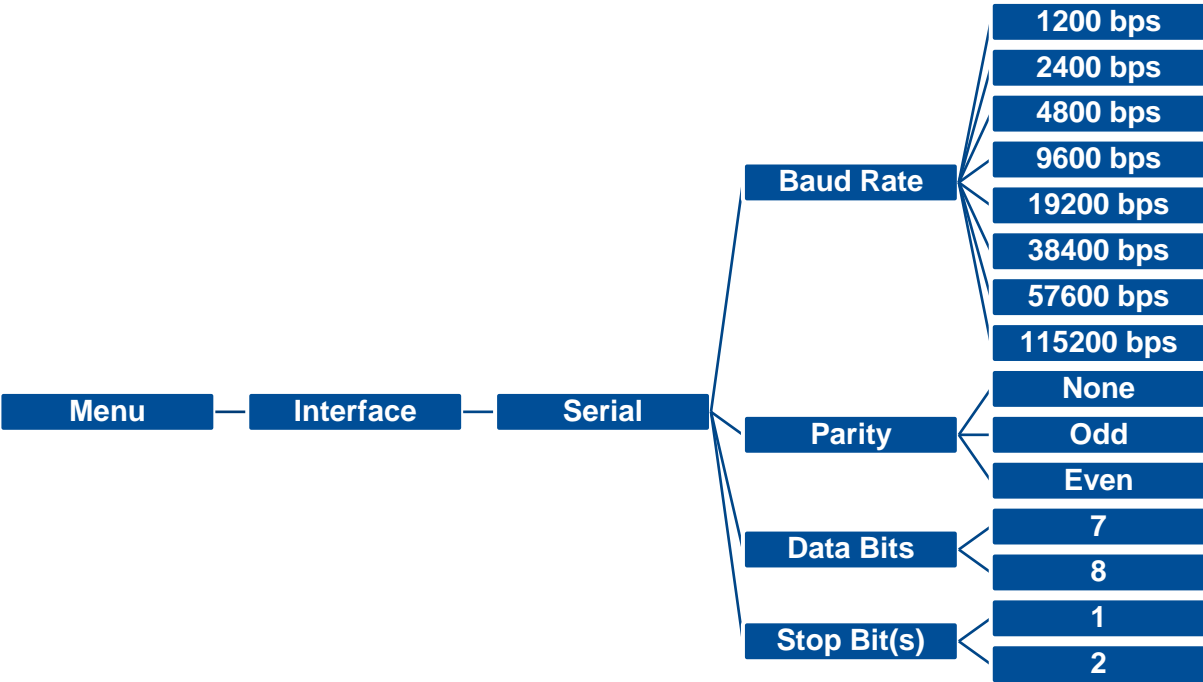

Item	Description	Default
Baud Rate	Set the RS-232 baud rate.	9600
Parity	Set the RS-232 parity.	None
Data Bits	Set the RS-232 Data Bits.	8
Stop Bit(s)	Set RS-232 Stop Bits.	1

6.5.2 Ethernet

Ethernet configures internal Ethernet configuration and checks the printer's Ethernet module status, and reset the Ethernet module.

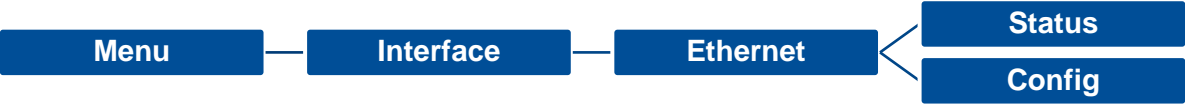

Item	Description	Default
Status	Check the Ethernet IP address and MAC setting status.	N/A
Config.	DHCP: On or OFF the DHCP (Dynamic Host Configuration Protocol) network protocol. Static IP: Use this menu to set the printer's IP address, subnet mask and gateway.	DHCP

6.5.3 Wi-Fi

Wi-Fi can set the printer Wi-Fi settings.

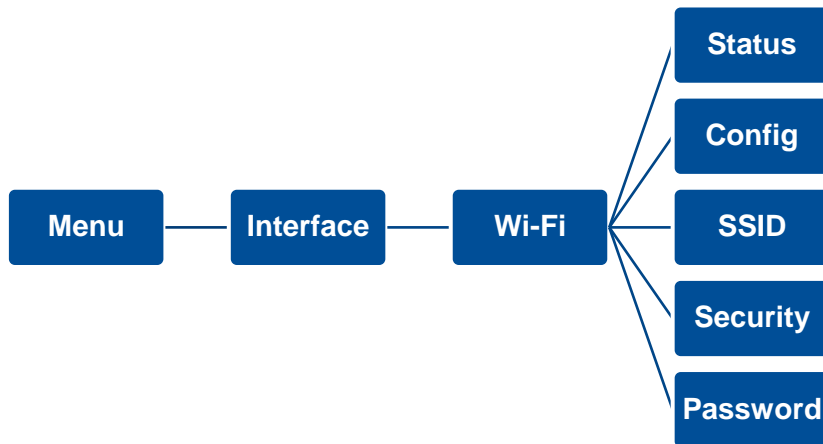

Item	Description	Default
Status	Check the Wi-Fi IP address, MAC setting status,...etc.	N/A
Config.	DHCP: ON/OFF the DHCP (Dynamic Host Configuration Protocol) network protocol. Static IP: Set the printer's IP address, subnet mask and gateway.	DHCP
SSID	Set Wi-Fi SSID.	N/A
Security	Set Wi-Fi security.	Open
Password	Set Wi-Fi password.	N/A

6.5.4 Bluetooth

Bluetooth can set the printer Bluetooth settings.

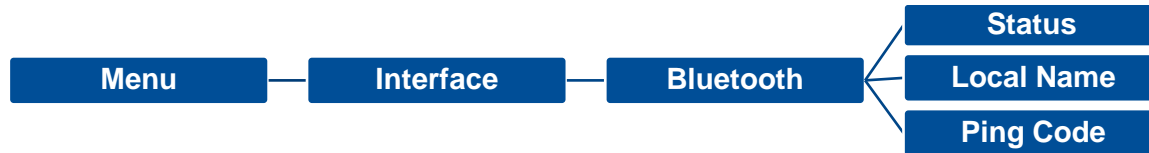

Item	Description	Default
Status	Check the Bluetooth status.	N/A
Local Name	Set the local name for Bluetooth.	RF-BHS
Ping Code	Set the local ping code for Bluetooth.	0000

6.5.5 GPIO

This option is used to set the print engine GPIO settings. (Applicator interface with DB15F connector +5V I/O)

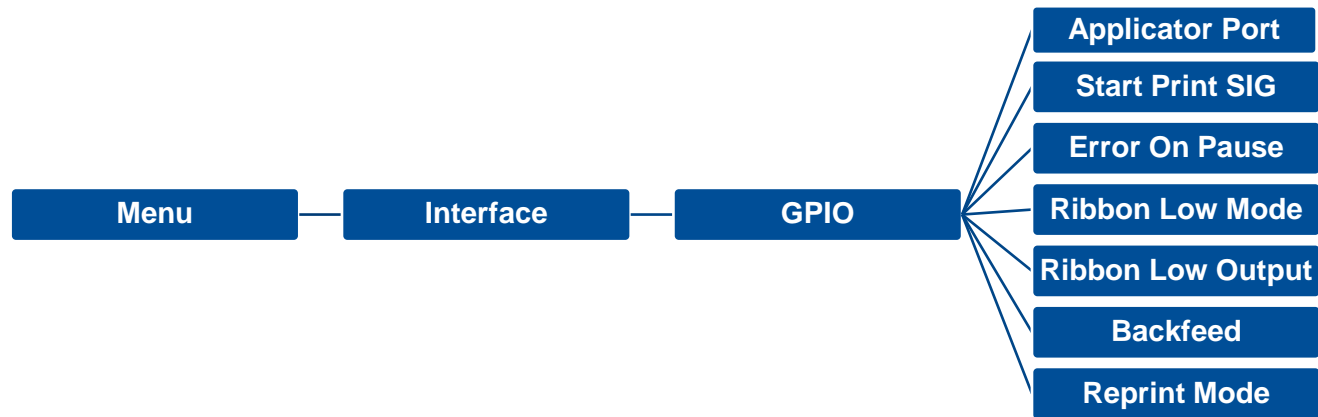

Item

Description

Default

This option is used to set the GPO_3 signal when PRINT END.









Applicator Port

Mode 1



Off

Selections	Description						
Off	The applicator port is off.						
Mode 1		Label format sent	Label format processed	Waiting for start print signal	Label prints	Ready for next label	
	Data ready (Pin 14, GPO_6)						Not ready Ready
	Print start (Pin 3, GPI_1)						Do not start Start
	Print End (Pin 11, GPO_3)						Do not end End

Mode 2

	Label format sent	Label format processed	Waiting for start print signal	Label prints	Ready for next label	
Data ready (Pin 14, GPO_6)						
Print start (Pin 3, GPI_1)						
Print End (Pin 11, GPO_3)						

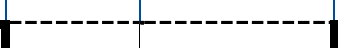
Mode 3

	Label format sent	Label format processed	Waiting for start print signal	Label prints	Ready for next label	
Data ready (Pin 14, GPO_6)						

Print start (Pin 3, GPI_1)		Do not start Start
Print End (Pin 11, GPO_3)		Do not end End

Mode 4

	Label format sent	Label format processed	Waiting for start print signal	Label prints	Ready for next label	
Data ready (Pin 14, GPO_6)						Not ready Ready
Print start (Pin 3, GPI_1)						Do not start Start
Print End (Pin 11, GPO_3)						Do not End End

	Customized	Use GPIO setting commands for customized settings. For GPIO command, please refer to TSPL/TSPL2 programming manual.	
Start Print SIG		This determines the trigger conditions for the printer to control GPI 1 and GPI4.	Level mode
Error On Pause		When this option is enabled and the printer is paused, the error signal (GPO_2) is LOW.	Enable
Ribbon Low Mode		When this option is enabled and the printer is Low Ribbon (GPO_1), the printer will generate a warning.	Enable
Ribbon Low Output		When the Ribbon Low Mode feature is enabled, this parameter determines if the output signal on Pin 9 (GPO_1) is HIGH or LOW.	Active High
Backfeed		This determines the timing of pullback.	Default
Reprint Mode		When this option is disabled, the printer reprint function (GPI_4) will be invalid.	Disable

6.5.6 GPIO-DB25 (Only available on EZS Version firmware)

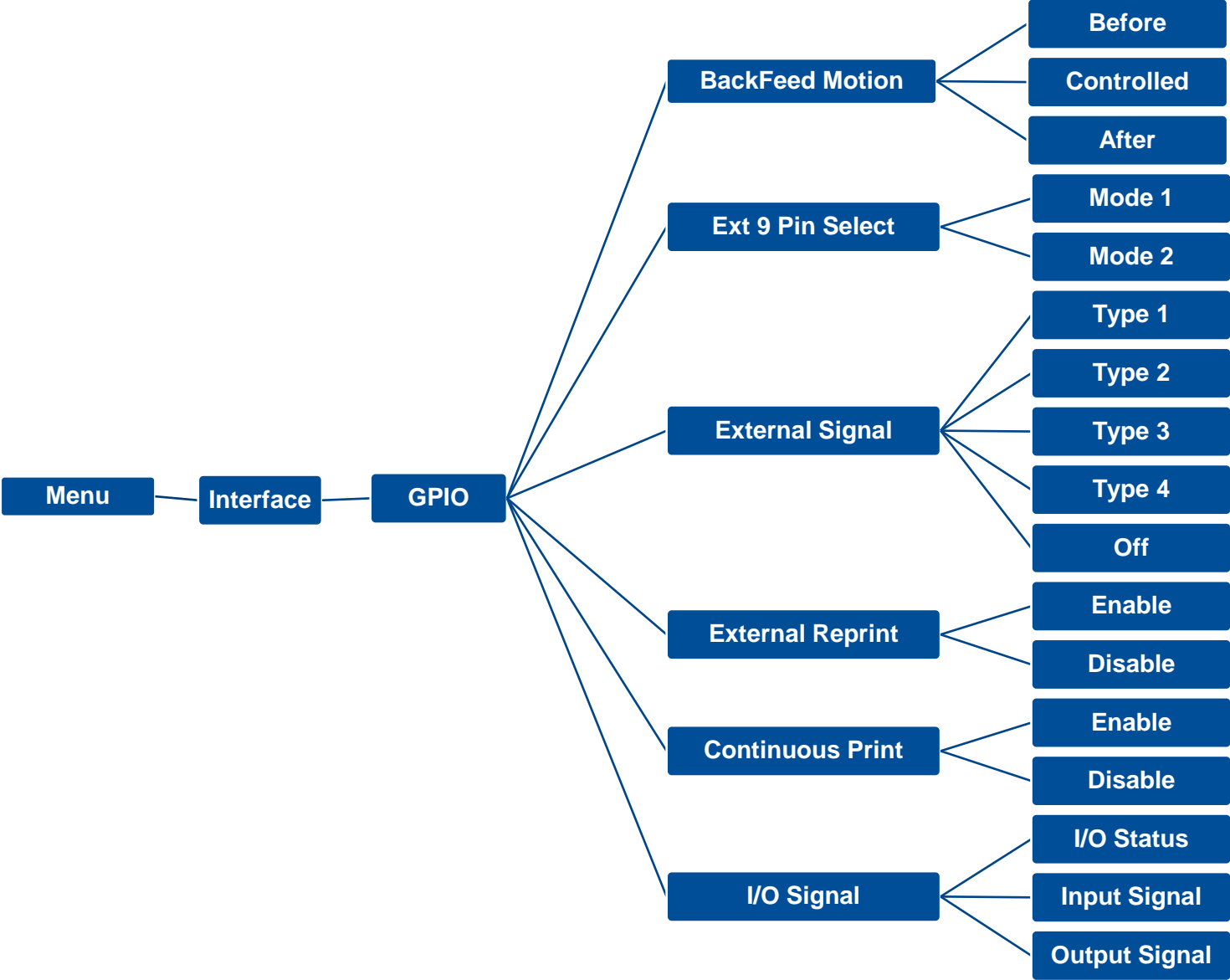

Item	Description	Default
BackFeed Motion	Set the Backfeed motion in dispenser mode BEFORE: Backfeed the media to the print head position before printing AFTER: Backfeed the label after dispensing CONTROLLED: Backfeed motion will be controlled by external signal	Before
Ext 9 Pin Select	Set the output mode of the external signal pin 6 when using a 25-pin connector MODE1: Outputs the signal when the product has/does not have remaining print data. MODE2: Outputs the signal if the product is in online or offline mode. (offline Is ERROR status)	Mode 1
External Signal	Enable or disable the external signal function OFF: Disable the external signal function TYPE 1: The Print End signal is High before label printing, and it becomes Low after print completion. The signal level becomes High after 20 msec. TYPE 2: The Print End signal is Low before label printing, and it becomes High after print completion. The signal level becomes Low after 20 msec. TYPE 3: The Print End signal is High before label printing, and it becomes Low from the start to the end of print, and it becomes High again after print completion TYPE 4: The Print End signal is Low before label printing, and it becomes High from the start to the end of print, and it becomes Low again after print completion	Off

Type 1,2

First label complete

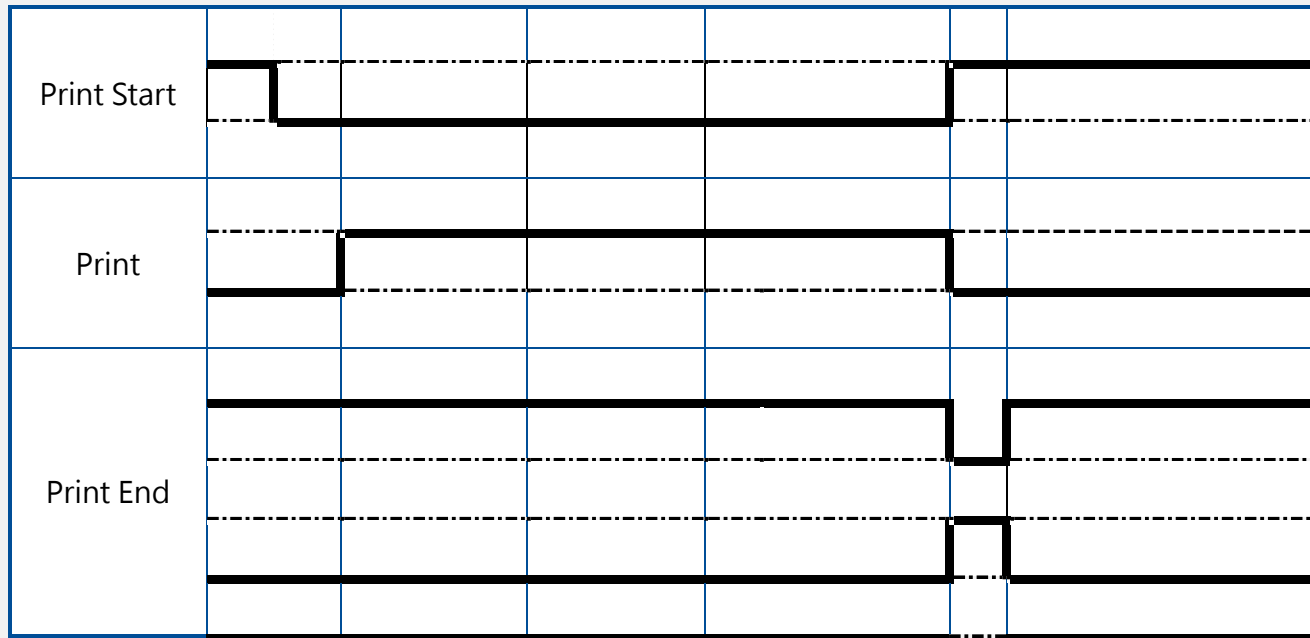

Type 3,4

First label complete

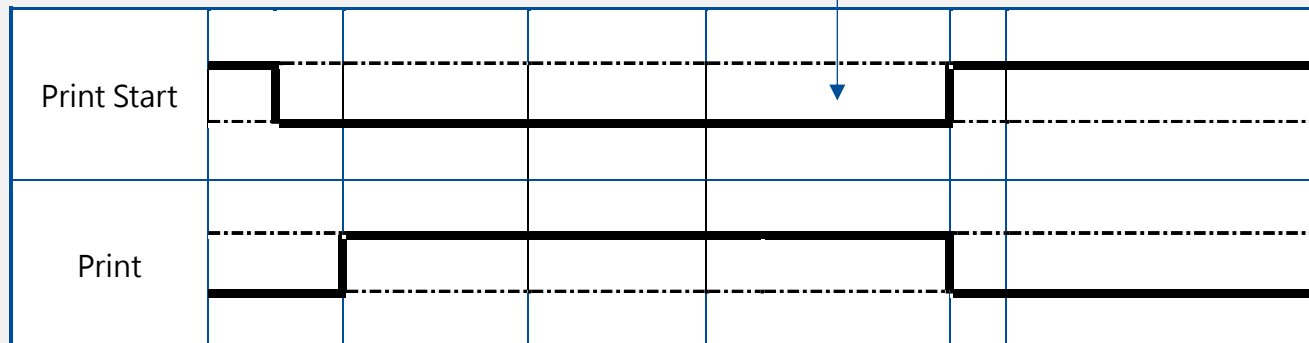

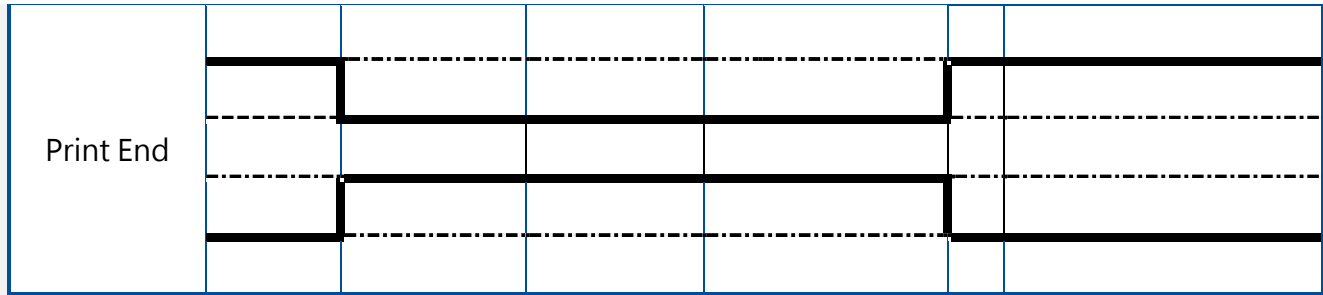

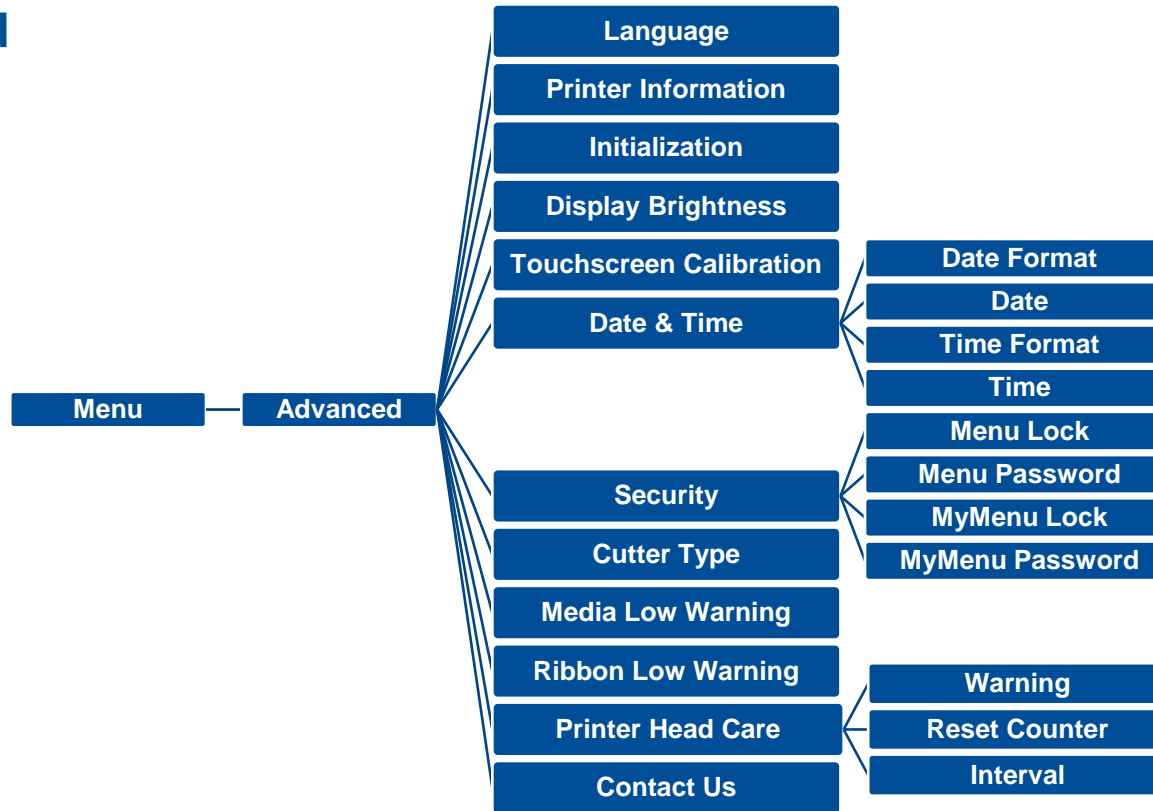

External Reprint	Use external signal to trigger the reprint signal to access reprint function ENABLE: Enable the reprint DISABLE: Disable the reprint	Disable
Continuous Print	Use external signal to trigger the Print start signal to access reprint function ENABLE: Enable the continuous print DISABLE: Disable the continuous print	Disable
I/O Signal	Check the I/O Signal status and set the input and output pin settings Input signal: Set the Print Start Pin Output signal: Set the Print End Pin	-

6.6 Advanced



Item	Description	Default
Language	Switch the language on display.	English
Printer Information	Check the printer's serial number, printed mileage (m), printed labels (pcs) and cutting counter.	N/A
Initialization	Restore printer settings to defaults.	N/A
Display Brightness	Set the brightness for display. Range: 0~100.	50
Touchscreen Calibration	Calibrate the touchscreen for best result.	N/A

Date & Time	Setup the date and time on display.	N/A
Security	Set the password for locking the menu or favorites. The default password is 8888.	Disable
Cutter Type	Set the cutter type.	Guillotine
Media Low Warning	Set the warning for media low %. if setting value is 10%, media capacity was lower than 10%, the  % will be shown in red.	10%
Ribbon Low Warning	Set the warning for ribbon low. For example, if setting value is 30m, when ribbon capacity was lower than 30m, the  will be shown in red.	30M
Printer Head Maintn	<p>Check print head status and to set the settings for print head care.</p> <p>Warning: Enable/disable the print head clean warning. If enable this feature, once print head has been reached the setting mileage then the warning icon will be shown on printer UI for reminding user to clean the print head. The default setting is disable.</p> <p>Reset Counter: Reset the print head clean warning mileage after cleaning print head.</p> <p>Interval: This item is used to set the expected mileage for reminding user to clean the print head. You have to enable the “TPH warning lock” for use. The default setting is 1 km.</p> <p>Key sound: This item is used to enable/disable the sound of front panel buttons.</p>	N/A
Contact us	Check the contact information for tech support service	N/A

6.7 File Manager

File Manager is used to check the printer available memory, show the files list, delete the files or run the files that saved in the printer DRAM/Flash/Card memory.



6.8 Diagnostic

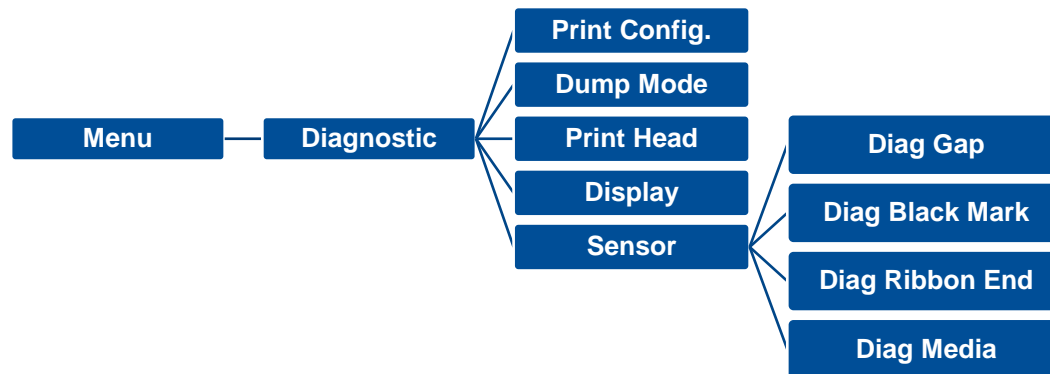

```

DOWNLOA 0D 0A 44 4F 57 4E 4C 4F 4I
D „TEST2. 44 20 22 54 45 53 54 32 2E
DAT“,5,CL 44 41 54 22 2C 35 2C 43 4C
S DOWNLO 53 0D 0A 44 4F 57 4E 4C 4F
AD F,“TES 41 44 20 46 2C 22 54 45 53
T4.DAT“,5 54 34 2E 44 41 54 22 2C 35
,CLS DOW 2C 43 4C 53 0D 0A 44 4F 57
NLOAD „TE 4E 4C 4F 41 44 20 22 54 45
ST2.DAT“, 53 54 32 2E 44 41 54 22 2C
5,CLS DO 35 2C 43 4C 53 0D 0A 44 4F
WNLOAD F, 57 4E 4C 4F 41 44 20 46 2C
„TEST4.DA 22 54 45 53 54 34 2E 44 41
T“,5,CLS 54 22 2C 35 2C 43 4C 53 0D
DOWNLOAD 0A 44 4F 57 4E 4C 4F 41 44
“TEST2.D 20 22 54 45 53 54 32 2E 44
AT“,5,CLS 41 54 22 2C 35 2C 43 4C 53
DOWNLOA 0D 0A 44 4F 57 4E 4C 4F 4I
D F,“TEST 44 20 46 2C 22 54 45 53 54
4.DAT“,5, 34 2E 44 41 54 22 2C 35 2C
CLS 43 4C 53 0D 0A
  
```

Item

Description

Print Config.

Print current printer configuration to the label. The configuration printout contains print head test pattern, which is useful for checking the dot damage on the print head heater.

Dump Mode

Captures the data from the communications port and prints out the data received by printer. In the dump mode, all characters will be printed in 2 columns. The left side characters are received from your system and right side data are the corresponding hexadecimal value of the characters. It allows users or engineers to verify and debug the program.

Dump mode requires 4" width paper.

Print Head

Check print head's temperature and bad dots.

Display

Check LCD's color state.

Sensor

Check sensors intensity and reading state.

6.9 Favorites

This feature can create customized menu list. You can organize the commonly used setting options to the Favorites list.

Enter Favorites List

1. Press and hold the left side soft key on Ready mode to enter **Favorites**. (Default: No items in the list)

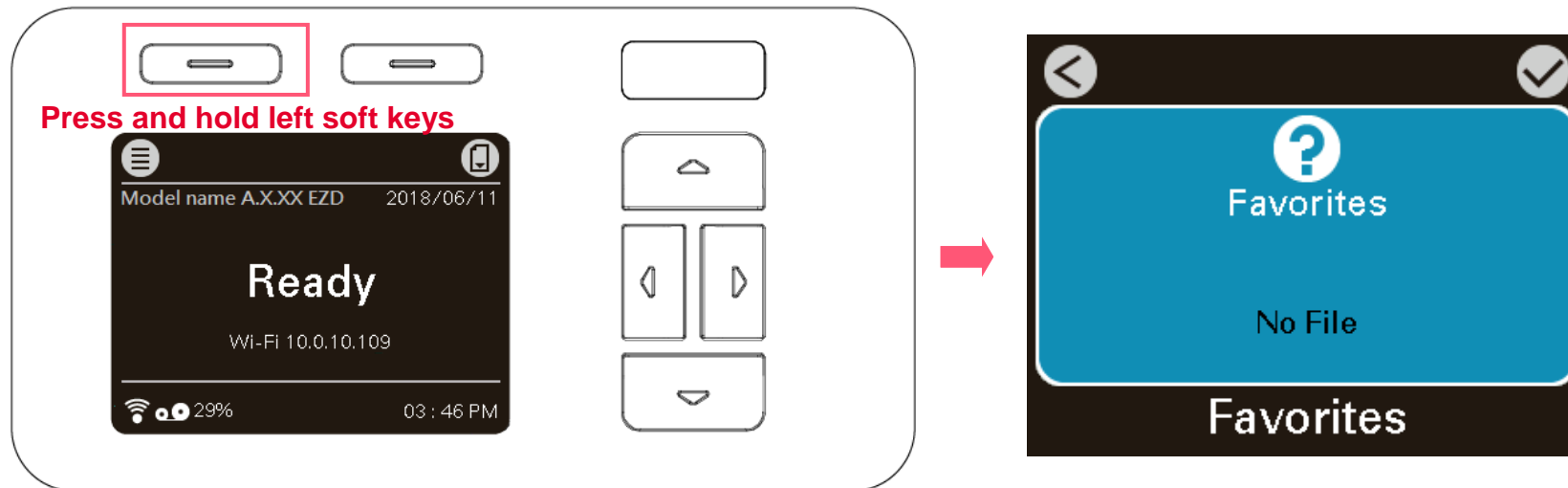

Add List to Favorite

1. Select one option item, and press and hold the right soft key until **Join Favorites** window pops up. Select “Yes” to add the item to Favorites list.

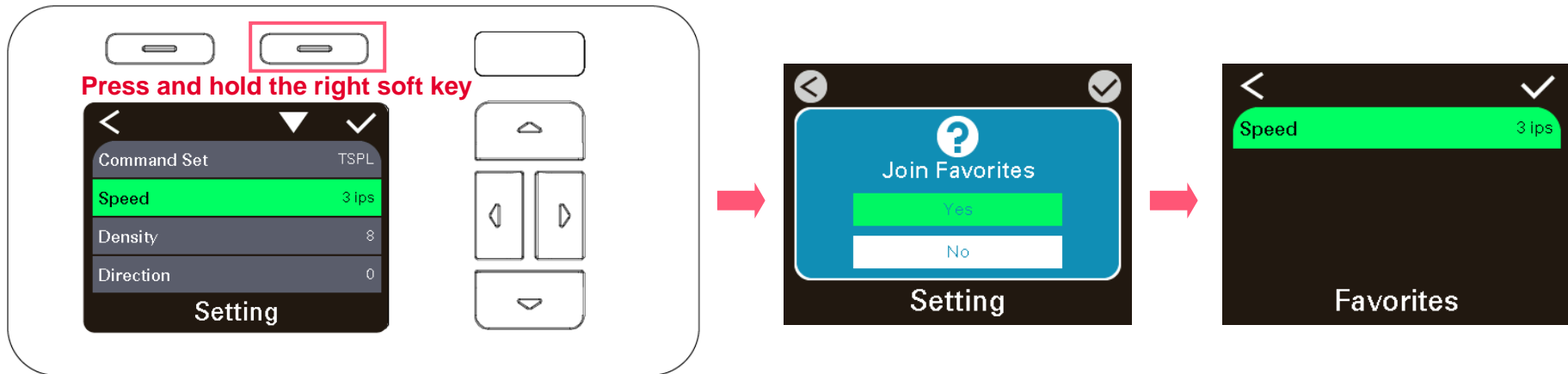

Delete Items From Favorite

2. Select one option item, and press and hold the right soft key until **Delete Favorites** window pops up. Select “Yes” to remove the item from Favorites list.

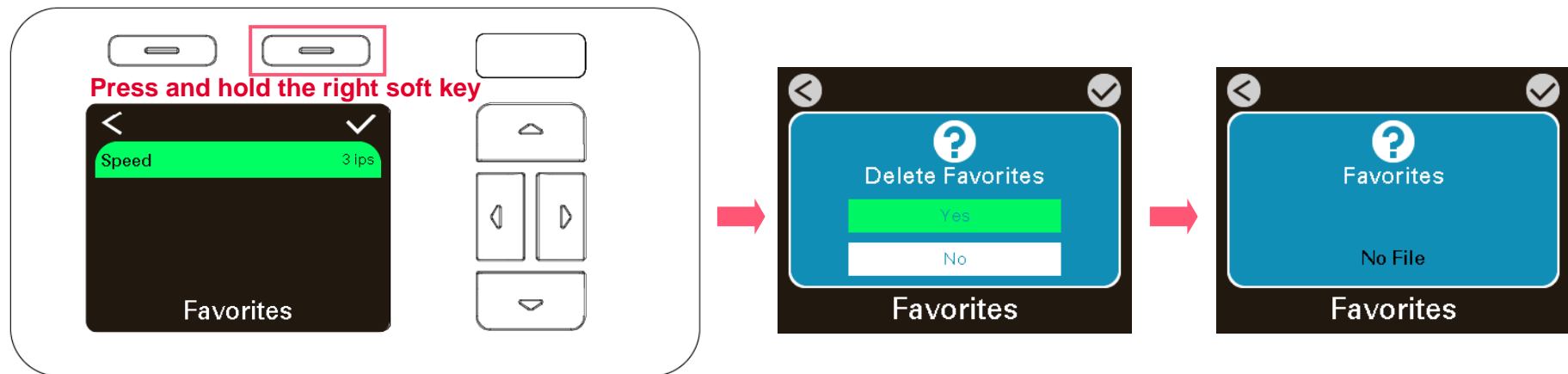

7. Troubleshooting

Problem	Possible Cause	Recovery Procedure
Power indicator does not illuminate Carriage Open	<ul style="list-style-type: none"> * The power cord is not properly connected. * The print head carriages are open. 	<ul style="list-style-type: none"> * Plug the power cord in print engine and outlet. * Switch the power on. * Please close the print carriages.
Not Printing	<ul style="list-style-type: none"> * Check if interface cable is well connected to the interface connector. * Check if wireless or Bluetooth device is well connected between host and print engine. * The port specified in the Windows driver is not correct. 	<ul style="list-style-type: none"> * Re-connect cable to interface or change a new cable. * Please reset the wireless device setting. * Select the correct print port in the driver. * Clean the printhead. * Printhead's harness connector is not well connected with printhead. Turn off the power and plug the connector again. * Check your program if there is a command PRINT at the end of the file and there must have CRLF at the end of each command line.
No print on the label	<ul style="list-style-type: none"> * Label or ribbon is loaded not correctly. * Use wrong type paper or ribbon 	<ul style="list-style-type: none"> * Follow the instructions in loading the media and ribbon. * Ribbon and media are not compatible. * Verify the ribbon-inked side. * The print density setting is incorrect.
No Ribbon	<ul style="list-style-type: none"> * Running out of ribbon. * The ribbon is installed incorrectly. 	<ul style="list-style-type: none"> * Supply a new ribbon roll. * Please refer to the steps in user's manual to reinstall the ribbon.
No Paper	<ul style="list-style-type: none"> * Running out of label. * The label is installed incorrectly. * Gap/black mark sensor is not calibrated. 	<ul style="list-style-type: none"> * Supply a new label roll. * Please refer to the steps in user's manual to reinstall the label roll. * Calibrate the gap/black mark sensor.
Paper Jam	<ul style="list-style-type: none"> * Gap/black mark sensor is not set properly. * Make sure label size is set properly. * Labels may be stuck inside the print engine mechanism. 	<ul style="list-style-type: none"> * Calibrate the media sensor. * Set media size correctly. * Remove the stuck label inside the print engine mechanism.
Can't downloading the file to memory (FLASH / CARD)	<ul style="list-style-type: none"> * The space of memory is full. 	<ul style="list-style-type: none"> * Delete unused files in the memory.
SD card is unable to use	<ul style="list-style-type: none"> * SD card is damaged. * SD card doesn't insert correctly. * Use the non-approved SD card manufacturer. 	<ul style="list-style-type: none"> * Use the supported capacity SD card. * Insert the SD card again.

Poor Print Quality	<ul style="list-style-type: none"> * Ribbon and media is loaded incorrectly * Dust or adhesive accumulation on the print head. * Print density is not set properly. * Printhead element is damaged. * Ribbon and media are incompatible. * The printhead pressure is not set properly. 	<ul style="list-style-type: none"> * Reload the supply. * Clean the print head. * Clean the platen roller. * Adjust the print density and print speed. * Run self-test and check the print head test pattern if there is dot missing in the pattern. * Change proper ribbon or proper label media. * Adjust the printhead pressure adjustment knob. * The release lever does not latch the printhead properly.
Missing printing on the left or right side of label	<ul style="list-style-type: none"> * Wrong label size setup. 	<ul style="list-style-type: none"> * Set the correct label size.
Gray line on the blank label	<ul style="list-style-type: none"> * The print head is dirty. * The platen roller is dirty. 	<ul style="list-style-type: none"> * Clean the print head. * Clean the platen roller.
Irregular printing	<ul style="list-style-type: none"> * The print engine is in Hex Dump mode. * The RS-232 setting is incorrect. 	<ul style="list-style-type: none"> * Turn off and on the print engine to skip the dump mode. * Re-set the Rs-232 setting.
Label feeding is not stable (skew) when printing	<ul style="list-style-type: none"> * The media guide does not touch the edge of the media. 	<ul style="list-style-type: none"> * If the label is moving to the right side, please move the label guide to left. * If the label is moving to the left side, please move the label guide to right.
Skip labels when printing	<ul style="list-style-type: none"> * Label size is not specified properly. * Sensor sensitivity is not set properly. * The media sensor is covered with dust. 	<ul style="list-style-type: none"> * Check if label size is setup correctly. * Calibrate the sensor by Auto Gap or Manual Gap options. * Clear the GAP/Black mark sensor by blower.
Wrinkle Problem	<ul style="list-style-type: none"> * Printhead pressure is incorrect. * Ribbon installation is incorrect. * Media installation is incorrect. * Print density is incorrect. * Media feeding is incorrect. 	<ul style="list-style-type: none"> * Please refer to the next chapter. * Please set the suitable density to have good print quality. * Make sure the label guide touch the edge of the media guide.
RTC time is incorrect when reboot the print engine	<ul style="list-style-type: none"> * The battery has run down. 	<ul style="list-style-type: none"> * Check if there is a battery on the main board.
The left side printout position is incorrect	<ul style="list-style-type: none"> * Wrong label size setup. * The parameter Shift X in LCD menu is incorrect. 	<ul style="list-style-type: none"> * Set the correct label size. * Press [MENU] → [SELECT] x 3 → [DOWN] x 5 → [SELECT] to fine tune the parameter of Shift X.

The printing position of small label is incorrect

- * Media sensor sensitivity is not set properly.
- * Label size is incorrect.
- * The parameter Shift Y in the LCD menu is incorrect.
- * The vertical offset setting in the driver is incorrect.

- * Calibrate the sensor sensitivity again.
- * Set the correct label size and gap size.
- * Enter LCD menu (or via DiagTool) to fine tune the parameter of Shift Y.
- * If using the software BarTender, please set the vertical offset in the driver.

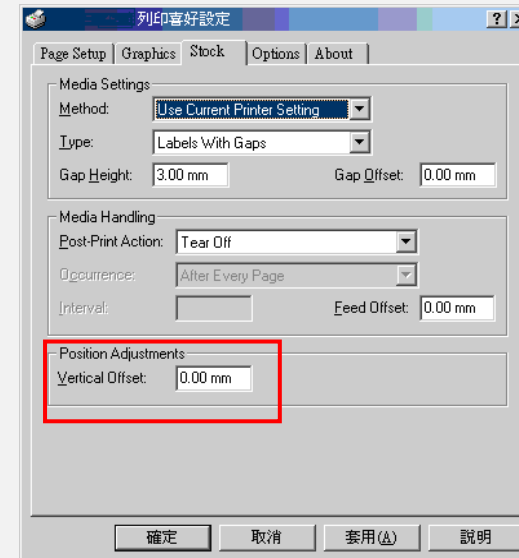

8. Maintenance

This session presents the clean tools and methods to maintain the printer.

■ For Cleaning

Depending on the media used, the printer may accumulate residues (media dust, adhesives, etc.) as a by-product of normal printing. To maintain the best printing quality, you should remove these residues by cleaning the printer periodically. Regularly clean the print head and supply sensors once change a new media to keep the printer at the optimized performance and extend printer life.

■ For Disinfecting

Sanitize your printer to protect yourself and others and can help prevent the spread of viruses.

■ Important

- Set the printer power switch to O (Off) prior to performing any cleaning or disinfecting tasks. Leave the power cord connected to keep the printer grounded and to reduce the risk of electrostatic damage.
- Do not wear rings or other metallic objects while cleaning any interior area of the printer.
- Use only the cleaning agents recommended in this document. Use of other agents may damage the printer and void its warranty.
- Do not spray or drip liquid cleaning solutions directly into the printer. Apply the solution on a clean lint-free cloth and then apply the dampened cloth to the printer.
- Do not use canned air in the interior of the printer as it can blow dust and debris onto sensors and other critical components.
- Only use a vacuum cleaner with a nozzle and hose that are conductive and grounded to drain off static build up.
- All reference in these procedures for use of isopropyl alcohol requires that a 99% or greater isopropyl alcohol content be used to reduce the risk of moisture corrosion to the printhead.
- Do not touch printhead by hand. If you touch it carelessly, please use 99% Isopropyl alcohol to clean it.
- Always taking personal precaution when using any cleaning agent.

Cleaning Tools

- Cotton swab
- Lint-free cloth
- Brush with soft non-metallic bristles
- Vacuum cleaner
- 75% Ethanol (for disinfecting)
- 99% Isopropyl alcohol (for printhead and platen roller cleaning)
- Genuine printhead cleaning pen
- Mild detergent (without chlorine)

Cleaning Process:

Printer Part	Method	Interval
Print Head	<ol style="list-style-type: none"> I. Always turn off the printer before cleaning the printhead. II. Allow the printhead to cool for at least one minute. III. Use a cotton swab and 99% Isopropyl Alcohol or genuine print head cleaning pen to clean the print head surface. 	Clean the print head when changing a new label roll.
Platen Roller	<ol style="list-style-type: none"> I. Turn off the printer. II. Rotate the platen roller and wipe it thoroughly with the lint-free 99% Isopropyl Alcohol. 	Clean the platen roller when changing a new label roll
Peel Bar	Use the lint-free cloth with 99% Isopropyl Alcohol to wipe it.	As needed
Sensor	Use brush with soft non-metallic bristles or a vacuum cleaner, to remove paper dust. Clean upper and lower media sensors to ensure reliable Top of Form and Paper Out sensing.	Monthly
Exterior	Clean the exterior surfaces with a clean, lint-free cloth (water-dampened cloth). If necessary, use a mild detergent or desktop cleaning solution then use the 75% Ethanol to wipe it.	As needed
Interior	Clean the interior of the printer by removing any dirt and lint with a vacuum cleaner, as described above, or use a brush with soft non-metallic bristles then use the 75% Ethanol to wipe it.	As needed

9. Agency Compliance and Approvals



EN 55032: Class A
EN 55024
EN 55035
EN 61000
EN 60950-1
EN 62368-1

This is a class A product. In a domestic environment this product may cause radio interference in which case the user may be required to take adequate measures.

FCC part 15B, Class A
ICES-003, Class A

This equipment has been tested and found to comply with the limits for a Class A digital device, pursuant to Part 15 of the FCC Rules. These limits are designed to provide reasonable protection against harmful interference when the equipment is operated in a commercial environment.



Operation is subject to the following two conditions: (1) This device may cause harmful interference, and (2) this device must accept any interference received, including interference that may cause undesired operation.

This equipment generates, uses, and can radiate radio frequency energy and, if not installed and used in accordance with the manufacturer's instruction manual, may cause harmful interference with radio communications. Operation of this equipment in a residential area is likely to cause harmful interference, in which case you will be required to correct the interference at your own expense.

This Class A digital apparatus complies with Canadian ICES-003.
Cet appareil numérique de la classe A est conforme à la norme NMB-003 du Canada.



AS/NZS CISPR 32, Class A



UL 62368-1:2014
 CAN/CSA-C22.2 NO. 62368-1
 UL 60950-1 : 2007
 CAN/CSA-C22.2 NO. 60950-1

Mexico CoC

UL 60950



KN 32
 KN 35
 K60950-1(2011-12)

이 기기는 업무용(A 급) 전자파적합기기로서 판매자 또는 사용자는 이 점을 주의하시기 바라며, 가정외의 지역에서 사용하는 것을 목적으로 합니다.



GB 4943.1
 GB/T9254, Class A
 GB 17625.1

此为 A 级产品，在生活环境中，该产品可能会造成无线电干扰，在这种情况下，可能需要用户对干扰采取切实可行的措施。



Energy Star for Imaging Equipment Version 3.0



TP TC 004
 TP TC 020



CNS 13438
 CNS 14336-1
 CNS 15663



IS 13252(Part 1)/
 IEC 60950-1

Note: There may have certification differences in the series models, please refer to product label for accuracy.

Important safety instructions:

1. Read all of these instructions and keep them for later use.

2. Follow all warnings and instructions on the product.
3. Disconnect the power from the AC inlet before cleaning or if fault happened.
Do not use liquid or aerosol cleaners. Using a damp cloth is suitable for cleaning.
4. The mains socket shall be installed near the equipment and easily accessible.
5. The unit must be protected against moisture.
6. Ensure the stability when installing the device, Tipping or dropping could cause damage.
7. Make sure to follow the correct power rating and power type indicated on marking label provided by manufacture.
8. Please refer to user manual for maximum operation ambient temperature provided by manufacture.



WARNING:

Moving parts. Keep finger or body away from moving parts.

CAUTION:

(For equipment with RTC (CR2032) battery or rechargeable battery pack)

Risk of explosion if battery is replaced by an incorrect type.

Dispose of used batteries according to the Instructions as below.

1. DO NOT throw the battery in fire.
2. DO NOT short circuit the contacts.
3. DO NOT disassemble the battery.
4. DO NOT throw the battery in municipal waste.
5. The symbol of the crossed out wheeled bin indicates that the battery should not be placed in municipal waste.



Caution: Hot surface for printhead.

Do not touch the printhead before it cooling.

WARNING:

Remove the power from AC inlet before opening the media cover for cleaning or repairing faults. After cleaning or fixing faults, media cover closing before power connecting to AC inlet.

CAUTION:

Any changes or modifications not expressly approved by the grantee of this device could void the user's authority to operate the equipment.

CE Statement:

This equipment complies with EU radiation exposure limits set forth for an uncontrolled environment. This equipment should be installed and operated with minimum distance 20 cm between the radiator & your body.

All operational modes:

2.4GHz: 802.11b, 802.11g, 802.11n (HT20), 802.11n (HT40)

5GHz: 802.11a,

The frequency, mode and the maximum transmitted power in EU are listed below:

2400 MHz – 2483.5 MHz: 19.88 dBm (EIRP)

5150 MHz – 5250 MHz: 17.51 dBm (EIRP)

5150-5350MHz for Only indoor use

5470-5725MHz for indoor/outdoor use

Restrictions In AZE

National restrictions information is provided below

Frequency Band	Country	Remark
5150-5350MHz	Azerbaijan	No license needed if used indoor and power not exceeding 30mW
5470-5725MHz		

Hereby, TSC Auto ID Technology Co., Ltd. declares that the radio equipment type [Wi-Fi] IEEE 802.11 a/b/g/n is in compliance with

Directive 2014/53/EU

The full text of the EU declaration of conformity is available at the following internet address: [http:// www.tscprinters.com](http://www.tscprinters.com)

RF exposure warning (Wi-Fi)

This equipment must be installed and operated in accordance with provided instructions and must not be co-located or operating in conjunction with any other antenna or transmitter. End-users and installers must be providing with antenna installation instructions and transmitter operating conditions for satisfying RF exposure compliance.

SAR Value: 0.736 W/kg

RF exposure warning (For Bluetooth)

The equipment complies with FCC RF exposure limits set forth for an uncontrolled environment.

The equipment must not be co-located or operating in conjunction with any other antenna or transmitter.

Canada, Industry Canada (IC) Notices

This Class B digital apparatus complies with Canadian ICES-003 and RSS-210.

Operation is subject to the following two conditions: (1) this device may not cause interference, and (2) this device must accept any interference, including interference that may cause undesired operation of the device.

Radio Frequency (RF) Exposure Information

The radiated output power of the Wireless Device is below the Industry Canada (IC) radio frequency exposure limits. The Wireless Device should be used in such a manner such that the potential for human contact during normal operation is minimized.

This device has been evaluated for and shown compliant with the IC Specific Absorption Rate (“SAR”) limits when installed in specific host products operated in portable exposure conditions. **(For Wi-Fi)**

This device has also been evaluated and shown compliant with the IC RF Exposure limits under portable exposure conditions. (Antennas are less than 20 cm of a person's body). **(For Bluetooth)**

Canada, avis de l'Industry Canada (IC)

Cet appareil numérique de classe B est conforme aux normes canadiennes ICES-003 et RSS-210.

Son fonctionnement est soumis aux deux conditions suivantes : (1) cet appareil ne doit pas causer d'interférence et (2) cet appareil doit accepter toute interférence, notamment les interférences qui peuvent affecter son fonctionnement.

Informations concernant l'exposition aux fréquences radio (RF)

La puissance de sortie émise par l'appareil sans fil est inférieure à la limite d'exposition aux fréquences radio de l'Industry Canada (IC). Utilisez l'appareil sans fil de façon à minimiser les contacts humains lors du fonctionnement normal.

Ce périphérique a été évalué et démontré conforme aux limites SAR (Specific Absorption Rate – Taux d'absorption spécifique) par l'IC lorsqu'il est connecté à des dispositifs hôtes spécifiques opérant dans des conditions d'utilisation mobile. **(Pour le Wi-Fi)**

Ce périphérique a également été évalué et démontré conforme aux limites d'exposition radio-fréquence par l'IC pour des utilisations par des opérateurs mobiles (les antennes sont à moins de 20 cm du corps d'une personne). **(Pour le Bluetooth)**

NCC 警語:

經型式認證合格之低功率射頻電機，非經許可，公司、商號或使用者均不得擅自變更頻率、加大功率或變更原設計之特性及功能。(即

低功率電波輻射性電機管理辦法第十二條)

低功率射頻電機之使用不得影響飛航安全及干擾合法通信；經發現有干擾現象時，應立即停用，並改善至無干擾時方得繼續使用。

前項合法通信，指依電信法規定作業之無線電通信。低功率射頻電機須忍受合法通信或工業、科學及醫療用電波輻射性電機設備之干

擾。(即低功率電波輻射性電機管理辦法第十四條)

10. Revise History

Date

Content

Editor

TSC **PRINTRONIX**[®]
AUTO ID