

cino

FuzzyScan Barcode Scanners
Barcode Programming Manual

Version A3





FuzzyScan Barcode Scanners

Barcode Programming Manual

International Edition, Version A3

Disclaimer

Cino makes no warranty of any kind with regard to this publication, including, but not limited to, the implied warranty of merchantability and fitness for any particular purpose. Cino shall not be liable for technical or editorial errors or omissions contained herein; nor for incidental or consequential damages resulting from the furnishing, performance, or use of this material. Cino disclaims all responsibility for the selection and use of software and/or hardware to achieve intended results. Cino reserves the right to make changes in specifications and other information contained in this document without prior notice, and the reader should in all cases consult Cino to determine whether any such changes have been made. The information in this publication does not represent a commitment on the part of Cino.

Warranty

For warranty information, please contact Cino. Our contact information is available on www.cino.com.tw.

Copyright

This document contains proprietary information that is protected by copyright. All rights are reserved. No part of this document may be photocopied, reproduced, or translated into another language in any form without the prior written consent of Cino. This includes electronic or mechanical means, such as photocopying, recording, or information storage and retrieval systems.

© COPYRIGHT CINO GROUP • PC WORTH INT'L CO., LTD. ALL RIGHTS RESERVED.

Revision History

Revision	Released Date	Description
A1	Sep. 14, 2022	❖ First release
A2	Nov. 15, 2022	❖ Changed option code of Fixed Mount Scanners Operation Mode ❖ Added User-defined Function Key ❖ Added Appendix – Function Key Character Table ❖ Added OK/NG indicator-related options of OK/NG Signal Output ❖ Added GS1 Prefix/Suffix Output ❖ Added GS1 Format Mismatch Rule ❖ Changed default option of OK/NG Beeping ❖ Renamed to Handheld Decode Timeout and Handsfree Decode Timeout ❖ Renamed to Handheld Center Alignment and Handsfree Center Alignment ❖ Renamed to 2D Handheld Illumination & Aiming Control and 2D Handsfree Illumination & Aiming Control
A3	Jan. 03, 2023	❖ Renamed Presentation Trigger to Presentation Trigger Select ❖ Renamed Presentation Scan to Presentation Continuous Scan ❖ Changed default option of MicroPDF Readability

About This Manual

This programming manual provides general instructions on setting up Cino's FuzzyScan scanners.

- **Chapter 1, Overview**

This chapter contains an overview of the system commands, quick set commands, family codes, and option codes used when setting up FuzzyScan barcode scanners. It also presents general information on Cino's programming procedures, as well as simple flowcharts to help users better understand the configuration process.

- **Chapter 2, Host Interface Settings**

This chapter presents different parameters to help users with host interface selection and related configurations. Here, you will find settings that pertain to keyboard interface output (such as keypad layout and code pages), and serial interface output (such as baud rate, data frame, and more).

- **Chapter 3, Barcode Reading Control**

This chapter contains the parameters that will help users set up their scanners to read different types of barcodes supported by FuzzyScan scanners. Corresponding detailed settings of each code type are also collected in this chapter. Users can enable the Barcode ID function to identify the type of code scanned.

- **Chapter 4, Operation Modes**

This chapter provides a complete list of available operation modes for each product series. To fulfill the needs of different application scenarios, the scanners' default modes and available mode options vary from series to series.

- **Chapter 5, Operation Control**

This chapter presents the parameters related to operation of your scanner. In it, you will find settings for functionalities, including general scanner settings, user feedback control such as buzzer and vibration, and special parameters for different scanner.

- **Chapter 6, Bluetooth Settings**

The information contained in this chapter pertains to the Bluetooth-related settings of FuzzyScan cordless scanners. Presented herein are the parameters for exclusive functions of Bluetooth models (such as batch scanning and validation scanning), as well as general Bluetooth settings related to the device name, security, radio link and time-out settings.

- **Chapter 7, Data Modifications**

This chapter presents the different parameters for altering data before the scanner transmits it. Here, you will find the option to add extra characters or to include an informative element. You can also find the parameters to control the powerful GS1 parsing tool.

- **Appendix**

The Appendix contains additional information that is essential to the programming of your FuzzyScan barcode scanners. In it, you will find useful tables pertaining to 1D barcode ID, 2D barcode ID, keyboard function codes, ASCII/HEX conversion, and code pages. This section also includes quick set commands, systems commands, as well as option codes.

Other Documentation

You may also refer to the documents below for additional information.

- **FuzzyScan Quick Start Guide**

Quick introduction to scanner set-up and operation.

- **FuzzyScan User Manuals**

Information pertaining to the setup and operation of Cino barcode scanners.

- **FuzzyScan Serial Command Manual**

Information on using serial commands to program Cino barcode scanners.

Table of Contents

Disclaimer	2
Warranty	2
Copyright	2
Revision History	3
About This Manual	4
Other Documentation	5
1 OVERVIEW	12
Introduction	13
System Commands	13
Family Codes	13
Option Codes	13
Quick Set Commands	13
iCode	13
Programming Procedures	14
Legend	14
Programming Flowcharts	15
Program & End	15
System List, Group & Master Default	16
Single Scan Selection	17
Multiple Scans Selection	18
Cycling Scan Selection	19
Dual Level Selection	20
2 INTERFACE SETTINGS	22
Host Interface Selection	23
Handheld 2D Imagers	23
Handheld Linear Imagers	24
Fixed Mount and On-counter Scanners	25
HID Keyboard Interface	26
Keyboard Caps Lock	26
Keyboard Caps Lock Release	27
Key Pad Emulation	28
Keyboard Upper/Lower Case	29
Intercharacter, Intermesssage, Interfunction Delay	30
Keyboard Country Layout	31
Encoding Country Code Page	32
Keyboard Output Country Code Page	33
User-defined Function Key	34
USB Data Merge	35
Serial Interface	36
Serial STX/ETX Transmit	36
Intermessage, Intercharacter, and Interfunction Delay	37
Serial Handshaking Protocol	38
Serial Response Timeout, Baud Rate, Data Frame	39

Encoding Country Code Page	40
Serial Output Country Code Page	41
Serial NAK Retry Count	42
Serial ACK Indication	43
3 BARCODE READING	45
Code ID	46
Code ID Transmit	46
Code ID – 1 Character	47
Barcode Readability	49
Readable Barcode Settings	49
Barcode Settings	50
Code 39/32, Trioptic Code 39	50
Code 39	51
Code 93	55
Code 128	56
Codabar	58
UPC	61
EAN	65
UCC Coupon Extended Code	70
IATA	71
Interleaved 25 (ITF)	73
Code 25 Family	74
Code 11	77
MSI	79
UK/Plessey	81
Telepen	83
Composite Code	85
PDF417, MicroPDF417	86
QR Code	87
Data Matrix	90
MaxiCode	92
Aztec Code	93
Postal Code Settings	95
Australia Post Code	95
British Post Code	96
Netherlands KIX Code, Posi LAPA Code	97
Japan Post, Korea Post Code	98
US Planet	99
US POSTNET	100
Intelligent Mail	101
GS1 Settings	102
GS1 128	102
GS1 DataBar	103

4 OPERATION MODES.....	106
Corded Handheld Imagers.....	107
Cordless Handheld Imagers.....	108
Companion Scanners.....	109
Fixed Mount Scanners.....	110
On-counter Scanners.....	111
5 OPERATION CONTROL	113
Scanner Operation	114
Reread Delay, Good Read Delay.....	114
Handheld Decode Timeout.....	115
Handsfree Decode Timeout.....	116
Presentation Trigger Select.....	117
Presentation Continuous Scan.....	118
Object-in/Object-out Message Output.....	119
2D Image Sensitivity.....	120
1D Barcode Inverse Reading.....	121
Handsfree Timeout.....	122
Auto-sense Control.....	123
Auto-sense Mode Select.....	124
Laser Auto-sense Power Off Timeout.....	125
NG Message Output.....	126
Handheld & Handsfree Center Alignment.....	127
Unique Barcode Reporting.....	128
2D Smart Scene.....	129
1D Reading Redundancy.....	130
1D Scan Rate.....	131
1D Reading Direction Indication.....	132
1D Barcode Forward/Backward-reading Indication.....	133
OK/NG Signal Output.....	134
OK/NG Signal Active State.....	135
OK/NG Signal Duration.....	136
Scanner Light Control.....	137
2D Illumination & Aiming Control.....	137
2D Aiming Select, Pre-decode Aiming Timeout.....	138
Laser Aiming Control.....	139
Laser Aiming Select, Pre-decode Aiming Timeout.....	140
User Interactions.....	141
Buzzer Tone, Buzzer Volume.....	141
Good Read Beeping.....	142
Power On/Off Beeping.....	143
Good Read Indicator, Power-on Indicator.....	144
Vibration Control.....	145
Good Read Duration.....	146
OK/NG Beeping.....	147

6 BLUETOOTH SETTINGS 149

General Bluetooth Settings 150

BT Device Name	150
BT PIN Code.....	151
BT Discoverable Protocol Selection	152
BT Link Quality	153
BT Out-of-range Scanning	154
BT Radio Off Timeout, Connected & Disconnected	155
BT Power off Timeout.....	156
BT On-screen Keyboard	157
BT HID Transmit Delay	158
BT Connect Beeping Control & Select.....	159
BT Battery Low Beeping.....	160
BT Low Power Link Indicator.....	161
BT Sniff Control	162
BT Cradle PAIR Lock.....	163

Bluetooth Special Modes 164

Batch Scanning Link Control.....	164
Batch Scanning Data Transmit.....	165
Batch Scanning Data Delete	166
Batch Scanning ID Output	167
Batch Scanning Quantity Transmit	168
Batch Scanning Field Delimiter	169
Validation Scanning Link Control	170
Validation Scanning Master Data	171
Validation Scanning Output Select	172
Companion FN2 Select	173

7 DATA MODIFICATIONS..... 175

Global Settings..... 176

Preamble.....	176
Postamble.....	177
Record Suffix (Keyboard).....	178
Record Suffix (Serial).....	179
Dollar Sign Convert.....	180
FNC1 Transmit.....	181
Data Length Transmit.....	182
Code ID Transmit.....	183
ECI ID Transmit.....	184

GS1 Settings..... 185

GS1 Special Function	185
GS1 1st FNC1 Transmit	186
GS1 Noninitial FNC1 Transmit	187
GS1 AI Transmit.....	188
GS1 Failure Rule.....	189

GS1 Prefix/Suffix Output.....	190
GS1 Format Mismatch Rule	191
GS1 Date Field 'DD=00' Transmit.....	192
GS1 Decimal Point Insert.....	193
GS1 Element String Separator.....	194
GS1 Data Separator	195
APPENDIX.....	197
Code ID Table.....	198
Code ID for 1D Barcodes	198
Code ID for 2D Barcodes	199
ASCII Input Shortcut.....	200
HEX/ASCII Reference Table	200
Function Key Output Table.....	201
Function Key Character Table.....	202
Code Page	206
Table of corresponding languages	206
Unicode Hex Input Setup.....	207

1 OVERVIEW

This chapter contains an overview of the system commands, quick set commands, family codes, and option codes used when setting up FuzzyScan barcode scanners. It also presents general information on Cino's programming procedures, as well as simple flowcharts to help users better understand the device configuration process.

Introduction

FuzzyScan command barcodes are specially designed barcodes that allow you to program Cino scanners. They can be grouped into three main categories: **System Commands**, **Family Codes** and **Option Codes**.

Detailed explanations and programming flowcharts are provided below.

System Commands

System Commands direct FuzzyScan imagers to perform immediate operations, ie. enter programming mode (**PROGRAM**), exit programming mode (**END**), list system information (**SYSLIST**), and return to factory settings (**F_DEFAULT**). It will take a few seconds to complete the system command operations, users must wait for the completion beeps before scanning another barcode.

Family Codes

Each parameter has a specific family code as its identification. There are over one hundred family codes available.

Option Codes

Option Codes are a set of command barcodes represented by the characters "0–9", "A–F" and **FIN** (finish selection). For most settings, you must choose at least one option code after selecting a family code to set the desired parameter.

Quick Set Commands

Quick set commands are command barcodes designed to rapidly set your FuzzyScan imager to a particular operation mode, host interface setting, Bluetooth link mode, or keyboard language layout.

iCode

The iCode is a macro command barcode designed to streamline your setup process. Instead of scanning multiple command barcodes to configure their devices, users can easily generate a single iCode that contains all of the relevant parameters. Your entire setup can thus be completed with one quick scan. This simplified procedure lowers the risk of configuration errors, accelerates deployments, and reduces field service and expenses. Please refer to iCode brochure on www.cino.com.tw for details.

Programming Procedures

Selected parameters are stored in the internal Flash Memory ASIC or non-volatile memory, even after the scanner is powered off.

Most family codes require the **Single Scan Selection** programming procedure. Other family codes have more sophisticated procedures, such as **Multiple Scans Selection**, **Cycling Scan Selection** or **Dual Level Selection**. The flowcharts for each procedure is provided below.

The beeping indications for each FuzzyScan model can be found in the corresponding user manuals. They will help you recognize the scanner's status during configuration.

Legend

Conventions	Descriptions
◀	Factory Default Value
PP	Programming Procedure SS : Single scan selection MS : Multiple scans selection CS : Cycling scan selection DS : Dual level scan selection
OC1	Option Code 1
OC2	Option Code 2
()	Necessary Option Code
[]	Selectable Option Code
ALL	Family Code applies to all FuzzyScan models
2D ONLY	Family Code only applied to FuzzyScan 2D imager models: A700/BT, A600/BT, A500, FA400, PA600, S600, and SM5000 series
1D ONLY	Family Code only applied to FuzzyScan linear imager models: F700/BT, F600/BT, F500, L700/BT, L600/BT, FM400, PF600BT, PL600BT, SM400/300 series
HANDHELD	Family Code only applied to FuzzyScan handheld models: A700/BT, A600/BT, A500, F700/BT, F600/BT, F500, L700/BT, L600/BT, PA600BT, PF600BT, PL600BT series
FIXED MOUNT	Family Code only applied to FuzzyScan fixed mount models: FA400, FM400, SM5000, SM400/300 series
ON COUNTER	Family Code only applied to FuzzyScan on-counter models: S600 series
LASER ONLY	Family Code only applied to FuzzyScan laser imager models: L700/BT, L600/BT, PL600BT series
BLUETOOTH	Family Code only applied to FuzzyScan laser imager models: A700BT, A600BT, F700BT, F600BT, L700BT, L600BT, PA600BT, PF600BT, PL600BT series

Programming Flowcharts

Program & End

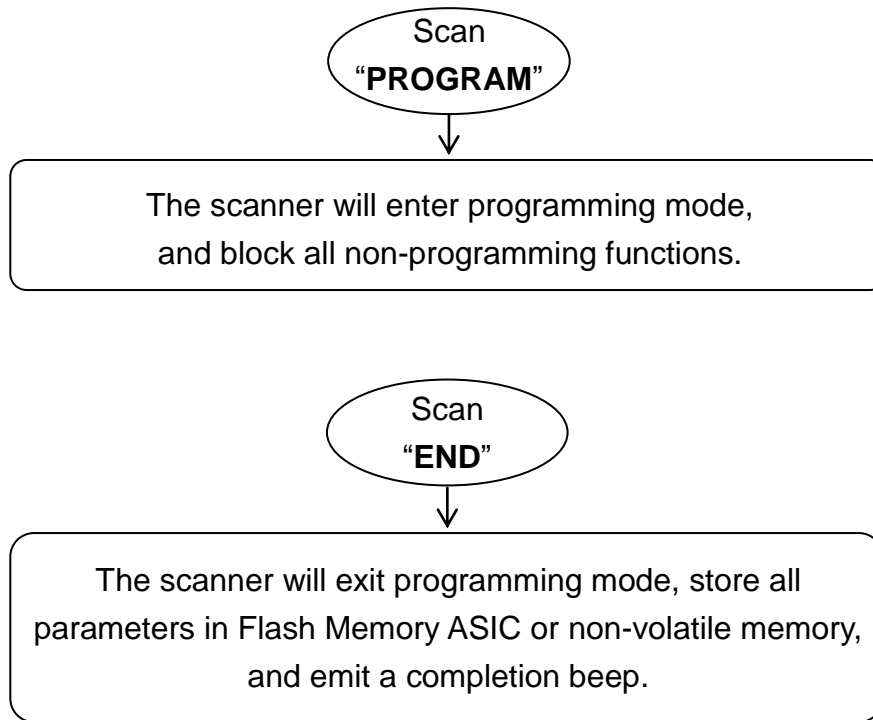

It will take 3-4 seconds for the parameters to be stored after scanning "END". Please **do not** turn off your scanner before hearing the completion beep. Otherwise, the parameters settings may be lost.

System List, Group & Master Default

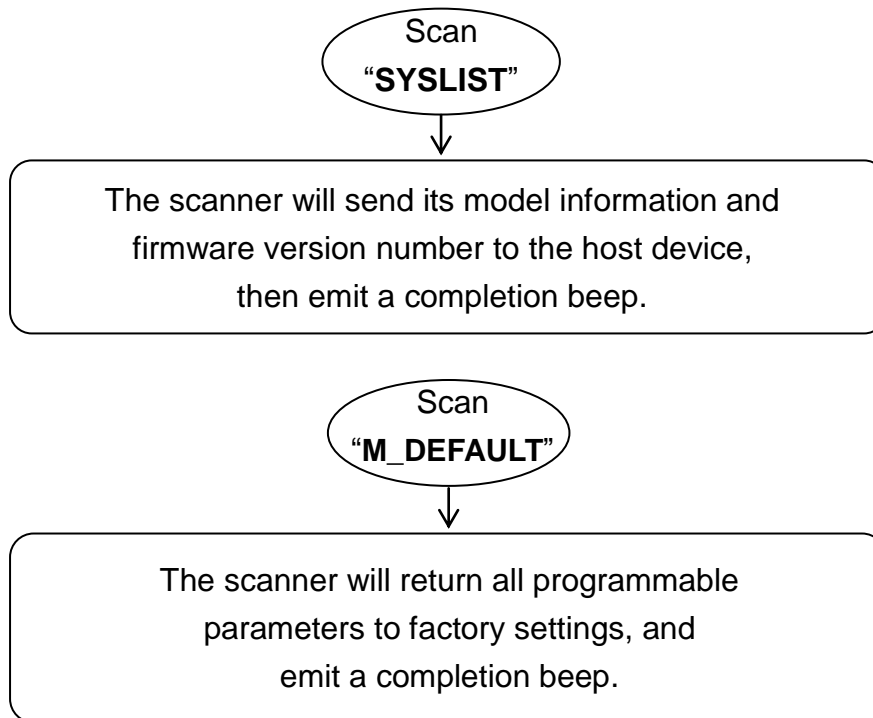

Single Scan Selection

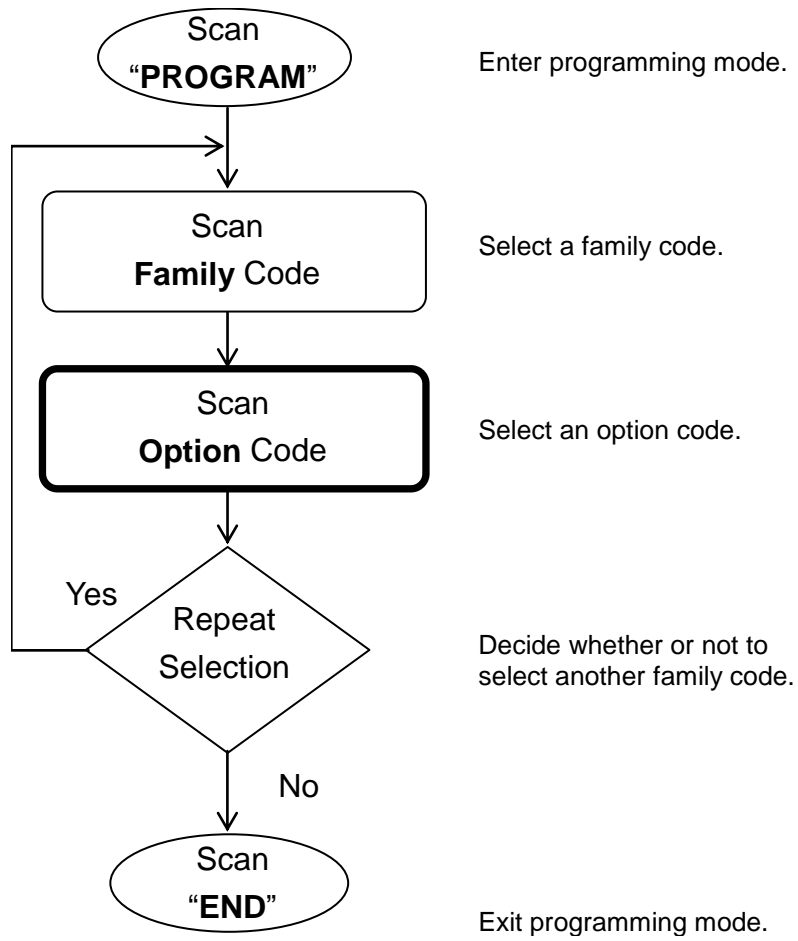

Multiple Scans Selection

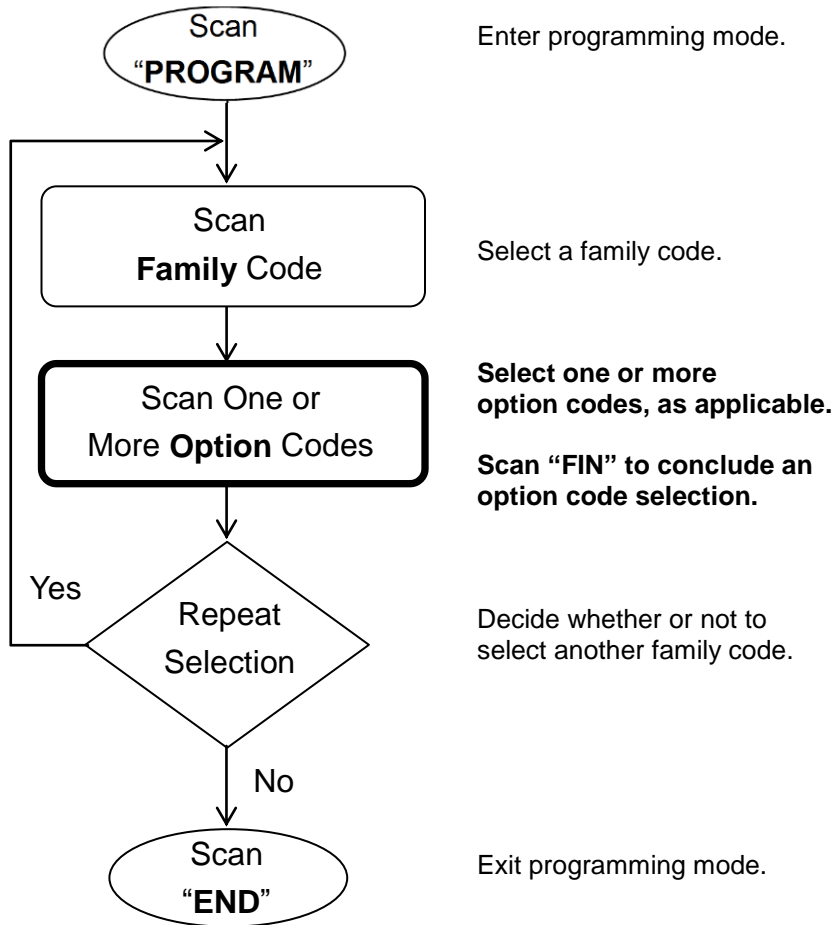

Cycling Scan Selection

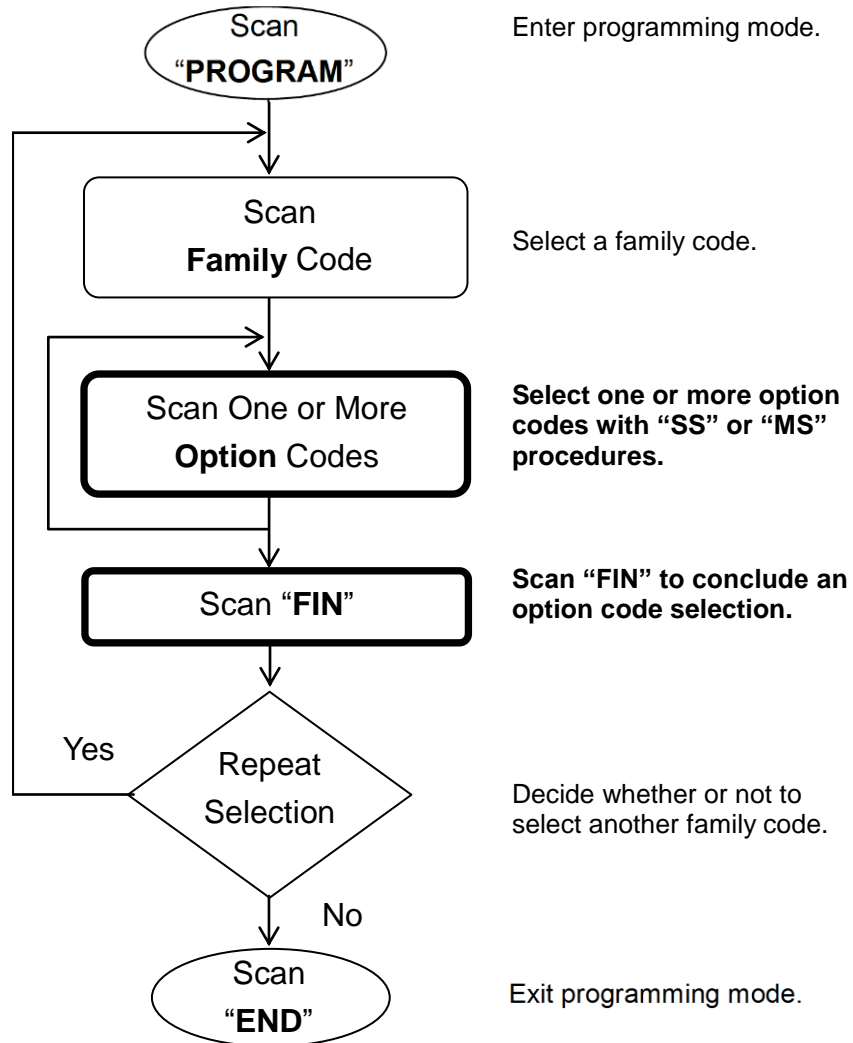

Dual Level Selection

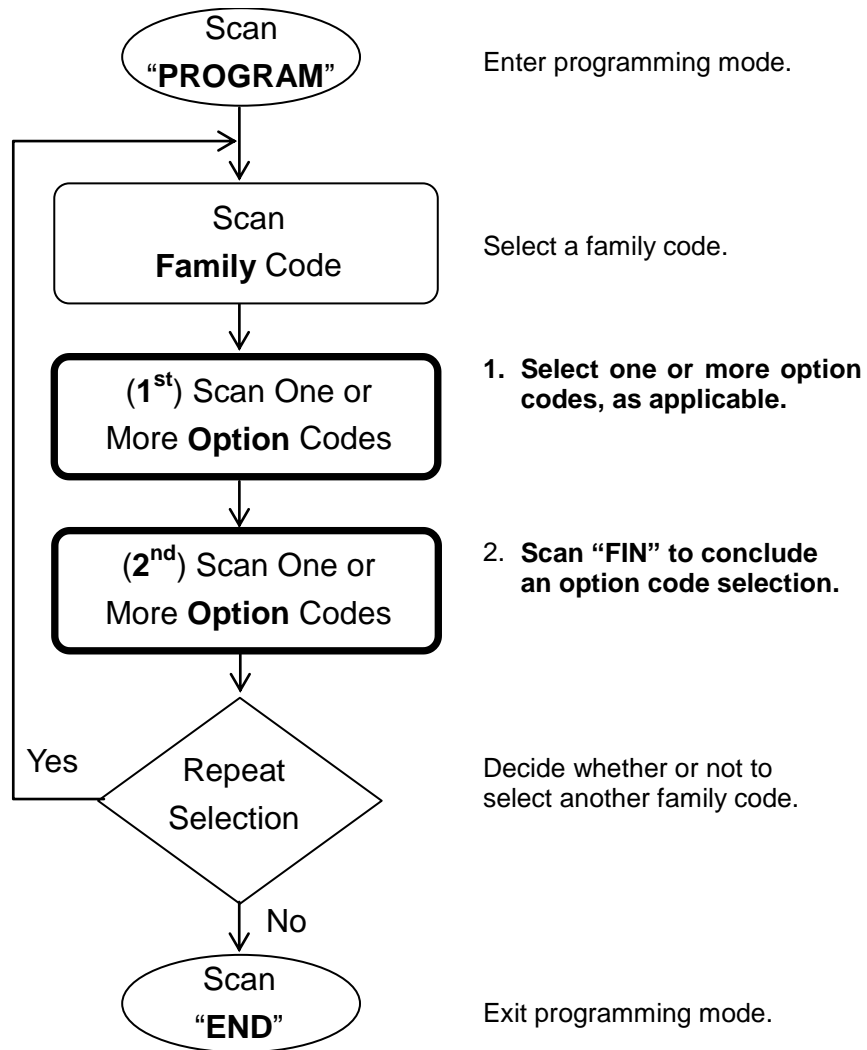

2 INTERFACE SETTINGS

This chapter presents different parameters to help users with host interface selections and related configurations. Here, you will find settings that pertain to keyboard interface output such as keypad layout, code pages, and serial interface outputs (such as baud rate, data frame, and more).

Host Interface Selection
Handheld 2D Imagers



Program

Family Code	PP	Parameter Selection	Option Code
 Host Interface	MS	USB OEM	05
	MS	RS232 serial	06
	MS	USB CDC/Virtual COM	09
	MS	USB HID keyboard ◀	18

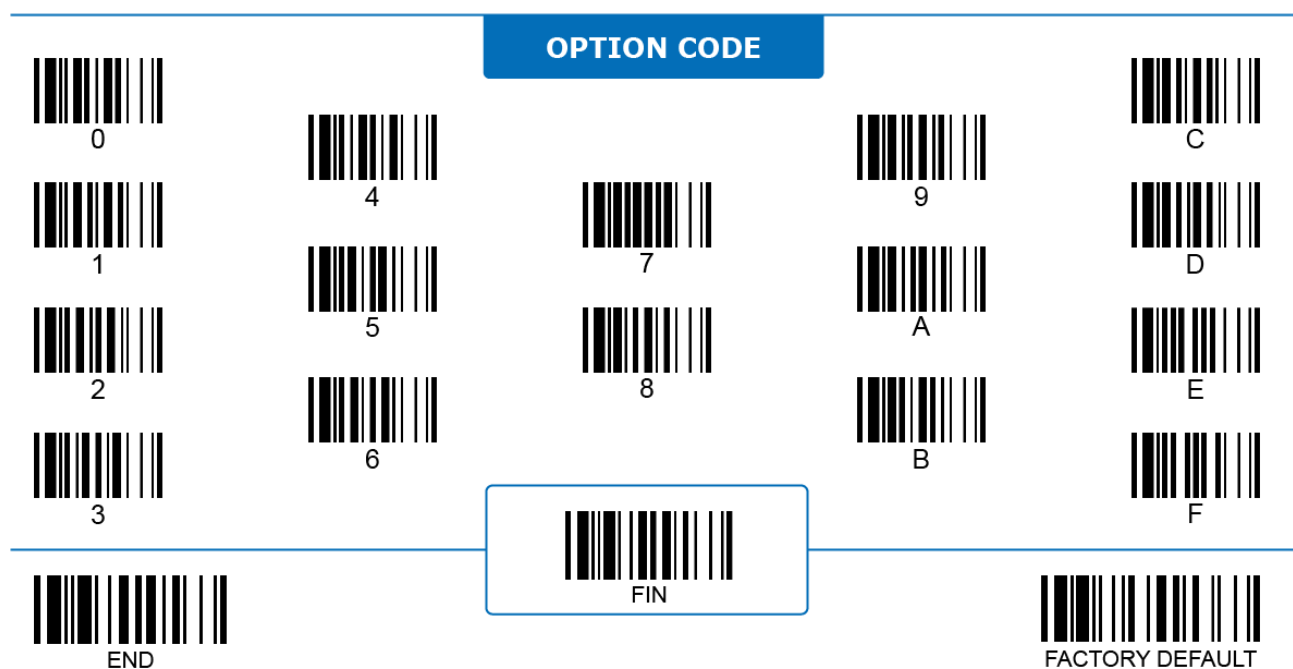

Host Interface Selection Handheld Linear Imagers



Program

Family Code	PP	Parameter Selection	Option Code
 Host Interface	MS	RS232 serial	06
	MS	Wand emulation	08
	MS	USB CDC/Virtual COM	09
	MS	Laser emulation	17
	MS	USB HID keyboard ◀	18

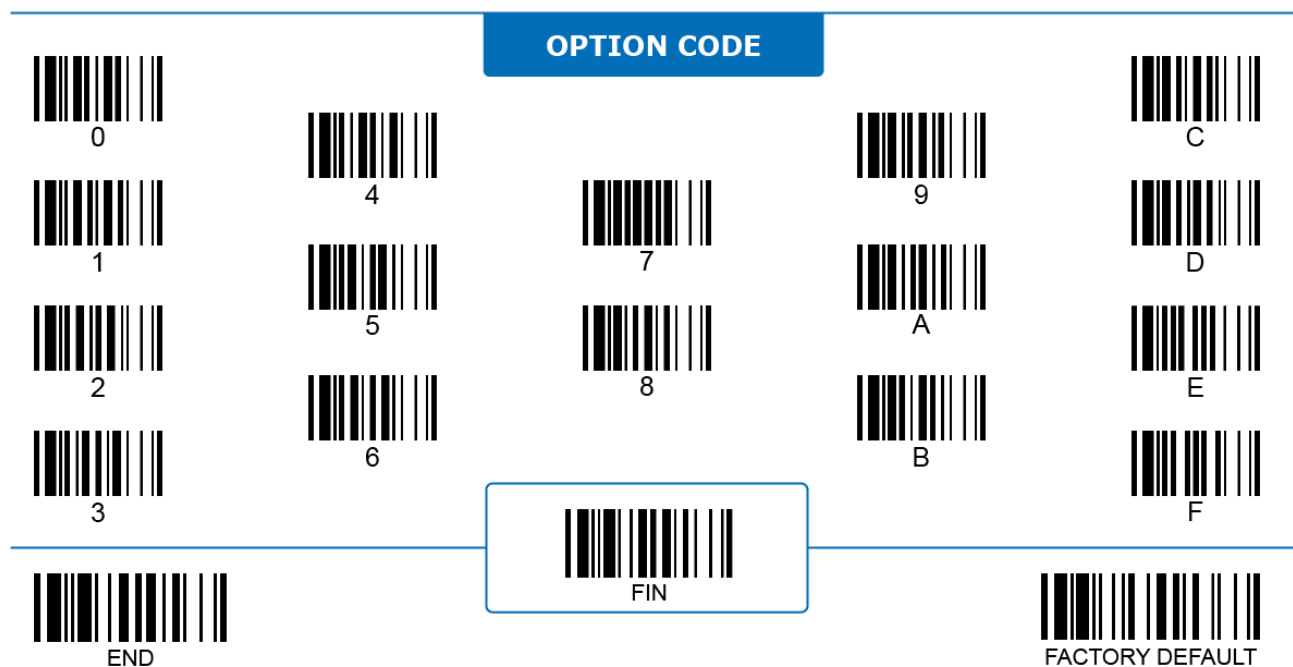

Host Interface Selection

Fixed Mount and On-counter Scanners



Program

Family Code	PP	Parameter Selection	Option Code
 Host Interface	MS	USB OEM	05
	MS	RS232 serial	06
	MS	USB CDC/Virtual COM	09
	MS	USB HID keyboard ◀	18

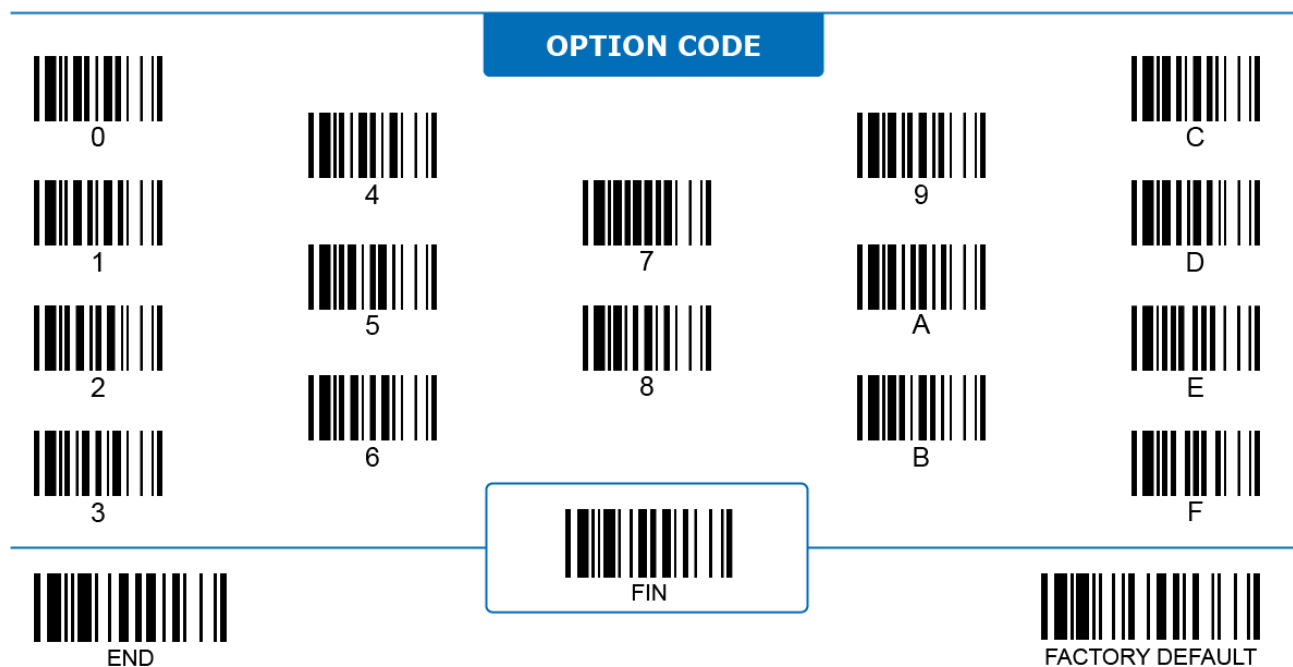

HID Keyboard Interface

Keyboard Caps Lock



Program

ALL

Family Code	PP	Parameter Selection	Option Code
 Keyboard Caps Lock	SS	Caps Lock Off ◀	0
	SS	Caps Lock On	1
	SS	Auto detect	2

Keyboard Caps Lock is designed to control whether the actual character outputs in upper or in lower case.

- i. **Caps Lock Off:** When selected, the scanner transmits data in the **original state** if “Caps Lock” on the host keyboard is **off**, or transmits data in the **opposite state** if “Caps Lock” on the host keyboard is **on**.
- ii. **Caps Lock On:** When selected, the scanner transmits data in the **opposite state** if “Caps Lock” on host keyboard is **off**, or transmits data in the **original state** if “Caps Lock” on the host keyboard is **on**.
- iii. **Auto detect:** When selected, the scanner always transmits data in the **original state** with the help of special transmission handshaking with the host device.

Keyboard Caps Lock is only available with IBM PP/AT, PS/VP, PS/2 series personal computers and compatible machines.

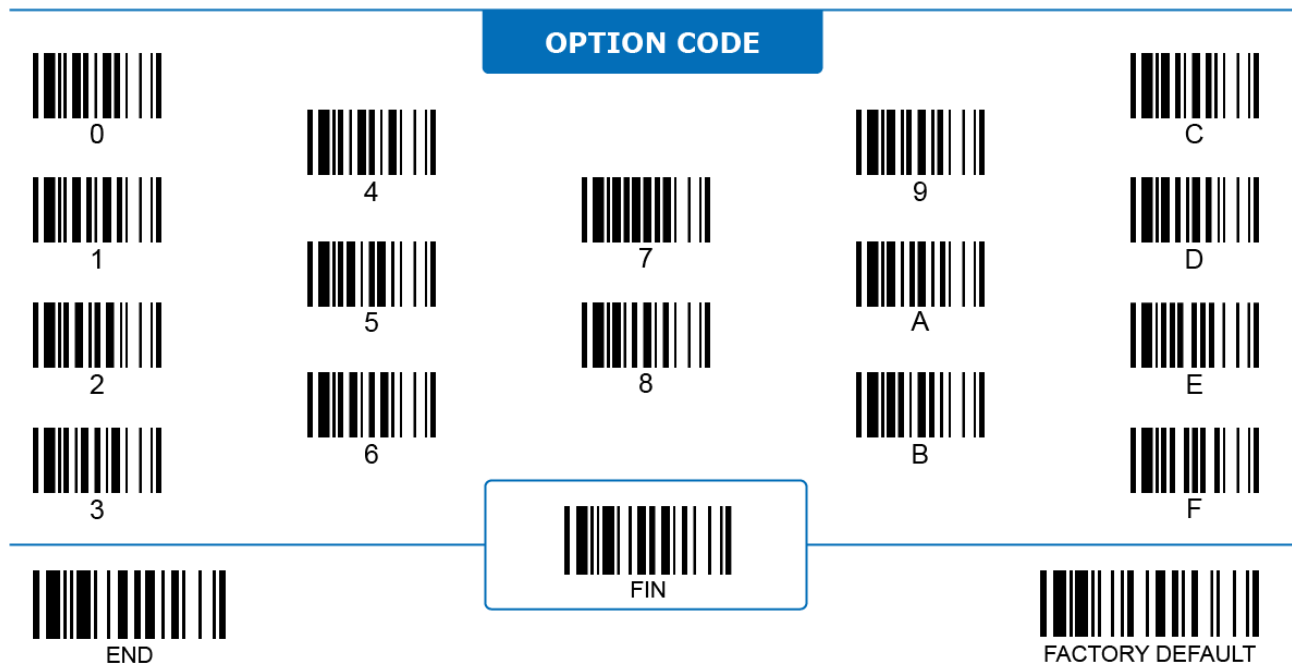

HID Keyboard Interface

Keyboard Caps Lock Release



Program

ALL

Family Code	PP	Parameter Selection	Option Code
 Keyboard Caps Lock Release	SS	Caps Lock On, Caps Off ◀	0
	SS	Caps Lock On, Shift Off	1

Keyboard Caps Lock Release controls how to release “Caps Lock” on host keyboard, by pressing the “Caps Lock” key again or by pressing the “Shift” key instead.

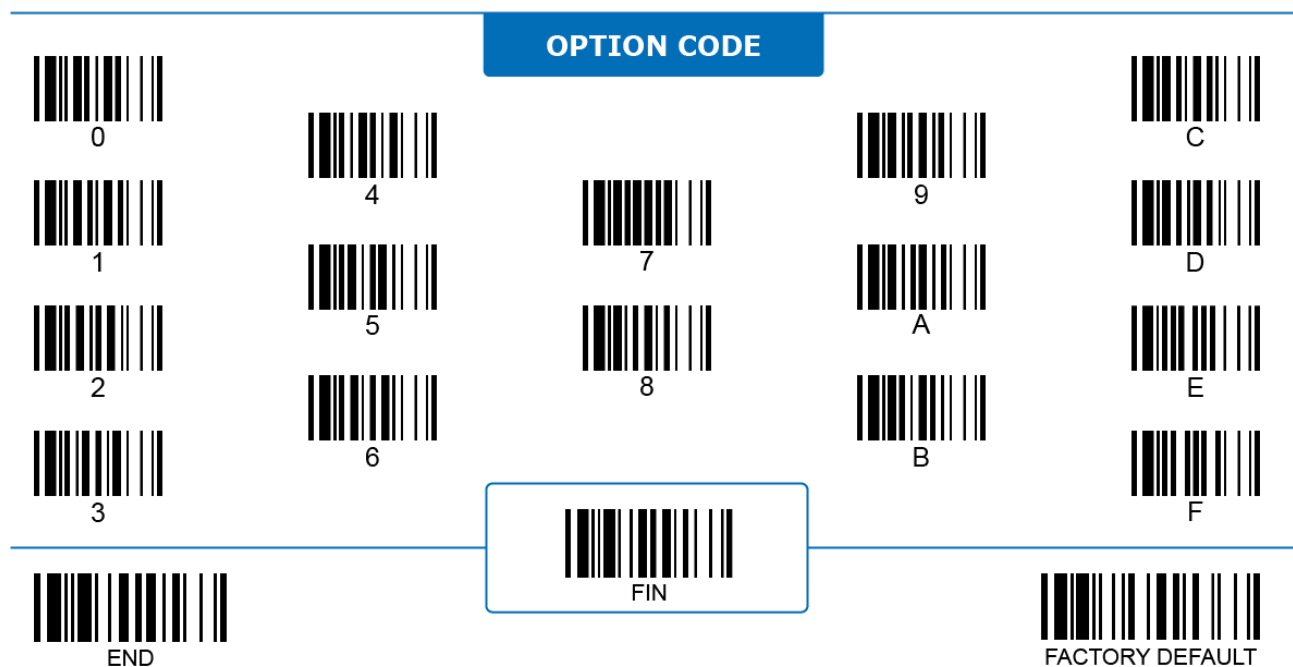

HID Keyboard Interface

Key Pad Emulation



Program

ALL

Family Code	PP	Parameter Selection	Option Code
 Key Pad Emulation	SS	Disable ◀	0
	SS	Enable	1

Key Pad Emulation: When enabled, the scanner outputs numeric characters as keystrokes on the key pad when the Num Lock is on. When disabled, it outputs numeric characters as keystrokes on the typewriter keys. This function is **only** available with IBM PP/AT, PS/VP, PS/2 series personal computers and compatible machines.

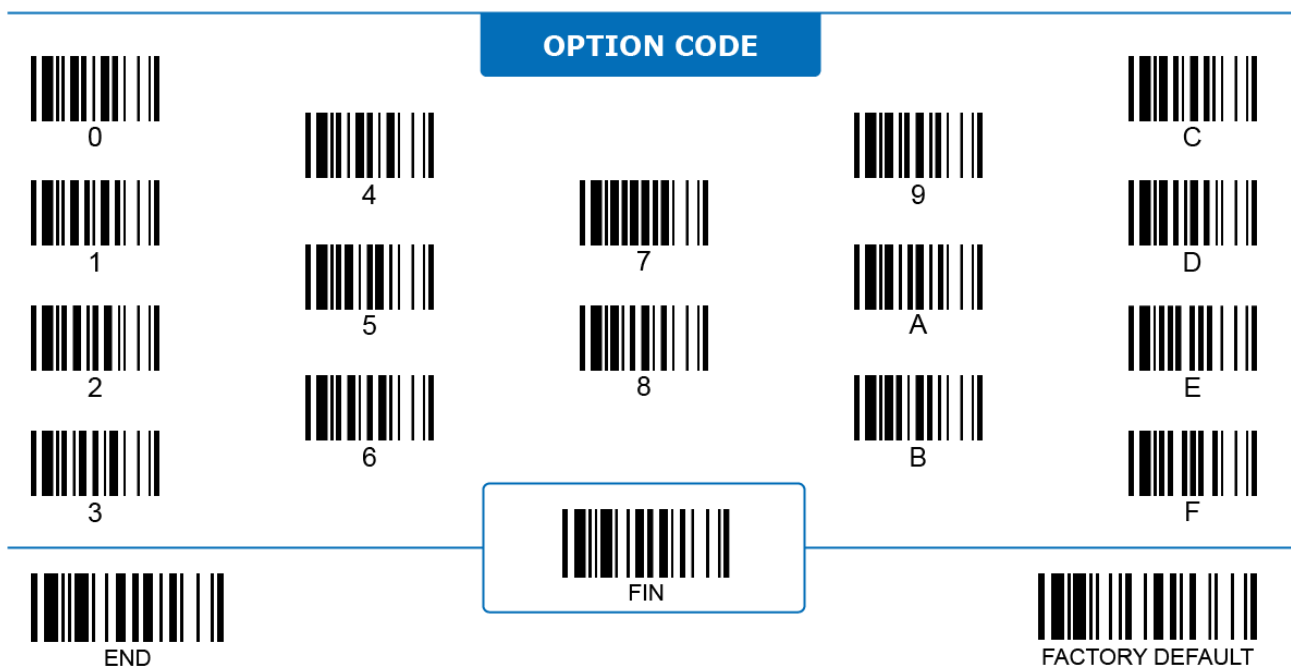

HID Keyboard Interface

Keyboard Upper/Lower Case



Program

ALL

Family Code	PP	Parameter Selection	Option Code
<p>Keyboard Upper/Lower Case</p>	SS	Normal case ◀	0
	SS	Inverse case	1
	SS	Upper case	2
	SS	Lower case	3

Keyboard Upper/Lower Case controls whether the output character(s) are in upper or lower case when the scanner is in:

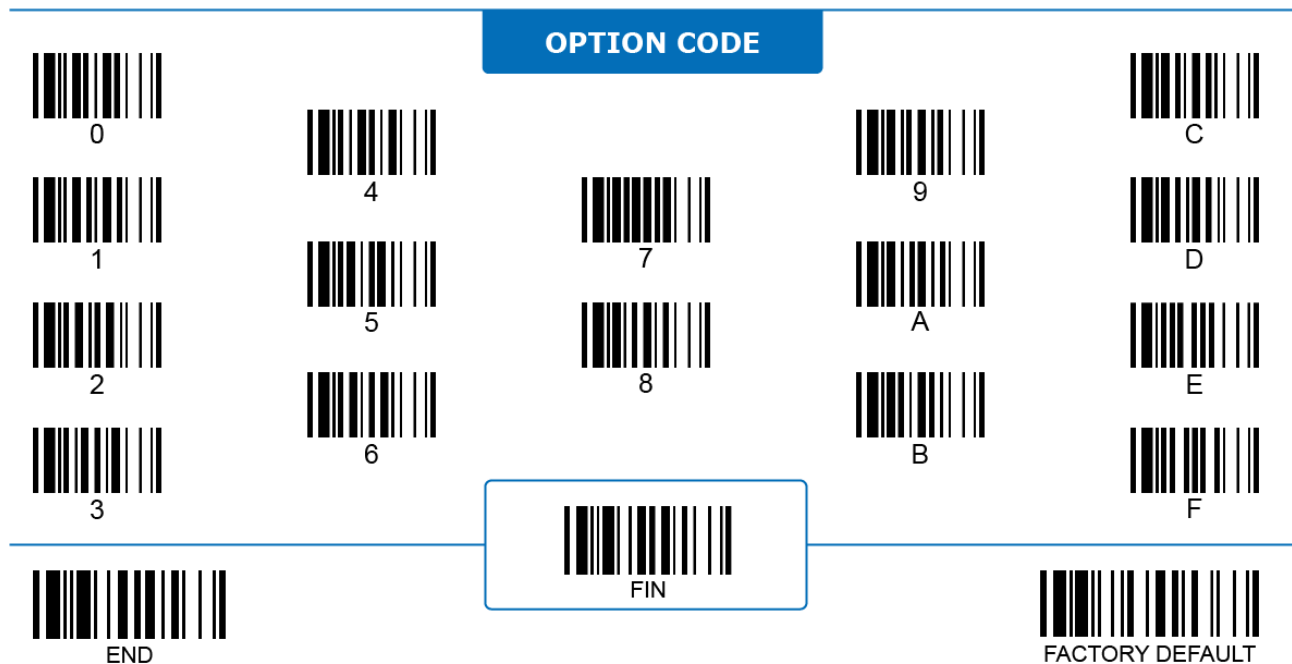

- i. **Normal case:** The scanner transmits every data character in its original font case.
- ii. **Inverse case:** The scanner alters the font case of every data character from upper case to lower case or from lower case to upper case before transmitting it out.
- iii. **Upper case:** The scanner transmits every data character in upper case regardless of its original font case.
- iv. **Lower case:** The scanner transmits every data character in lower case regardless of its original font case.

Be aware that **Caps Lock** is still effective with Keyboard Upper/Lower Case function. In other word, if Caps Lock is ON on the host keyboard, the output font case should be inversed to the font case mentioned in above options.























ALL

Family Code	PP	Parameter Selection	Option Code
 Intercharacter Delay	SS MS	None ◀ 1-99 (x5) ms After scanning the 2-digit code, the selection ends automatically.	FIN (2 digits)
 Intermessage Delay	SS MS	None ◀ 1-99 (x5) ms (All corded series) 1-99 (x10) ms (All Bluetooth series) After scanning the 2-digit code, the selection ends automatically.	FIN (2 digits)
 Interfunction Delay	SS MS	None ◀ 1-99 (x5) ms After scanning the 2-digit code, the selection ends automatically.	FIN (2 digits)

1. **Intercharacter Delay** is the time delay between characters transmitted by the scanner. This parameter is used to synchronize data communication when:
 - i. Data transmission speed is too fast, and characters may be skipped;
 - ii. Multitasking operation system or host computers in a network may slow down keyboard handling;
 - iii. Various notebook or desktop PC systems require different timing configurations.
 (Note: add one extra unit as safety margin when configuring this parameter.)
2. **Intermessage Delay** is the time delay between messages transmitted by the scanner. Increasing this delay will help host applications process the incoming data on time.
3. **Interfunction Delay** is the time delay between two data segments divided by a function character.
4. For the A and PA series Bluetooth scanners, Intermessage Delay, Intercharacter Delay, and Interfunction Delay functions are not available under SPP and Bluetooth HID modes.

OPTION CODE

 0	 4	 7	 9
 1	 5	 8	 A
 2	 6	 B	 C
 3		 FIN	 D
 END			 E
			 F
			 FACTORY DEFAULT

HID Keyboard Interface

Keyboard Country Layout



Program

ALL

Family Code	PP	Parameter Selection	Option Code
 <p>Keyboard Country Layout</p>	SS	USA (QWERTY) ◀	00
	SS	France (AZERTY)	01
	SS	Germany (QWERTZ)	02
	SS	United Kingdom - UK (QWERTY)	03
	SS	Canadian French (QWERTY)	04
	SS	Spain (Spanish, QWERTY)	05
	SS	Sweden/Finland (QWERTY)	06
	SS	Portugal (QWERTY)	07
	SS	Norway (QWERTY)	08
	SS	Spain (Latin America, QWERTY)	09
	SS	Italy (QWERTY)	10
	SS	Netherlands (QWERTY)	11
	SS	Denmark (QWERTY)	12
	SS	Belgium (AZERTY)	13
	SS	Swiss German (QWERTZ)	14
	SS	Iceland (QWERTY)	15
	SS	Japan (DOS/V)	16
	SS	Czech (QWERTY)	17
	SS	Universal	99

1. **Keyboard Country Layout** enables scanner to emulate keyboard output in different languages. To ensure the keyboard layout matches the language code page of the output data, it is necessary to set a correct corresponding code page using the **Keyboard Output Country Code Page** function.
2. Refer to **Appendix: Code Page - Table of Corresponding Languages** for details about the code page of each language.
3. When **Universal** keyboard layout is selected, ASCII characters are sent as a sequence of "Alt Code" outputs (Alt key + numeric keypad value). For example, the uppercase letter "A" is transmitted as "Alt + 0 6 5" in universal keyboard.
4. The Universal keyboard layout is only available for Windows OS.

OPTION CODE



0



4



7



9



C



1



5



8



A



D



2



6



B



E

3

FIN

F

END



FACTORY DEFAULT

Encoding Country Code Page



Program

2D ONLY

Family Code	PP	Parameter Selection		Option Code	
 <p>Encoding Country Code Page</p>	MS	UTF8	ISO 8859-1 Latin 1, West Euro	00	1E
	MS	Code page 950	ISO 8859-2 Latin 2, Central Euro	10	1F
	MS	Code page 949	ISO 8859-3 Latin 3, South Euro	11	20
	MS	Code page 936	ISO 8859-4 Latin 4, North Euro	12	21
	MS	Code page 932	ISO 8859-5 Cyrillic	13	22
	MS	Code page 874	ISO 8859-6 Arabic	14	23
	MS	WIN1250	ISO 8859-7 Greek	15	24
	MS	WIN1251	ISO 8859-8 Hebrew	16	25
	MS	WIN1252 ◀	ISO 8859-9 Latin 5, Turkish	17	26
	MS	WIN1253	ISO 8859-10 Latin 6, Nordic	18	27
	MS	WIN1254	ISO 8859-11 Thai	19	28
	MS	WIN1255	ISO 8859-13 Latin 7, Baltic	1A	29
	MS	WIN1256	ISO 8859-14 Latin 8, Celtic	1B	2A
	MS	WIN1257	ISO 8859-15 Latin 9	1C	2B
	MS	WIN1258	ISO 8859-16 Latin 10, SE Euro	1D	2C

1. **Encoding Country Code Page** configures which code page the scanner uses when decoding 2D barcodes. Make sure the decoding code page matches the original encoding code page for the correct output.
2. Refer to **Appendix: Code Page - Table of Corresponding Languages** for details about the code page of each language.
3. Select **UTF8** if the 2D barcode is encoded in Unicode (UTF8).

OPTION CODE



0



4



7



9



C



1



5



8



A



D



2



6



B



E



3

FIN

F

END

FIN

FACTORY DEFAULT

Keyboard Output Country Code Page



Program

ALL

Family Code	PP	Parameter Selection		Option Code	
<p>Keyboard Output Country Code Page</p>	MS	MAC Unicode	Code Page 855	01	31
	MS	WIN Notepad Unicode	Code Page 866	02	32
	MS	WIN WordPad Unicode	Code Page 850	03	33
	MS	Code Page 950	Code Page 437	10	34
	MS	Code Page 949	Code Page 737	11	35
	MS	Code Page 936	Code Page 857	12	36
	MS	Code Page 932	Code Page 862	13	37
	MS	Code Page 874	Code Page 720	14	38
	MS	WIN1250	Code Page 775	15	39
	MS	WIN1251	WIN1255	16	1A
	MS	WIN1252 ◀	WIN1256	17	1B
	MS	WIN1253	WIN1257	18	1C
	MS	WIN1254	WIN1258	19	1D
	MS	Code Page 852		30	

Keyboard Output Country Code Page controls which code page the scanner uses when it transmits the scanned data. For correct output, make sure the output format matches the decoding format (**Encoding Country Code Page**) and language setting of the operating system on the host device.

- i. **Mac Device output:** Select “MAC Unicode Output” on the scanner, and select “Unicode Hex Input” as the input format on the MAC device with a 16-bit input setup. See **Appendix: Code Page - Unicode Hex Input Setup** for the setup process.
- ii. **WIN Notepad Unicode output:** When outputting Unicode barcodes to Notepad, select “Unicode Hex Input” and set English (United States) as the system language on the host device. See **Appendix: Code Page - Unicode Hex Input Setup** for the setup process.
- iii. **WIN WordPad Unicode output:** When outputting Unicode barcodes to WordPad, set English (United States) as the system language on the host device.

OPTION CODE

0

4

7

9

C

1

5

8

A

D

2

6

B

E

3

FIN

F

END

FIN

FACTORY DEFAULT

HID Keyboard Interface

User-defined Function Key



Program

2D ONLY

Family Code	PP	Parameter Selection	OC 1	OC 2
<p>User-defined Function Key</p>	DS	Set output character [OC2] to value [OC1] Refer to Appendix – Function Key Character Table for a complete list of selectable characters. Refer to Appendix – Function Key Output Table for the default characters of the 32 Function Keys.	[00-1F]	(4 digits)

User-defined Function Key enables the scanner to transmit special characters not defined in standard ASCII table. Follow the step below to output the desired characters:

- Refer to **Appendix – Function Key Character Table**, choose a special character from the table, and assign its corresponding **4-digit Option Code** to any of the 32 function key slots with hex value identifiers between 00 and 1F. For example, scan [User-defined Function Key] [00] [003A] to assign function key character “F1” to slot 00.
- The scanner can transmit the special character you defined when it reads a barcode containing the data value you defined.
- Or you can enter the defined special character in the same way as you may enter other standard ASCII characters.
- It is highly recommended to use the **PowerTool 3** software utility to set the Function Keys.

To enter the character(s), refer to the **HEX to ASCII Conversion Table** below. The characters inside the highlighted area are changeable by **User-defined Function Key**.

L \ H	0	1	2	3	4	5	6	7
0	NUL	DLE	SPACE	0	@	P	`	p
1	SOH	DC1	!	1	A	Q	a	q
2	STX	DC2	*	2	B	R	b	r
3	ETX	DC3	#	3	C	S	c	s
4	EOT	DC4	\$	4	D	T	d	t
5	ENQ	NAK	%	5	E	U	e	u
6	ACK	SYN	&	6	F	V	f	v
7	BEL	ETB	'	7	G	W	g	w
8	BS	CAN	(8	H	X	h	x
9	HT	EM)	9	I	Y	i	y
A	LF	SUB	*	:	J	Z	j	z
B	VT	ESC	+	;	K	[k	{
C	FF	FS	,	<	L	\	l	
D	CR	GS	-	=	M]	m	}
E	SO	RS	.	>	N	^	n	~
F	SI	US	/	?	O	_	o	DEL

OPTION CODE

0

4

7

9

C

1

5

A

D

2

6

B

E

3

FIN

F

END

FIN

FACTORY DEFAULT

HID Keyboard Interface

USB Data Merge



Program

2D ONLY

Family Code	PP	Parameter Selection	Option Code
 USB Data Merge	SS	Disable ◀	0
	SS	Enable	1

USB Data Merge: When enabled, the decoded characters of the same barcode can be packed into fewer data packets to increase transmitting speed. Be aware that enabling data merge may lead to higher data loss possibility. Disable this function if you have connection difficulties.

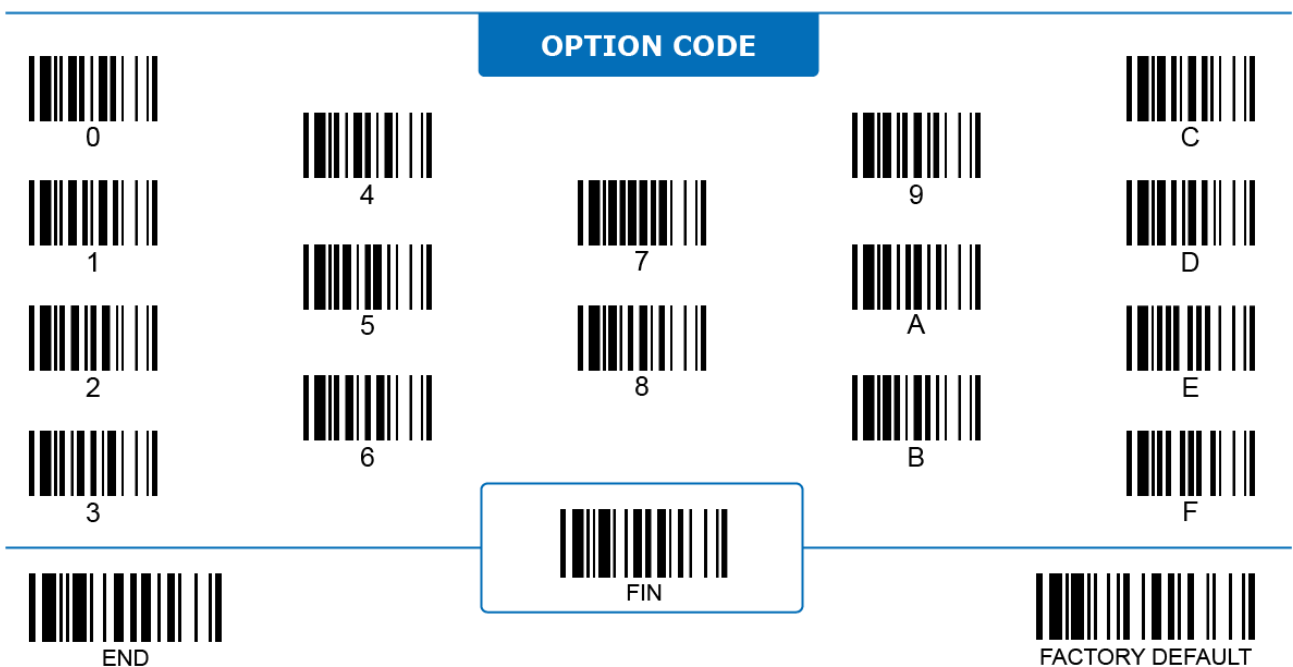

Serial Interface

Serial STX/ETX Transmit



Program

ALL

Family Code	PP	Parameter Selection	Option Code
 Serial STX/ETX Transmit	SS	Disable ◀	0
	SS	Enable	1

Serial STX/ETX Transmit: When enabled, the scanner transmits invisible STX and ETX characters under the serial interface. STX and ETX are characters used to indicate the start and end of a total data frame.

The table below shows the complete **Serial Interface Message String** (RS232, USB COM) :

STX	Preamble	Data Length	Prefix Code ID	Scanned Data	Suffix Code ID	Postamble	ETX	Record Suffix
1char.	1-15 characters	2-4 digits	1 or 3 characters	Variable length	1 or 3 characters	1-15 characters	1 char	1 character

OPTION CODE





ALL

Family Code	PP	Parameter Selection	Option Code
<p>Intermessage Delay</p>	SS None ◀ MS 1-99 (x5) ms (All corded series) MS 1-99 (x10) ms (All Bluetooth series)	After scanning the 2-digit code, the selection ends automatically.	FIN (2 digits)
<p>Intercharacter Delay</p>	SS None ◀ MS 1-99 (x5) ms	After scanning the 2-digit code, the selection ends automatically.	FIN (2 digits)
<p>Interfunction Delay</p>	SS None ◀ MS 1-99 (x5) ms	After scanning the 2-digit code, the selection ends automatically.	FIN (2 digits)

- Intercharacter Delay** is the time delay between characters transmitted by the scanner. This parameter is used to synchronize data communication when:
 - Data transmission speed is too fast, and characters may be skipped;
 - Multitasking operation system or host computers in a network may slow down keyboard handling;
 - Various notebook or desktop PC systems require different timing configurations.

(Note: add one extra unit as safety margin when configuring this parameter.)
- Intermessage Delay** is the time delay between messages transmitted by the scanner. Increasing this delay will help host applications process the incoming data on time.
- Interfunction Delay** is the time delay between two data segments divided by a function character.
- For the A and PA series Bluetooth scanners, Intermessage Delay, Intercharacter Delay, and Interfunction Delay functions are not available under SPP and Bluetooth HID modes.

OPTION CODE

0

4

7

9

C

1

5

8

A

D

2

6

B

E

3

FIN

F

END

FIN

FACTORY DEFAULT



ALL

Family Code	PP	Parameter Selection	Option Code
<p>Serial Handshaking Protocol</p>	SS	None ◀	0
	SS	RTS/CTS hardware handshaking	1
	SS	ACK/NAK software handshaking	2
	SS	XON/XOFF software handshaking	3

1. **Serial Handshaking Protocol** configures which protocol the scanner adapts to communicate with the host device.
 - i. **None:** When selected, the scanner transmits data whenever it decodes a barcode.
 - ii. **RTS/CTS hardware handshaking:** When selected, the scanner sends out RTS (request to send) and CTS (clear to send) signals before normal data communication begins. This protocol can ensure the reliability of data transmission.
 - iii. **ACK/NAK software handshaking:** When selected, the scanner waits for an ACK (acknowledgement) or NAK (negative acknowledgement) character sent from the host device after each data transmission. If it receives a NAK, the scanner re-sends the data until receiving an ACK.
 - iv. **XON/XOFF software handshaking:** When selected, the scanner waits for an XON (transmit on) or XOFF (transmit off) character sent from the host device after each data transmission.
2. USB CDC/Virtual COM does not support the RTS/CTS handshaking protocol.
3. For A, F, L, and PA, PF, PL series Bluetooth models, the ACK/NAK handshaking protocol is available with:
 - i. Pair mode, using RS232 or USB CDC/Virtual COM interface.
 - ii. SPP master or slave mode.

OPTION CODE

 0	 4	 7	 C
 1	 5	 9	 D
 2	 6	 A	 E
 3	 FIN	 B	 F

END

FACTORY DEFAULT

Serial Interface

Serial Response Timeout, Baud Rate, Data Frame



Program

ALL

Family Code	PP	Parameter Selection		Option Code	
 Serial Response Timeout	SS	None	3 sec	0	6
	SS	200 ms	4 sec	1	7
	SS	500 ms ◀	5 sec	2	8
	SS	800 ms	8 sec	3	9
	SS	1 sec	10 sec	4	A
	SS	2 sec	15 sec	5	B
	 Serial Baud Rate	SS	38.4K BPS	2400 BPS	0
SS		19.2K BPS	1200 BPS	1	5
SS		9600 BPS ◀	57.6K BPS	2	8
SS		4800 BPS	115.2K BPS	3	9
 Serial Data Frame	SS	8, None, 1 ◀	7, Space, 1	0	8
	SS	8, Odd, 1	7, Mark, 1	1	9
	SS	8, Even, 1	7, None, 2	2	A
	SS	8, Space, 1	7, Odd, 2	3	B
	SS	8, Mark, 1	7, Even, 2	4	C
	SS	8, None, 2	7, Space, 2	5	D
	SS	7, Odd, 1	7, Mark, 2	6	E
	SS	7, Even, 1		7	

Serial Response Timeout configures the duration the scanner waits for an ACK or NAK response from the host device before it discards the decoded data and issues an error indication.

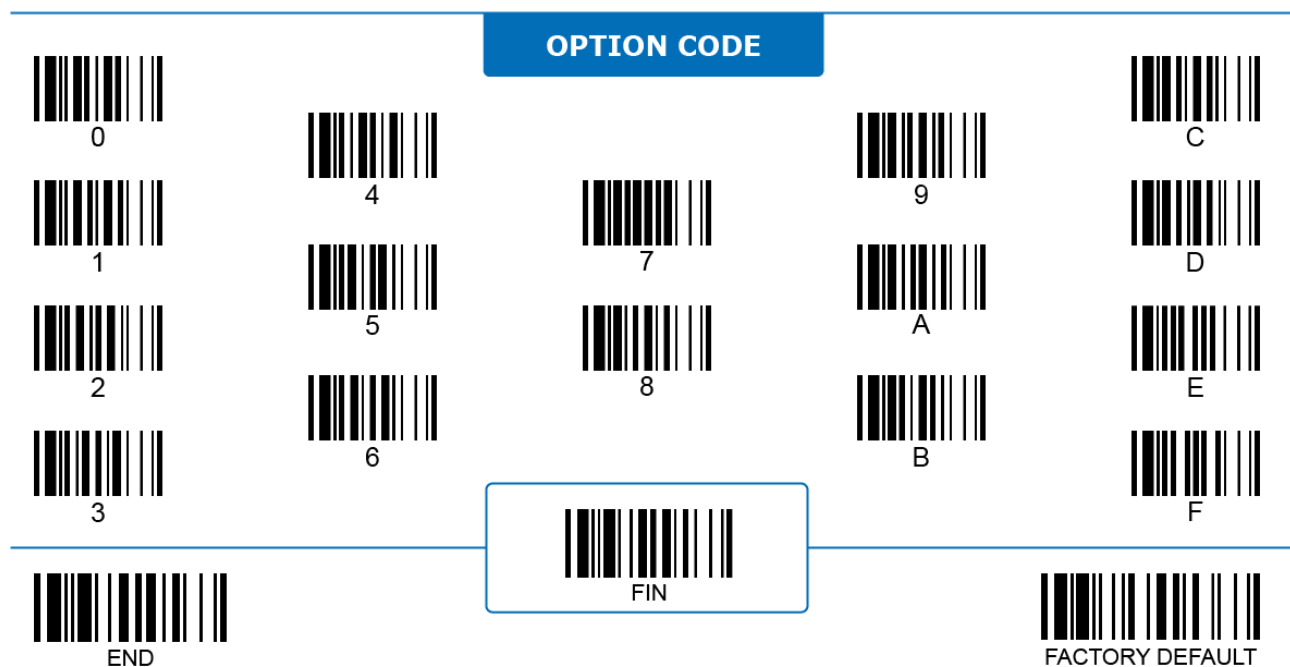

Serial Interface

Encoding Country Code Page

2D ONLY





















Program

Family Code	PP	Parameter Selection		Option Code	
 <p>Encoding Country Code Page</p>		UTF8	ISO 8859-1 Latin 1, West Euro	00	1E
		Code Page 950	ISO 8859-2 Latin 2, Central Euro	10	1F
		Code Page 949	ISO 8859-3 Latin 3, South Euro	11	20
		Code Page 936	ISO 8859-4 Latin 4, North Euro	12	21
		Code Page 932	ISO 8859-5 Cyrillic	13	22
		Code Page 874	ISO 8859-6 Arabic	14	23
		WIN1250	ISO 8859-7 Greek	15	24
	MS	WIN1251	ISO 8859-8 Hebrew	16	25
		WIN1252 ◀	ISO 8859-9 Latin 5, Turkish	17	26
		WIN1253	ISO 8859-10 Latin 6, Nordic	18	27
		WIN1254	ISO 8859-11 Thai	19	28
		WIN1255	ISO 8859-13 Latin 7, Baltic	1A	29
		WIN1256	ISO 8859-14 Latin 8, Celtic	1B	2A
		WIN1257	ISO 8859-15 Latin 9	1C	2B
		WIN1258	ISO 8859-16 Latin 10, SE Euro	1D	2C

1. **Encoding Country Code Page** configures which code page the scanner uses when decoding 2D barcodes. Make sure the decoding format matches the original encoding format for the correct output.
2. Refer to **Appendix: Code Page - Table of Corresponding Languages** for details about the code page of each language.
3. Select **UTF8** if the 2D barcode is encoded in Unicode (UTF8).

OPTION CODE

 0	 4	 7	 9	 C
 1	 5	 8	 A	 D
 2	 6	 B	 E	 F
 3	<div style="border: 1px solid blue; padding: 5px; display: inline-block;">  FIN </div>		 END	 FACTORY DEFAULT

Serial Interface

Serial Output Country Code Page

2D ONLY





Program

Family Code	PP	Parameter Selection		Option Code	
 <p>Serial Output Country Code Page</p>	MS	Raw data ◀	WIN1257	00	1C
		Unicode (Big Endian)	WIN1258	01	1D
		Unicode (Little Endian)	Code Page 852	02	30
		UTF8	Code Page 855	03	31
		Code Page 950 (Big Endian)	Code Page 866	10	32
		Code Page 949 (Big Endian)	Code Page 850	11	33
		Code Page 936 (Big Endian)	Code Page 437	12	34
		Code Page 932 (Big Endian)	Code Page 737	13	35
		Code Page 874	Code Page 857	14	36
		WIN1250	Code Page 862	15	37
		WIN1251	Code Page 720	16	38
		WIN1252	Code Page 775	17	39
		WIN1253	Code Page 950 (Little Endian)	18	90
		WIN1254	Code Page 949 (Little Endian)	19	91
		WIN1255	Code Page 936 (Little Endian)	1A	92
		WIN1256	Code Page 932 (Little Endian)	1B	93

Serial Output Country Code Page configures the data format which the scanner uses when it transmits the decoded data. For correct output in the desired language, make sure this setting matches the original encoding format (**Encoding Country Code Page**).

OPTION CODE



0



4



7



9



C



1



5



8



A



D



2



6



B



E

3

FIN

F

END

FACTORY DEFAULT

Serial Interface

Serial NAK Retry Count



Program

ALL

Family Code	PP	Parameter Selection	Option Code
 Serial NAK Retry Count	SS	3 times ◀	FIN
	SS	Disable	000
	SS	1~254 times	(3 digits)
	SS	Retry unlimited times	255

- Serial NAK Retry Count** configures how many times the scanner resends decoded data when it sends out the data but receives a NAK response afterward. The scanner issues an error indication and discards decoded data if:
 - The retry count which the scanner has sent reaches the limit set by Serial NAK Retry Count.
 - The preset **Serial Response Timeout** is up before the NAK retry count reaches its limit.
 When disabled, the scanner discards the decoded data once it receives a NAK.
- For the A, F, L, PA, PF, and PL series Bluetooth scanners, Serial NAK Retry Count is not available with Batch Scanning mode. Enabling NAK Retry Count automatically disables out-of-range scanning under online (normal) scanning mode.

OPTION CODE



0



4



7



9



C



1



5



8



A



D



2



6



B



E

3

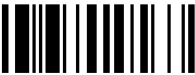
FIN

F

END

FACTORY DEFAULT

Serial Interface

Serial ACK Indication



Program

ALL

Family Code	PP	Parameter Selection	Option Code
 Serial ACK Indication	SS	Disable ACK indication; disable ACK timeout indication	0
	SS	Disable ACK indication; enable ACK timeout indication ◀	1
	SS	Enable ACK indication; disable ACK timeout indication	2
	SS	Enable ACK indication; enable ACK timeout indication	3

1. **Serial ACK Timeout Indication:** When enabled, the scanner emits LED and beeping indications once the Serial Response Timeout is up.
2. **Serial ACK Indication:** When enabled, the scanner emits LED and beeping indications once it receives an ACK.

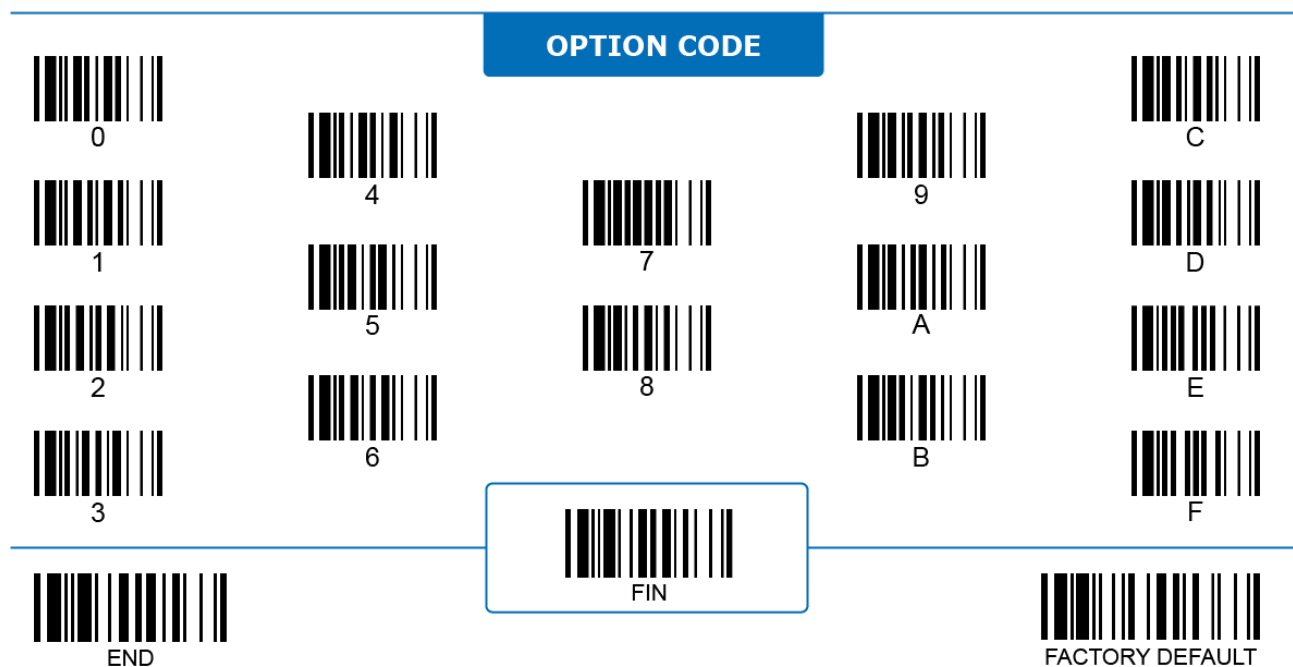

3 BARCODE READING

The parameters contained in this chapter will help users set up their scanners to read different types of barcodes supported by FuzzyScan scanners. The corresponding detailed settings of each code type are also collected in this chapter. Users can enable the Barcode ID function to identify the type of code scanned.

Code ID

Code ID Transmit



Program

ALL

Family Code	PP	Parameter Selection	Option Code
 Code ID Transmit	SS	Disable ◀	0
	SS	Transmit Cino ID as prefix	1
	SS	Transmit Cino ID as suffix	2
	SS	Transmit Cino ID as prefix and suffix	3
	SS	Transmit AIM ID as prefix	4
	SS	Transmit AIM ID as suffix	5
	SS	Transmit AIM ID as prefix and suffix	6

Code ID Transmit: When enabled, the scanner sends out an ID alongside the data value to identify the type of scanned barcode. Code ID can be transmitted either as a prefix, a suffix, or both. Refer to **Appendix – Code ID Table** for a complete list of Cino code ID or AIM code ID.

The table below shows the complete Message String:

(STX)	Preamble	(Data Length)	Prefix Code ID	Scanned Data	Suffix Code ID	Postamble	(ETX)	Record Suffix
(1char.)	1-15 characters	(2-4 digits)	1 or 3 characters	Variable length	1 or 3 characters	1-15 characters	(1 char)	1 character

STX/ETX and Data Length are only outputted under Serial Interfaces (RS232, USB COM).

OPTION CODE



Code ID

Code ID – 1 Character



Program

ALL

Family Code	PP	Parameter Selection	OC1	OC2	PP	Parameter Selection	OC1	OC2
 <p>Code ID - 1 char. -</p>	DS	Code 128 (B)	00	1 ch	DS	China Postal Code (L)	10	1 ch
	DS	GS1 128 (C)	01	1 ch	DS	German Postal Code (M)	11	1 ch
	DS	UPC A (A)	02	1 ch	DS	IATA (O)	12	1 ch
	DS	EAN 13 (F)	03	1 ch	DS	Code 11 (P)	13	1 ch
	DS	Codabar (D)	04	1 ch	DS	MSI (R)	14	1 ch
	DS	Code 39/Code 32 (G)	05	1 ch	DS	UK/Plessey (S)	15	1 ch
	DS	Code 93 (H)	06	1 ch	DS	Telepen (T)	16	1 ch
	DS	Industrial 25 (I)	07	1 ch	DS	GS1 DataBar (X)	17	1 ch
	DS	Interleaved 25 (J)	08	1 ch	DS	UPC E (E)	18	1 ch
	DS	Matrix 25 (K)	09	1 ch	DS	EAN 8 (N)	19	1 ch

Code ID – 1 Character replaces the 1-character Cino Code ID from its default to the user-defined value.

To scan the 2nd option code, refer to the **HEX to ASCII Conversion Table** below:

L \ H	0	1	2	3	4	5	6	7
0	NUL	DLE	SPACE	0	@	P	`	p
1	SOH	DC1	!	1	A	Q	a	q
2	STX	DC2	*	2	B	R	b	r
3	ETX	DC3	#	3	C	S	c	s
4	EOT	DC4	\$	4	D	T	d	t
5	ENQ	NAK	%	5	E	U	e	u
6	ACK	SYN	&	6	F	V	f	v
7	BEL	ETB	'	7	G	W	g	w
8	BS	CAN	(8	H	X	h	x
9	HT	EM)	9	I	Y	i	y
A	LF	SUB	*	:	J	Z	j	z
B	VT	ESC	+	;	K	[k	{
C	FF	FS	,	<	L	\	l	
D	CR	GS	-	=	M]	m	}
E	SO	RS	.	>	N	^	n	~
F	SI	US	/	?	O	_	o	DEL

OPTION CODE



0



4



7



9



C



1



5



8



A



D



2



6



B



E

3

FIN

F

END

FACTORY DEFAULT

Code ID

Code ID – 1 Character (Continued)



Program

ALL

Family Code	PP	Parameter Selection	OC1	OC2	PP	Parameter Selection	OC1	OC2
 Code ID - 1 char. -	DS	Trioptic Code 39 (W)	20	1 ch	DS	Australian Post (g)	33	1 ch
	DS	UCC Coupon Ext. Code (Z)	21	1 ch	DS	British Post (h)	34	1 ch
	DS	PDF417/Micro PDF417 (V)	22	1 ch	DS	Intelligent Mail (USPS 4CB) (j)	36	1 ch
	DS	Korea Post Code (a)	26	1 ch	DS	Japan Post (k)	37	1 ch
	DS	QR/Micro QR Code (b)	28	1 ch	DS	Netherlands KIX Post (l)	38	1 ch
	DS	Data Matrix (c)	29	1 ch	DS	US Planet (m)	39	1 ch
	DS	Maxi Code (d)	30	1 ch	DS	US Postnet (o)	41	1 ch
	DS	Aztec Code (e)	31	1 ch	DS	Posi LAPA code (q)	43	1 ch

To scan the 2nd option code, refer to the **HEX to ASCII Conversion Table** below:

L \ H	0	1	2	3	4	5	6	7
0	NUL	DLE	SPACE	0	@	P	`	p
1	SOH	DC1	!	1	A	Q	a	q
2	STX	DC2	*	2	B	R	b	r
3	ETX	DC3	#	3	C	S	c	s
4	EOT	DC4	\$	4	D	T	d	t
5	ENQ	NAK	%	5	E	U	e	u
6	ACK	SYN	&	6	F	V	f	v
7	BEL	ETB	'	7	G	W	g	w
8	BS	CAN	(8	H	X	h	x
9	HT	EM)	9	I	Y	i	y
A	LF	SUB	*	:	J	Z	j	z
B	VT	ESC	+	;	K	[k	{
C	FF	FS	,	<	L	\	l	
D	CR	GS	-	=	M]	m	}
E	SO	RS	.	>	N	^	n	~
F	SI	US	/	?	O	_	o	DEL

OPTION CODE



0



4



7



9



C



1



5



8



A



D



2



6



B



E

3

FIN

F

END

FACTORY DEFAULT

Barcode Readability

Readable Barcode Settings



Program

ALL

Family Code	PP	Parameter Selection	Option Code
 <p>Readable Barcode</p> <div style="border: 1px solid black; padding: 5px; width: fit-content;"> Entering "Auto" ends the process automatically. For other options, scan "FIN" to end the process. </div>	SS	CS Auto ◀	MSI 00 11
	CS	CS Popular 1D	UK/Plessey C0 12
	CS	CS Code 128 *	Telepen 01 13
	CS	CS GS1 128 *	GS1 DataBar * 31 14
	CS	CS UPC A *	IATA 02 15
	CS	CS UPC E *	PDF417 * / Micro PDF417 03 17
	CS	CS EAN 13 *	Korea Post Code 04 21
	CS	CS EAN 8 *	QR Code * / Micro QR Code * 05 A0
	CS	CS Codabar *	Data Matrix * 06 A1
	CS	CS Code 39 *	MaxiCode 07 A2
	CS	CS Trioptic Code 39	Aztec Code * 47 A3
	CS	CS Industrial 25	Australian Post 08 B0
	CS	CS Matrix 25	British Post 38 B1
	CS	CS Interleaved 25 *	Intelligent Mail 48 B3
	CS	CS China Postal Code	Japan Post 58 B4
	CS	CS German Postal Code	KIX Post 68 B5
	CS	CS Code 93 *	US Planet Code 09 B6
	CS	CS Code 11	US Postnet 10 B8

Readable Barcode Settings configures which code type(s) can be recognized and decoded by the scanner. Limiting readable barcode types can improve reading speed and lower the possibility of reading errors.

- i. **Auto:** When selected, the scanner only reads most commonly used 1D and 2D barcode types marked with asterisk in the table above.
- ii. **Popular 1D:** When selected, the scanner only reads most commonly used 1D barcodes including Code 128, GS1 128, UPC A, UPC E, EAN 13, EAN 8, Codabar, Code 39, Interleaved 25, Code 93, and GS1 DataBar.

OPTION CODE



0



4



7



9



C



1



5



8



A



D



2



6



B



E

3

FIN

F

END

FACTORY DEFAULT



Barcode Settings

Code 39/32, Trioptic Code 39



Program

ALL

Family Code	PP	Parameter Selection	Option Code
 Code 39/32 Readability	SS	Disable	0
	SS	Enable ◀	1
 Trioptic C39 Readability	SS	Disable ◀	0
	SS	Enable	1

1. Only supports **Trioptic Code 39** with 6 characters.
2. **DO NOT** select “Full ASCII Code 39” in **Code 39 Primary Format** when enabling Trioptic Code 39.

OPTION CODE



0



4



7



9



C



1



5



8



A



D



2



6



B



E

3

FIN

F

END

FACTORY DEFAULT

Barcode Settings

Code 39



Program

ALL

Family Code	PP	Parameter Selection	Option Code
 <p>C39 Primary Format</p>	SS	Standard Code 39 ◀	2
	SS	Full ASCII Code 39	3
	SS	Code 32 (PARAF, Italian Pharmaceutical)	4

Code 39 Primary Format configures which type of Code 39 the scanner recognizes:

- i. **Standard Code 39:** When selected, the scanner decodes Code 39 with standard character set consisting of numeric digits 0 - 9, uppercase letters A - Z, and special characters including the percent sign (%), plus sign (+), dollar sign (\$), slash (/), period (.) and hyphen (-).
- ii. **Full ASCII Code 39:** When selected, the scanner decodes Code 39 with all 128 ASCII characters. The scanner treats certain pairs of special character and alphabet as a single ASCII character and transmits it. **Do not** enable Trioptic Code 39 with this option.
- iii. **Code 32:** When selected, the scanner decodes Code 39 following the coding rule of Code 32 (also known as PARAF) which is used by the Italian pharmaceutical industry.

OPTION CODE



0



4



7



9



C



1



5



8



A



D



2



6



B



E

3

FIN

F

END

FACTORY DEFAULT



Barcode Settings

Code 39





















Program

ALL

Family Code	PP	Parameter Selection	Option Code
 <p>C39 Start/Stop Transmit</p>	SS	Disable ◀	5
	SS	Enable	6
 <p>C32 Leading A Transmit</p>	SS	Disable ◀	7
	SS	Enable	8

- Code 39 Start/Stop Transmit:** When enabled, the scanner transmits additional asterisk (*) characters to mark the beginning and the end of a Code 39.
- Code 32 Leading A Transmit:** When enabled, the scanner transmits the leading character "A" which is normally skipped.

OPTION CODE

 0	 4	 7	 9	 C
 1	 5	 8	 A	 D
 2	 6	 B	 E	 F
 3	<div style="border: 1px solid blue; padding: 10px; display: inline-block;">  FIN </div>			 END
				 FACTORY DEFAULT



Barcode Settings

Code 39



Program

ALL

Family Code	PP	Parameter Selection	Option Code
 C39 Check Digit Verify	SS SS	Disable ◀ Enable	9 A
 C39 Check Digit Transmit	SS SS	Disable ◀ Enable	B C
 C39 Buffering	SS SS	Disable ◀ Enable	D E

- Code 39 Check Digit Verify:** When enabled, the scanner only decodes Code 39 conforming to the MOD 43 checksum rule.
- Code 39 Check Digit Transmit:** When enabled, the scanner transmits additional checksum digits that are normally skipped.
- Code 39 Buffering:** When enabled, the scanner temporarily stores multiple Code 39 data in its buffer memory and transmits the data all together. When disabled, the scanner transmits each Code 39 data immediately.

OPTION CODE



0



4



7



9



C



1



5



8



A



D



2



6



B



E



3

FIN

F

END

FIN

FACTORY DEFAULT



Barcode Settings

Code 39



Program

ALL

Family Code	PP	Parameter Selection	Option Code
 C39 Minimum Length	SS MS	Default (01) ◀ 01-Maximum <i>After scanning the 2-digit code, the selection ends automatically.</i>	FIN (2 digits)
 C39 Maximum Length	SS MS	Default (98) ◀ 98-Minimum <i>After scanning the 2-digit code, the selection ends automatically.</i>	FIN (2 digits)
 C39 Security Level	SS SS SS SS	Level 0 Level 1 Level 2 ◀ Level 3	0 1 2 3

- For **Code 39 Minimum Length** and **Maximum Length**, the data length excludes start/stop characters, such as the barcode ID.
- Code 39 Security Level** configures how well the scanner decodes poorly-printed or out-of-spec barcodes. Among the available levels, Level 1 is the most aggressive one and has the highest chance of a misread.

OPTION CODE



0



4



7



9



C



1



5



8



A



D



2



6



B



E



3

FIN

F

END

FIN

FACTORY DEFAULT





Barcode Settings

Code 93



Program

ALL

Family Code	PP	Parameter Selection	Option Code
 Code 93 Readability	SS SS	Disable Enable ◀	0 1
 C93 Check Digit Transmit	SS SS SS SS	Disable ◀ Enable	2 3
 C93 Minimum Length	SS MS	Default (01) ◀ 01-Maximum <i>After scanning the 2-digit code, the selection ends automatically.</i>	FIN (2 digits)
 C93 Maximum Length	SS MS	Default (98) ◀ 98-Minimum <i>After scanning the 2-digit code, the selection ends automatically.</i>	FIN (2 digits)

For Code 93 Minimum Length and Maximum Length, the data length excludes start/stop characters, such as the barcode ID.

OPTION CODE



0



4



7



9



C



1



5



8



A



D



2



6



B



E



3

FIN

F

END

FIN

FACTORY DEFAULT



Barcode Settings

Code 128



Program

ALL

Family Code	PP	Parameter Selection	Option Code
 Code 128 Readability	SS	Disable Code 128	0
	SS	Enable Code 128 ◀	1
 C128 ISBT Concatenate	SS	Disable ISBT Concatenation ◀	2
	SS	Enable ISBT Concatenation	3
	SS	Enable ISBT Concatenation with table check	4
	SS	Enable ISBT Concatenation Auto	5

Code 128 ISBT Concatenate configures how the scanner reacts when it reads International Society of Blood Transfusion (ISBT) barcodes.

- i. **Disable ISBT Concatenation:** The scanner does not transmit any ISBT concatenated barcodes.
- ii. **Enable ISBT Concatenation:** The scanner only decodes and transmits ISBT concatenated barcodes. The scanner does not decode any single (unconcatenated) ISBT barcode.
- iii. **Enable ISBT Concatenation with table check:** The scanner only decodes and transmits ISBT concatenated barcodes which conform to ICCBBA standards and are listed in the Standard Technical Specification check table. The scanner does not decode any single ISBT barcode or ISBT concatenated barcode not conforming to ICCBBA standards.
- iv. **Enable ISBT Concatenation Auto:** The scanner decodes and transmits both ISBT concatenated barcodes and single ISBT barcodes.

OPTION CODE



0



4



7



9



C



1



5



8



A



D



2



6



B



E

3

FIN

F

END

FACTORY DEFAULT



Barcode Settings

Code 128

ALL





Program

Family Code	PP	Parameter Selection	Option Code
 C128 Minimum Length	SS MS	Default (01) ◀ 01-Maximum <i>After scanning the 2-digit code, the selection ends automatically.</i>	FIN (2 digits)
 C128 Maximum Length	SS MS	Default (98) ◀ 98-Minimum <i>After scanning the 2-digit code, the selection ends automatically.</i>	FIN (2 digits)
 C128 Security Level	SS SS	Level 0 Level 1 ◀	0 1

- For **Code 128 Minimum Length** and **Maximum Length**, the data length excludes start/stop characters, such as the barcode ID.
- Code 128 Security Level** configures how the scanner decodes poorly-printed or out-of-spec barcodes. Level 1 is more aggressive and allows faster scanning with sufficient security while in decoding in-spec barcodes, while Level 0 is used for reading poorly-printed or out-of-spec barcodes or to avoid misreading.

OPTION CODE



0



4



7



9



C



1



5



8



A



D



2



6



B



E

3

FIN

F

END





FACTORY DEFAULT

Codabar



Program

ALL

Family Code	PP	Parameter Selection	Option Code
 Codabar Redability	SS	Disable	0
	SS	Enable ◀	1
 Codabar Primary Format	SS	Standard format ◀	2
	SS	ABC format	3
	SS	CLSI format	4
	SS	CX format	5
 Codabar Start/Stop Transmit	SS	Disable ◀	6
	SS	Transmit as ABCD/ABCD	7
	SS	Transmit as abcd/abcd	8
	SS	Transmit as ABCD/TN*E	9
	SS	Transmit as abcd/tn*e	A

1. **Codabar Primary Format** configures which Codabar format or concatenating rule the scanner follows.
2. **Codabar Start/Stop Transmit**: When enabled, the scanner converts the STX and ETX characters of a Codabar code into the selected format, and transmits them out with the decoded data.

OPTION CODE



0



4



7



9



C



1



5



8



A



D



2



6



B



E

3

FIN

F

END

FACTORY DEFAULT



Barcode Settings

Codabar





Program

ALL

Family Code	PP	Parameter Selection	Option Code
 Codabar Check Digit Verify	SS Disable ◀ SS Enable		B C
 Codabar Check Digit Select	SS Modulus 16 ◀ SS Modulus 10/Weight 3 SS Modulus 11 SS Modulus 10/Weight 2 SS 7 check DR SS Weight Modulus 11 SS Runes (Modulus 10/Weight 2)		0 1 2 3 4 5 6
 Codabar Check Digit Transmit	SS Disable ◀ SS Enable		D E

OPTION CODE



0



1



2



3



4



5



6



7



8



9



A



B



C



D

E

F

END

FIN

FACTORY DEFAULT



Barcode Settings

Codabar

ALL





















Program

Family Code	PP	Parameter Selection	Option Code
 Codabar Minimum Length	SS MS	Default (04) ◀ 01 to Maximum <i>After scanning the 2-digit code, the selection ends automatically.</i>	FIN (2 digits)
 Codabar Maximum Length	SS MS	Default (98) ◀ Minimum to 98 <i>After scanning the 2-digit code, the selection ends automatically.</i>	FIN (2 digits)

For **Codabar Minimum Length** and **Maximum Length**, the data length excludes start/stop characters, such as the barcode ID.

OPTION CODE

 0	 4	 7	 9	 C
 1	 5	 8	 A	 D
 2	 6	 FIN	 B	 E
 3			 F	
 END				 FACTORY DEFAULT





Barcode Settings

UPC



Program

ALL

Family Code	PP	Parameter Selection	Option Code
 UPC A Readability	SS SS	Disable Enable ◀	0 1
 UPC E Readability	SS SS	Disable Enable ◀	2 3
 UPC E Expansion	SS SS	Disable ◀ Enable	4 5
 UPC Standardization	SS SS	Disable ◀ Enable	6 7

- UPC E expansion:** When enabled, the decoded 8-digit UPC E is converted into a 12-digit UPC A and is affected by related settings, such as UPC standardization, UPC numeric system, and UPC A check digit transmission.
- UPC standardization:** When enabled, the scanner expands 12-digit UPC A into a 13-digit EAN 13 by inserting an extra zero.

WPC Selection (UPC/EAN/CAN)	Basic Length	Disable Check Digit	Disable Numeric System	With 2-digit Addendum	With 5-digit Addendum	Enable Standardization	Enable Expansion
UPC A	12	- 1	- 1	+ 2	+ 5	+ 1	0
UPC E	8	- 1	- 1	+ 2	+ 5	+ 1	+ 4
EAN 13	13	- 1	NC	+ 2	+ 5	NC	0
EAN 8	8	- 1	NC	+ 2	+ 5	NC	+ 5

OPTION CODE



0



4



7



9



C



1



5



8



A



D



2



6



B



E

3

FIN

F

END

FACTORY DEFAULT





Barcode Settings

UPC



Program

ALL

Family Code	PP	Parameter Selection	Option Code
 UPC Numeric System	SS SS	Disable Enable ◀	8 9
 UPC A Check Digit Transmit	SS SS	Disable Enable ◀	A B
 UPC E Check Digit Transmit	SS SS	Disable Enable ◀	C D
 UPC Leading Digit "1"	SS SS	Disable ◀ Enable	E F

UPC with leading digit "1": When enabled, the scanner recognizes and transmits UPC with "1" as its leading digit.

WPC Selection (UPC/EAN/CAN)	Basic Length	Disable Check Digit	Disable Numeric System	With 2-digit Addendum	With 5-digit Addendum	Enable Standardization	Enable Expansion
UPC A	12	- 1	- 1	+ 2	+ 5	+ 1	0
UPC E	8	- 1	- 1	+ 2	+ 5	+ 1	+ 4
EAN 13	13	- 1	NC	+ 2	+ 5	NC	0
EAN 8	8	- 1	NC	+ 2	+ 5	NC	+ 5

OPTION CODE



0



4



7



9



C



1



5



8



A



D



2



6



B



E

3

FIN

F

END

FACTORY DEFAULT



Barcode Settings

UPC



Program

ALL

Family Code	PP	Parameter Selection	Option Code
 <p>UPC Supplement Digits Select</p>	SS	Ignore supplement digits ◀	0
	SS	UPC with 2-digit supplement	1
	SS	UPC with 5-digit supplement	2
	SS	UPC with 2- or 5-digit supplement	3
 <p>UPC Supplement Digits Output</p>	SS	Disable ◀	4
	SS	Enable	5
 <p>UPC Addenda Separator</p>	SS	Disable ◀	6
	SS	Enable	7

- UPC Supplement Digits Select** configures which type of UPC code the scanner decodes according to its supplement digit format.
- UPC Supplement Digits Output:** When enabled, the scanner transmits the UPC type specified by **UPC Supplement Digit Select** together with its supplement digits.
- UPC Addenda Separator:** When enabled, the scanner inserts a space between the main UPC code and its supplement digits then transmits them out, if **UPC Supplement Digits Output** is enabled and the format type matches.

OPTION CODE



0



4



7



9



C



1



5



8



A



D



2



6



B



E



3

FIN

F

END

FIN

FACTORY DEFAULT



Barcode Settings

UPC





















Program

ALL

Family Code	PP	Parameter Selection		Option Code	
 UPC A Security Level	SS	Level 0		0	
	SS	Level 1 ◀		1	
	SS	Level 2		2	
 UPC Supplement Scan Voting	SS	None	Level 7	0	7
	SS	Level 1	Level 8	1	8
	SS	Level 2	Level 9	2	9
	SS	Level 3 ◀	Level 10	3	A
	SS	Level 4	Level 11	4	B
	SS	Level 5	Level 12	5	C
	SS	Level 6	Level 13	6	D

- UPC A Security Level** configures how the scanner decodes poorly-printed or out-of-spec UPC A barcodes. Level 2 is the most aggressive among the available levels. With it the scanner most easily decodes barcodes, but also most easily misreads barcodes, especially character numbers 1, 2, 7, and 8.
- UPC Supplement Scan Voting** is how many times an UPC/EAN with 2/5 supplement digits has to be decoded before output. Supplement Scan Voting is valid for UPC/EAN with only 2 supplement digits, UPC/EAN with only 5 supplement digits, or UPC/EAN with 2 or 5 supplement digits. Selecting a higher level might slow down the scanner when it reads poorly-printed, low contrast, or damaged barcodes.

OPTION CODE

 0	 4	 7	 9	 C
 1	 5	 8	 A	 D
 2	 6	 FIN	 B	 E
 3			 F	
 END			 FACTORY DEFAULT	



Barcode Settings

EAN



Program

ALL

Family Code	PP	Parameter Selection	Option Code
 EAN 13 Readability	SS	Disable	0
	SS	Enable ◀	1
 EAN 8 Readability	SS	Disable	2
	SS	Enable ◀	3
 EAN 8 Expansion	SS	Disable ◀	4
	SS	Enable	5

EAN 8 Expansion: When enabled, the scanner converts 8-digit EAN 8 to 13-digit EAN 13 and transmits it out.

WPC Selection (UPC/EAN/CAN)	Basic Length	Disable Check Digit	Disable Numeric System	With 2-digit Addendum	With 5-digit Addendum	Enable Standardization	Enable Expansion
UPC A	12	- 1	- 1	+ 2	+ 5	+ 1	0
UPC E	8	- 1	- 1	+ 2	+ 5	+ 1	+ 4
EAN 13	13	- 1	NC	+ 2	+ 5	NC	0
EAN 8	8	- 1	NC	+ 2	+ 5	NC	+ 5

OPTION CODE



0



4



7



9



C



1



5



8



A



D



2



6



B



E



3

FIN

F

END

FIN

FACTORY DEFAULT



Barcode Settings

EAN



Program

ALL

Family Code	PP	Parameter Selection	Option Code
 EAN 13 Check Digit Transmit	SS SS	Disable Enable ◀	6 7
 EAN 8 Check Digit Transmit	SS SS	Disable Enable ◀	8 9
 EAN ISBN/ISSN Convert	SS SS	Disable ◀ Enable	A B

EAN ISBN/ISSN Convert: When enabled, the scanner converts and transmits EAN codes to ISBN or ISSN formats according to their prefixes respectively.

WPC Selection (UPC/EAN/CAN)	Basic Length	Disable Check Digit	Disable Numeric System	With 2-digit Addendum	With 5-digit Addendum	Enable Standardization	Enable Expansion
UPC A	12	- 1	- 1	+ 2	+ 5	+ 1	0
UPC E	8	- 1	- 1	+ 2	+ 5	+ 1	+ 4
EAN 13	13	- 1	NC	+ 2	+ 5	NC	0
EAN 8	8	- 1	NC	+ 2	+ 5	NC	+ 5

OPTION CODE



0



4



7



9



C



1



5



8



A



D



2



6



B



E

3

FIN

F

END

FACTORY DEFAULT



Barcode Settings

EAN





















Program

ALL

Family Code	PP	Parameter Selection		Option Code	
 EAN 13 Security Level	SS	Level 0		0	
	SS	Level 1 ◀		1	
	SS	Level 2		2	
 EAN Supplement Scan Voting	SS	None	Level 7	0	7
	SS	Level 1	Level 8	1	8
	SS	Level 2	Level 9	2	9
	SS	Level 3 ◀	Level 10	3	A
	SS	Level 4	Level 11	4	B
	SS	Level 5	Level 12	5	C
	SS	Level 6	Level 13	6	D

- EAN 13 Security Level** configures how the scanner decodes poorly-printed or out-of-spec EAN 13 barcodes. Level 2 is the most aggressive among the available levels. With it the scanner most easily decodes barcodes, but also most easily misreads the barcodes, especially character numbers 1, 2, 7, and 8.
- EAN Supplement Scan Voting** is how many times an UPC/EAN with 2/5-digit supplement has to be decoded before being transmitted. Supplement Scan Voting is only valid for UPC/EAN with 2-digit, 5-digit, or 2/5-digit supplements. Selecting a higher level might slow down the scanner when it reads poorly-printed, low contrast, or damaged barcodes.

OPTION CODE

 0	 4	 7	 9	 C
 1	 5	 8	 A	 D
 2	 6	 B	 E	 F
 3	<div style="border: 1px solid blue; padding: 5px; display: inline-block;">  FIN </div>	 END	 FACTORY DEFAULT	

Barcode Settings

EAN



Program

ALL

Family Code	PP	Parameter Selection	Option Code
<p>EAN Supplement Digits Select</p>	SS	Ignore supplement digits ◀	0
	SS	EAN with 2-digit supplement	1
	SS	EAN with 5-digit supplement	2
	SS	EAN with 2- or 5-digit supplement	3
<p>EAN Supplement Digits Output</p>	SS	Disable ◀	4
	SS	Enable	5
<p>EAN Addenda Separator</p>	SS	Disable ◀	6
	SS	Enable	7

- EAN Supplement Digits Select** configures which type of EAN code the scanner decodes according to its supplement digit format.
- EAN Supplement Digits Output:** When enabled, the scanner transmits the EAN type that **EAN Supplement Digits Select** specifies together with its supplement digits.
- EAN Addenda Separator:** When enabled, the scanner inserts a space between the main EAN code and its supplement digits then transmits them out, if **EAN Supplement Digits Output** is enabled and the format type matches.

OPTION CODE

 0	 4	 7	 9	 C
 1	 5	 8	 A	 D
 2	 6	 B	 E	 F
 3	<div style="border: 1px solid blue; padding: 5px; display: inline-block;"> FIN </div>			 END
 FACTORY DEFAULT				

Barcode Settings

EAN



Program

ALL

Family Code	PP	Parameter Selection	Option Code
 <p>EAN Supplement Prefix</p>	SS	Ignore supplement digits ◀	0
	SS	Transmit supplemented EAN with all prefix types	1
	SS	Transmit supplemented EAN with prefix 491	2
	SS	Transmit supplemented EAN with prefix 978/979	3
	SS	Transmit supplemented EAN with prefix 977	4
	SS	Transmit supplemented EAN with prefix 378/379	5
	SS	Transmit supplemented EAN with prefix 414/419	6
	SS	Transmit supplemented EAN with prefix 434/439	7

EAN Supplement Prefix: When enabled, the scanner transmits EAN with supplement digits according to the prefix of the EAN. This function is only available when **EAN Supplement Digits Select** is set at **EAN with 2-digit supplement, EAN with 5-digit supplement, or EAN with 2- or 5-digit supplement:**

- i. **Ignore supplement digits:** When selected, the scanner decodes and transmits EAN codes without regarding its prefix and supplement.
- ii. **Transmit supplemented EAN with all prefix types:** When selected, the scanner decodes any EAN with the supplement without regarding its prefix.
- iii. **Transmit supplemented EAN with prefix 491:** When selected, the scanner transmits EAN starting with the number “491” if it has supplement digits. The scanner **DOES NOT** transmit EAN without supplement digits.
- iv. **Transmit supplemented EAN with prefix 978/979:** When selected, the scanner transmits EAN starting with the number “978” or “979” if it has supplement digits. The scanner **DOES** transmit EAN without supplement digits.
- v. **Transmit supplemented EAN with prefix 977:** When selected, the scanner transmits EAN starting with the number “977” if it has supplement digits. The scanner **DOES** transmit EAN without supplement digits.
- vi. **Transmit supplemented EAN with prefix 378/379:** When selected, the scanner transmits EAN starting with the number “378” or “379”. The scanner **DOES** transmits EAN without any supplement digits.
- vii. **Transmit supplemented EAN with prefix 414/419:** When selected, the scanner transmits EAN starting with the number “414” or “419”. The scanner **DOES** transmits EAN without any supplement digits.
- viii. **Transmit supplemented EAN with prefix 434/439:** When selected, the scanner transmits EAN starting with the number “434” or “439”. The scanner **DOES** transmits EAN without any supplement digits.

OPTION CODE



0



4



9



C



1



7



A



D



2



5



8



E



3



6

B

F

END

FIN

FACTORY DEFAULT

Barcode Settings

UCC Coupon Extended Code



Program

ALL

Family Code	PP	Parameter Selection	Option Code
 <p>UCC Coupon Extended Code Readability</p>	SS	Disable ◀	0
	SS	Enable	1

UCC Coupon Extended Code: When enabled, the scanner only decodes UPC A barcodes starting with the digit “5”, EAN 13 barcodes starting with the digit “99”, and GS1 128 Coupon Codes, if the reading of UPC A, EAN, and Code 128 has been enabled.

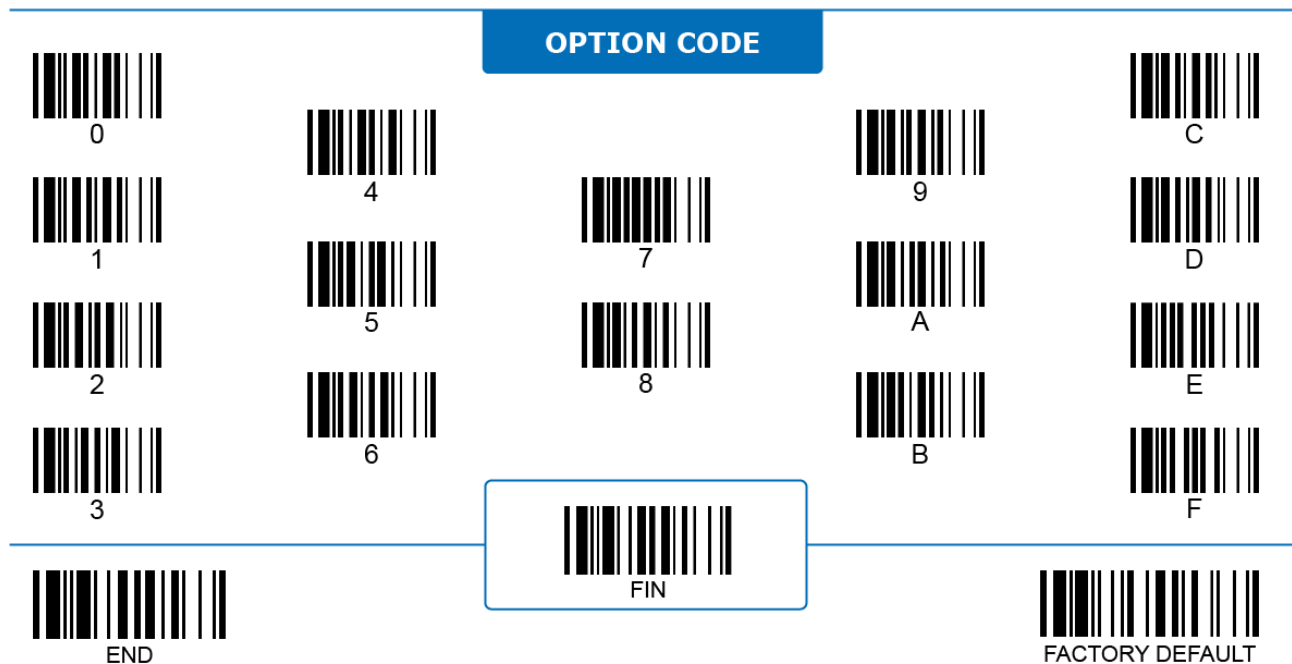



Barcode Settings

IATA

ALL





Program

Family Code	PP	Parameter Selection	Option Code
 IATA Readability	SS	Disable ◀	0
	SS	Enable	1
 IATA Checking Length	SS	15-digit fixed length checking	2
	SS	Variable length checking ◀	3

OPTION CODE



0



4



7



9



C



1



5



8



A



D



2



6



B



E

3

FIN

F

END

FACTORY DEFAULT



Barcode Settings

IATA

ALL





Program

Family Code	PP	Parameter Selection	Option Code
 IATA Check Digit Verify	SS	Disable ◀	4
	SS	Enable automatic check digit	5
	SS	Verify check digit on S/N only	6
	SS	Verify check digit on CPN only	7
	SS	Verify check digit on CPN, Airline, and S/N	8
 IATA Check Digit Transmit	SS	Disable ◀	9
	SS	Transmit check digit	A
 IATA Start/Stop Transmit	SS	Disable ◀	B
	SS	Transmit start/stop characters	C

IATA Start/Stop Transmit: When enabled, the scanner transmits STX and ETX characters together with the decoded data.

OPTION CODE



0



4



7



9



C



1



5



8



A



D



2



6



B



E



3

FIN

F

END

FIN

FACTORY DEFAULT





Barcode Settings

Interleaved 25 (ITF)



Program

ALL

Family Code	PP	Parameter Selection	Option Code
 Interleaved 25 Readability	SS	Disable	0
	SS	Enable ◀	1
 I25 Primary Format	SS	Interleaved 25 ◀	2
	SS	German Postal Code	3
 I25 Check Digit Verify	SS	Disable ◀	4
	SS	Verify with USS check digit	5
	SS	Verify with OPPC check digit	6
 I25 Check Digit Transmit	SS	Disable ◀	7
	SS	Transmit check digit	8

OPTION CODE





Barcode Settings

Code 25 Family



Program

ALL

Family Code	PP	Parameter Selection	Option Code
 Industrial 25 Readability	SS SS	Disable ◀ Enable	0 1
 Matrix 25 Readability	SS SS	Disable ◀ Enable	2 3
 China Postal Code Readability	SS SS	Disable ◀ Enable	4 5

Enable only one type of Code 25 at the same time, or set either maximum or minimum barcode length. Enabling multiple Code 25 types or allowing a changing data length might increase the chance of reading errors.

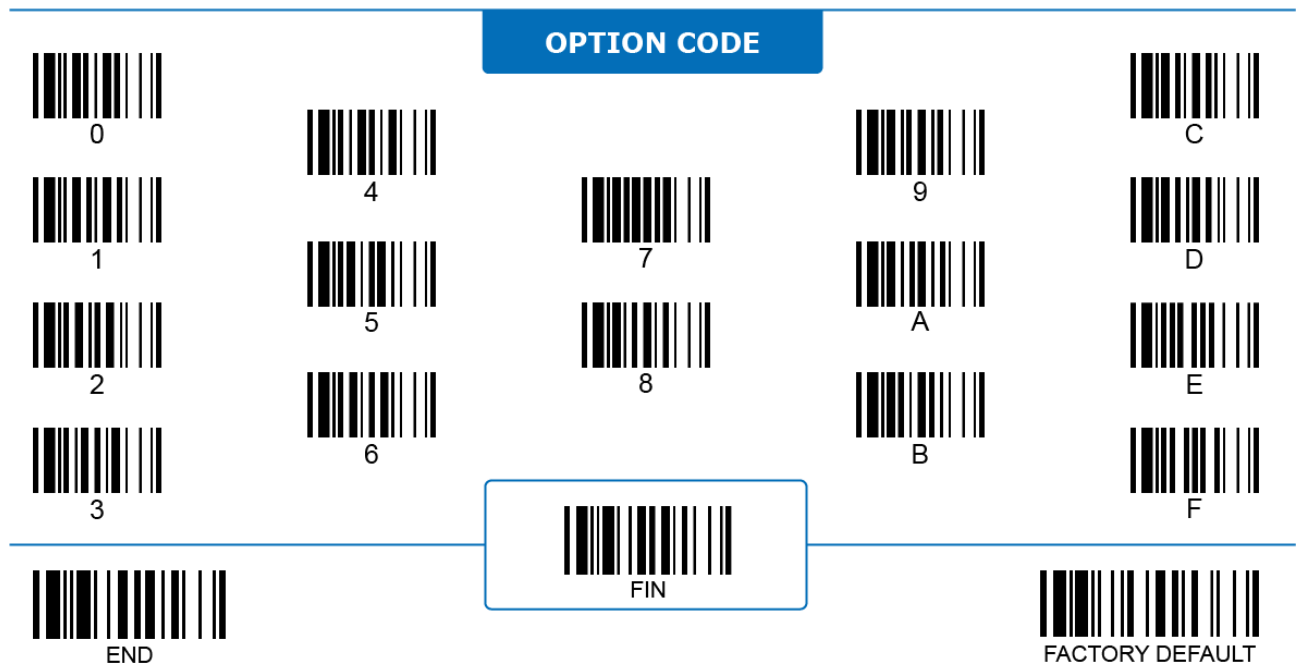



Barcode Settings
Code 25 Family





Program

ALL

Family Code	PP	Parameter Selection	Option Code
 Code 25 Check Digit Verify	SS	Disable ◀	6
	SS	Verify check digit	7
 Code 25 Check Digit Transmit	SS	Disable ◀	8
	SS	Transmit check digit	9

OPTION CODE



0



4



7



9



C



1



5



8



A



D



2



6



B



E



3

FIN

F

END

FIN

FACTORY DEFAULT



Barcode Settings

Code 25 Family



Program

ALL

Family Code	PP	Parameter Selection	Option Code
 <p>Code 25 Minimum Length</p>	SS MS	Default (04) ◀ 01-Maximum <i>After scanning the 2-digit code, the selection ends automatically.</i>	FIN (2 digits)
 <p>Code 25 Maximum Length</p>	SS MS	Default (98) ◀ 98-Minimum <i>After scanning the 2-digit code, the selection ends automatically.</i>	FIN (2 digits)

For Code 25 Minimum Length and Maximum Length, the data length excludes start/stop characters, such as the barcode ID.

OPTION CODE



0



4



7



9



C



1



5



8



A



D



2



6



B



E



3

FIN

F

END

FIN

FACTORY DEFAULT



Barcode Settings

Code 11





Program

ALL

Family Code	PP	Parameter Selection	Option Code
 Code 11 Readability	SS	Disable ◀	0
	SS	Enable	1
 Code 11 Check Digit Verify	SS	Disable ◀	2
	SS	Verify with 1 modulo-11 check digit	3
	SS	Verify with 2 modulo-11 check digits	4
 Code 11 Check Digit Transmit	SS	Disable ◀	5
	SS	Transmit check digit	6

OPTION CODE



0



4



7



9



C



1



5



8



A



D



2



6



B



E



3

FIN

F

END

FIN

FACTORY DEFAULT



Barcode Settings

Code 11

ALL





Program

Family Code	PP	Parameter Selection	Option Code
 <p>Code 11 Minimum Length</p>	SS MS	Default (04) ◀ 01-Maximum After scanning the 2-digit code, the selection ends automatically.	FIN (2 digits)
 <p>Code 11 Maximum Length</p>	SS MS	Default (98) ◀ 98-Minimum After scanning the 2-digit code, the selection ends automatically..	FIN (2 digits)

For Code 11 Minimum Length and Maximum Length, the data length excludes start/stop characters, such as the barcode ID.

OPTION CODE



0



4



7



9



C



1



5



8



A



D



2



6



B



E



3

FIN

F

END

FIN

FACTORY DEFAULT



Barcode Settings

MSI





Program

ALL

Family Code	PP	Parameter Selection	Option Code
 MSI Readability	SS SS	Disable ◀ Enable	0 1
 MSI Check Digit Select	SS SS SS	Verify with MOD 10 check digit ◀ Verify with MOD 10-10 check digit Verify with MOD 11-10 check digit	2 3 4
 MSI Check Digit Transmit	SS SS	Disable ◀ Transmit check digit	5 6

OPTION CODE



0



4



7



9



C



1



5



8



A



D



2



6



B



E

3

FIN

F

END

FACTORY DEFAULT



Barcode Settings

MSI



Program

ALL

Family Code	PP	Parameter Selection	Option Code
 MSI Minimum Length	SS MS	Default (04) ◀ 01-Maximum <i>After scanning the 2-digit code, the selection ends automatically.</i>	FIN (2 digits)
 MSI Maximum Length	SS MS	Default (98) ◀ 98-Minimum <i>After scanning the 2-digit code, the selection ends automatically.</i>	FIN (2 digits)

For **MSI Minimum Length** and **Maximum Length**, the data length excludes start/stop characters, such as the barcode ID.

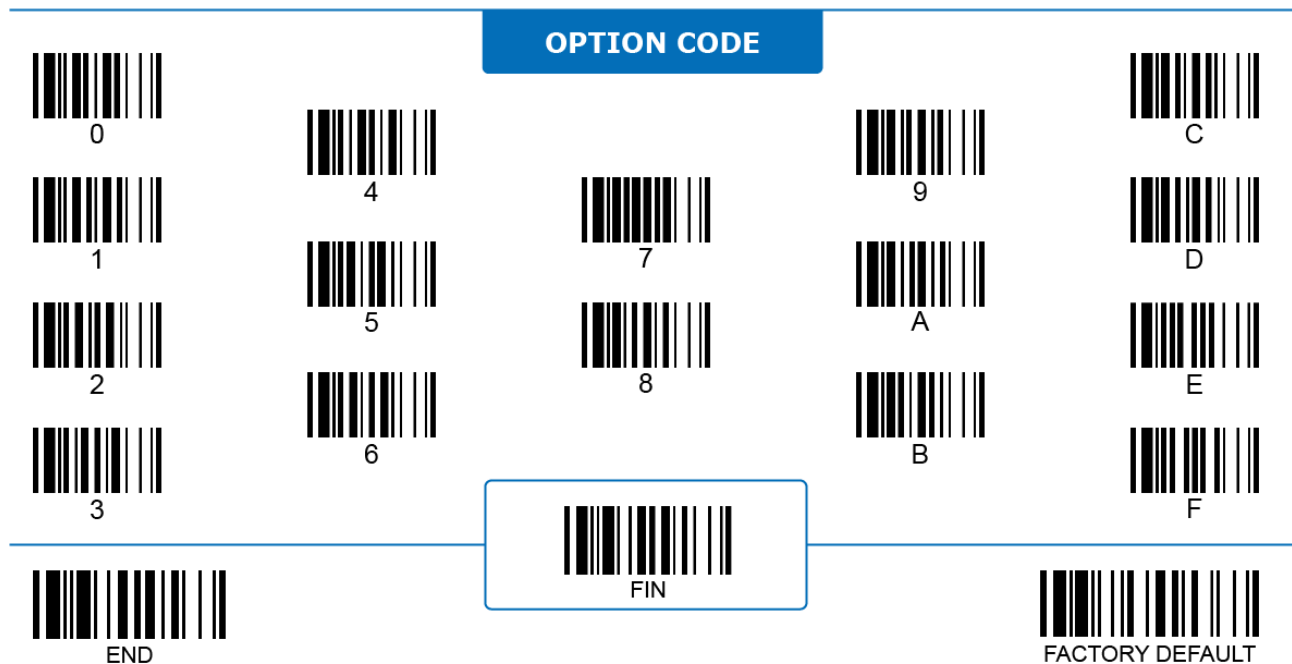

Barcode Settings

UK/Plessey

ALL





Program

Family Code	PP	Parameter Selection	Option Code
 UK/Plessey Readability	SS SS	Disable ◀ Enable	0 1
 UK/Plessey Primary Format	SS SS	Standard format ◀ CLSI format	2 3
 UK/Plessey X to A-F Convert	SS SS	Disable ◀ Convert X to A-F	4 5
 UK/Plessey Check Digit Transmit	SS SS	Disable ◀ Transmit check digit	6 7

OPTION CODE



0



1



2



3



4



5



6



7



8



9



A



B



C



D

E

F

END

FIN

FACTORY DEFAULT



Barcode Settings

UK/Plessey

ALL





Program

Family Code	PP	Parameter Selection	Option Code
 <p>UK/Plessey Minimum Length</p>	SS MS	Default (04) ◀ 01-Maximum After scanning the 2-digit code, the selection ends automatically.	FIN (2 digits)
 <p>UK/Plessey Maximum Length</p>	SS MS	Default (98) ◀ 98-Minimum After scanning the 2-digit code, the selection ends automatically.	FIN (2 digits)

For UK/Plessey Minimum Length and Maximum Length, the data length excludes start/stop characters, such as the barcode ID.

OPTION CODE



0



4



7



9



C



1



5



8



A



D



2



6



B



E

3

FIN

F

END

FACTORY DEFAULT



Barcode Settings

Telepen

ALL





Program

Family Code	PP	Parameter Selection	Option Code
 Telepen Readability	SS	Disable Telepen ◀	0
	SS	Enable Telepen	1
 Telepen Primary Format	SS	Telepen Numeric mode	2
	SS	Telepen Full ASCII mode ◀	3
 Telepen Check Digit Transmit	SS	Disable ◀	4
	SS	Transmit check digit	5

OPTION CODE



0



4



7



9



C



1



5



8



A



D



2



6



B



E

3

FIN

F

END

FACTORY DEFAULT

Barcode Settings

Telepen

ALL



Program

Family Code	PP	Parameter Selection	Option Code
<p>Telepen Minimum Length</p>	SS MS	Default (04) ◀ 01-Maximum <i>After scanning the 2-digit option code, selection will end automatically.</i>	FIN (2 digits)
<p>Telepen Maximum Length</p>	SS MS	Default (98) ◀ 98-Minimum <i>After scanning the 2-digit option code, selection will end automatically.</i>	FIN (2 digits)

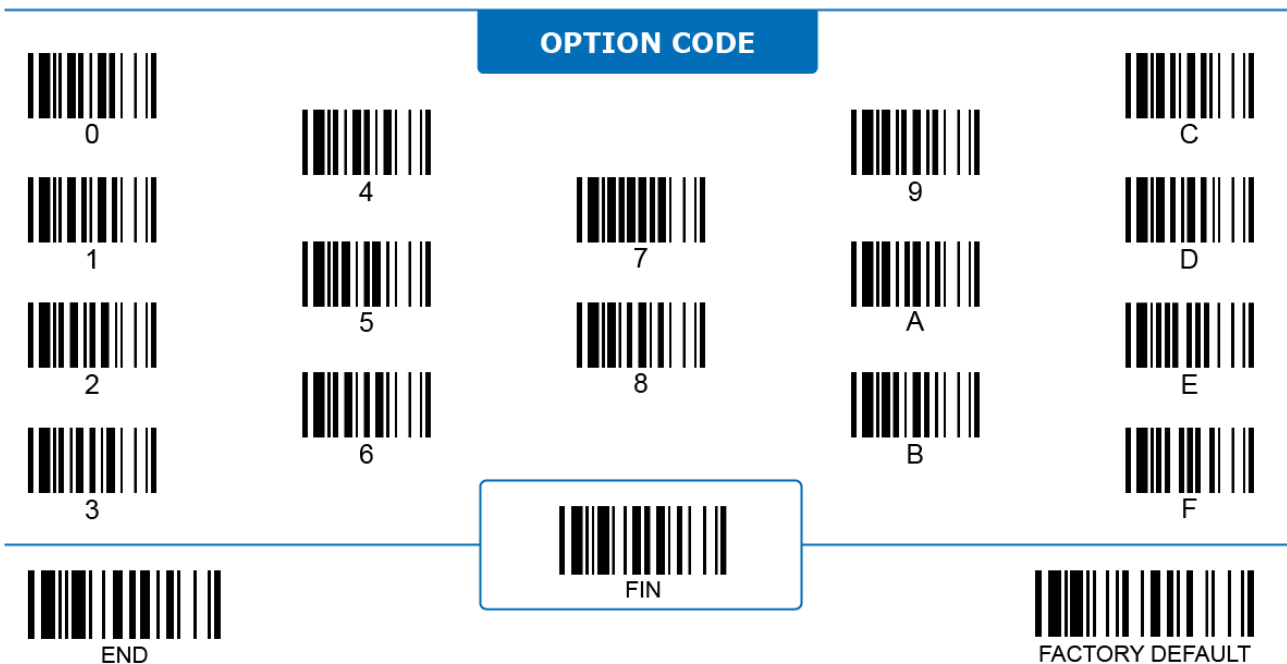

For **Telepen Minimum Length** and **Maximum Length**, the data length excludes start/stop characters, such as barcode ID.



Barcode Settings
Composite Code





















ALL

Family Code	PP	Parameter Selection	Option Code
 Composite Code Readability	SS	Disable ◀	0
	SS	Enable	1
 Composite Code UPC Link	SS	Disable ◀	2
	SS	Enable	3

Composite Code UPC Link: When disabled, the scanner transmits UPC regardless of the existence of the additional MicroPDF code. When enabled, the scanner only transmits those UPC codes extended with a MicroPDF code.

OPTION CODE

 0	 4	 7	 9	 C
 1	 5	 8	 A	 D
 2	 6	 B	 E	 F
 3	<div style="border: 1px solid blue; padding: 5px; display: inline-block;">  FIN </div>			
 END			 FACTORY DEFAULT	



Barcode Settings

PDF417, MicroPDF417





Program

ALL

Family Code	PP	Parameter Selection	Option Code
 PDF417 Readability	SS	Disable	0
	SS	Enable ◀	1
 MicroPDF417 Readability	SS	Disable ◀	2
	SS	Enable	3
	SS		
	SS		

OPTION CODE



0



4



7



9



C



1



5



A



D



2



6



8



B



E

3

FIN

F

END

FACTORY DEFAULT



Barcode Settings

QR Code

2D ONLY





Program

Family Code	PP	Parameter Selection	Option Code
 QR Code Readability	SS	Disable	0
	SS	Enable ◀	1
 Micro QR Readability	SS	Disable	2
	SS	Enable ◀	3

OPTION CODE



0



4



7



9



C



1



5



8



A



D



2



6



B



E

3

FIN

F

END

FACTORY DEFAULT



Barcode Settings

QR Code

2D ONLY





Program

Family Code	PP	Parameter Selection	Option Code
 QR Append	SS SS	Disable Enable ◀	4 5
 QR Inverse Reading	SS SS SS	Disable Enable Auto detect ◀	6 7 8
 QR Mirror Images	SS SS SS	Disable Enable Auto detect ◀	9 A B

- QR Code Append:** When enabled, the scanner only decodes and transmits data out once it collects all the QR codes splitted from a single data message by Structured Append mode.
- QR Code Inverse Reading:**
 - Disable:** When selected, the scanner ONLY decodes QR codes printed in a dark color over a light background.
 - Enable:** When selected, the scanner ONLY decodes QR codes printed in a light color over a dark background.
 - Auto detect:** When selected, the scanner decodes both normal and inversed QR codes.
- QR Code Mirror Images:**
 - Disable:** When selected, the scanner ONLY decodes standard QR codes.
 - Enable:** When selected, the scanner ONLY decodes mirrored (flipped) QR codes.
 - Auto detect:** When selected, the scanner decodes both standard and mirrored QR codes.

OPTION CODE



0



4



7



9



C



1



5



8



A



D



2



6



B



E



3

FIN

F

END

FIN

FACTORY DEFAULT



Barcode Settings

QR Code

2D ONLY



Program

Family Code	PP	Parameter Selection	Option Code
 QR Minimum Length	SS MS	Default (01) ◀ 01-Maximum <i>After scanning the 2-digit code, the selection ends automatically.</i>	FIN (4 digits)
 QR Maximum Length	SS MS	Default (7089) ◀ 7089-Minimum <i>After scanning the 2-digit code, the selection ends automatically.</i>	FIN (4 digits)

For QR Code Minimum Length and Maximum Length, the data length excludes start/stop characters, such as the barcode ID.

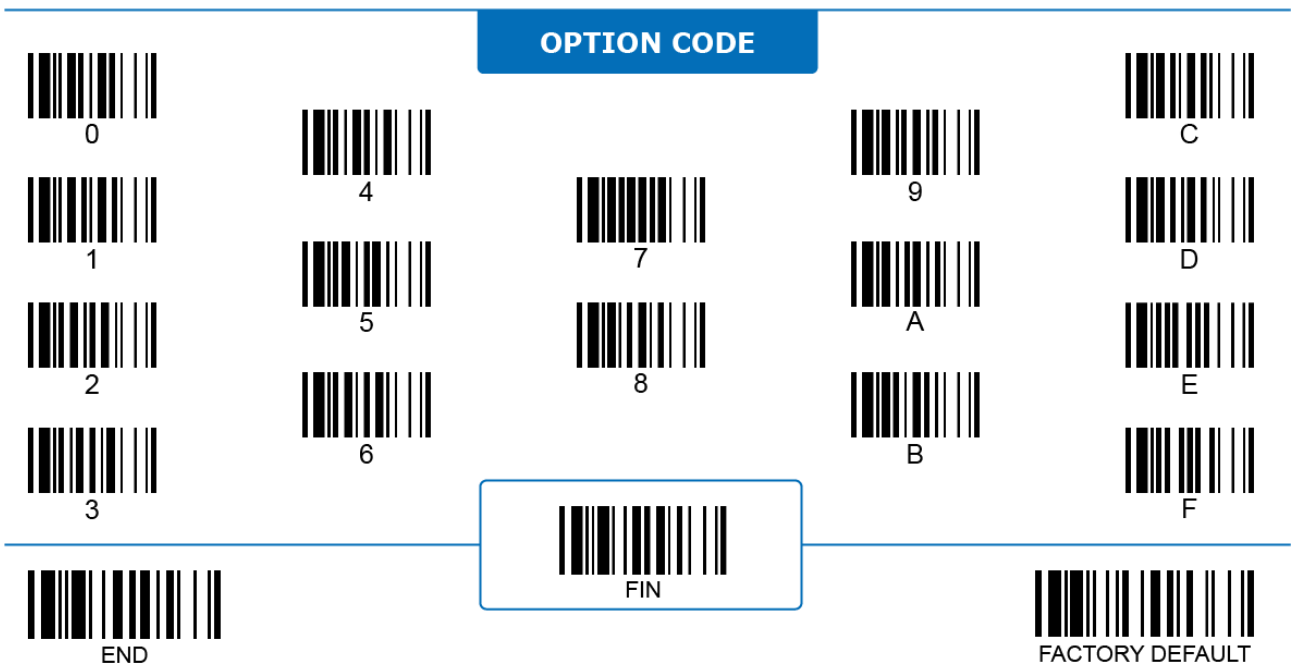



Barcode Settings

Data Matrix

2D ONLY





















Program

Family Code	PP	Parameter Selection	Option Code
 Data Matrix Readability	SS	Disable	0
	SS	Enable ◀	1
 DM Inverse Reading	SS	Disable	4
	SS	Enable	5
	SS	Auto detect ◀	6
 DM Mirror Images	SS	Disable	7
	SS	Enable	8
	SS	Auto detect ◀	9

1. **Data Matrix Inverse Reading:**
 - i. **Disable:** When selected, the scanner ONLY decodes Data Matrix codes printed in a dark color over a light background.
 - ii. **Enable:** When selected, the scanner ONLY decodes Data Matrix codes printed in a light color over a dark background.
 - iii. **Auto detect:** When selected, the scanner decodes both normal and inversed Data Matrix codes.
2. **Data Matrix Mirror Images:**
 - i. **Disable:** When selected, the scanner ONLY decodes standard Data Matrix codes.
 - ii. **Enable:** When selected, the scanner ONLY decodes mirrored (flipped) Data Matrix codes.
 - iii. **Auto detect:** When selected, the scanner decodes both standard and mirrored Data Matrix codes.

OPTION CODE

 0	 4	 7	 9	 C
 1	 5	 8	 A	 D
 2	 6	 B	 E	 F
 3	<div style="border: 1px solid blue; padding: 10px; display: inline-block;">  FIN </div>			 END
				 FACTORY DEFAULT

Barcode Settings

Data Matrix

2D ONLY



Program

Family Code	PP	Parameter Selection	Option Code
<p>DM Minimum Length</p>	SS MS	Default (01) ◀ 01-Maximum <i>After scanning the 2-digit code, the selection ends automatically.</i>	FIN (4 digits)
<p>DM Maximum Length</p>	SS MS	Default (3116) ◀ 3116-Minimum <i>After scanning the 2-digit code, the selection ends automatically.</i>	FIN (4 digits)
<p>DM Poor Quality Reading</p>	SS SS	Disable ◀ Enable	0 1

- For **Data Matrix Minimum Length** and **Data Matrix Maximum Length**, the data length excludes start/stop characters, such as the barcode ID.
- Data Matrix Poor Quality Reading** configures how well the scanner decodes a high density or poor quality Data Matrix code. Set the level higher if you have difficulty reading challenging Data Matrix codes. Be aware that when this function is enabled, the snappiness of the scanner will be compromised.

OPTION CODE

0

4

7

9

C

1

5

8

A

D

2

6

B

E

3

FIN

F

END

FIN

FACTORY DEFAULT



Barcode Settings

MaxiCode

2D ONLY





Program

Family Code	PP	Parameter Selection	Option Code
 MaxiCode Readability	SS SS	Disable ◀ Enable	0 1
 MaxiCode Minimum Length	SS MS	Default (01) ◀ 01-Maximum After scanning the 2-digit code, the selection ends automatically.	FIN (3 digits)
 MaxiCode Maximum Length	SS MS	Default (150) ◀ 150-Minimum After scanning the 2-digit code, the selection ends automatically.	FIN (3 digits)

For **MaxiCode Minimum Length** and **Maximum Length**, the data length excludes start/stop characters, such as the barcode ID.

OPTION CODE



0



4



7



9



C



1



5



8



A



D



2



6



B



E



3

FIN

F

END

FIN

FACTORY DEFAULT



Barcode Settings

Aztec Code

2D ONLY





Program

Family Code	PP	Parameter Selection	Option Code
 Aztec Code Readability	SS	Disable	0
	SS	Enable ◀	1
 Aztec Append	SS	Disable	2
	SS	Enable ◀	3
 Aztec Inverse Reading	SS	Disable	4
	SS	Enable	5
	SS	Auto detect ◀	6

1. **Aztec Code Append:** When enabled, the scanner only decodes and transmits data out once it collects all the Aztec codes splitted from a single data message by Structured Append mode.
2. **Aztec Code Inverse Reading:**
 - i. **Disable:** When selected, the scanner ONLY decodes Aztec codes printed in a dark color over a light background.
 - ii. **Enable:** When selected, the scanner ONLY decodes Aztec codes printed in a light color over a dark background.
 - iii. **Auto detect:** When selected, the scanner decodes both normal and inversed Aztec codes.

OPTION CODE



0



4



7



9



C



1



5



8



A



D



2



6



B



E



3

FIN

F

END

FIN

FACTORY DEFAULT



Barcode Settings

Aztec Code

2D ONLY





Program

Family Code	PP	Parameter Selection	Option Code
 Aztec Minimum Length	SS MS	Default (01) ◀ 01-Maximum <i>After scanning the 2-digit code, the selection ends automatically.</i>	FIN (4 digits)
 Aztec Maximum Length	SS MS	Default (3832) ◀ 3832-Minimum <i>After scanning the 2-digit code, the selection ends automatically.</i>	FIN (4 digits)

For Aztec Code Minimum Length and Maximum Length, the data length excludes start/stop characters, such as the barcode ID.

OPTION CODE



0



4



7



9



C



1



5



8



A



D



2



6



B



E



3

FIN

F

END

FIN



FACTORY DEFAULT

Postal Code Settings
Australia Post Code



Program

ALL

Family Code	PP	Parameter Selection	Option Code
 Australia Post Readability	SS	Disable ◀	0
	SS	Enable	1
 Australia Post Encode	SS	Transmit with raw format ◀	2
	SS	Transmit with numeric encoding (N Table)	3
	SS	Transmit with alphanumeric encoding (C Table)	4
	SS	Auto-discriminate encoding (Combine C & N Table)	5

Australia Post Encode configures which encoding table the scanner refers to when decoding Australia Post Codes.

- i. **Auto-discriminate encoding** increases chance of misread because the encoded data format does not specify the encoding table it is based on.

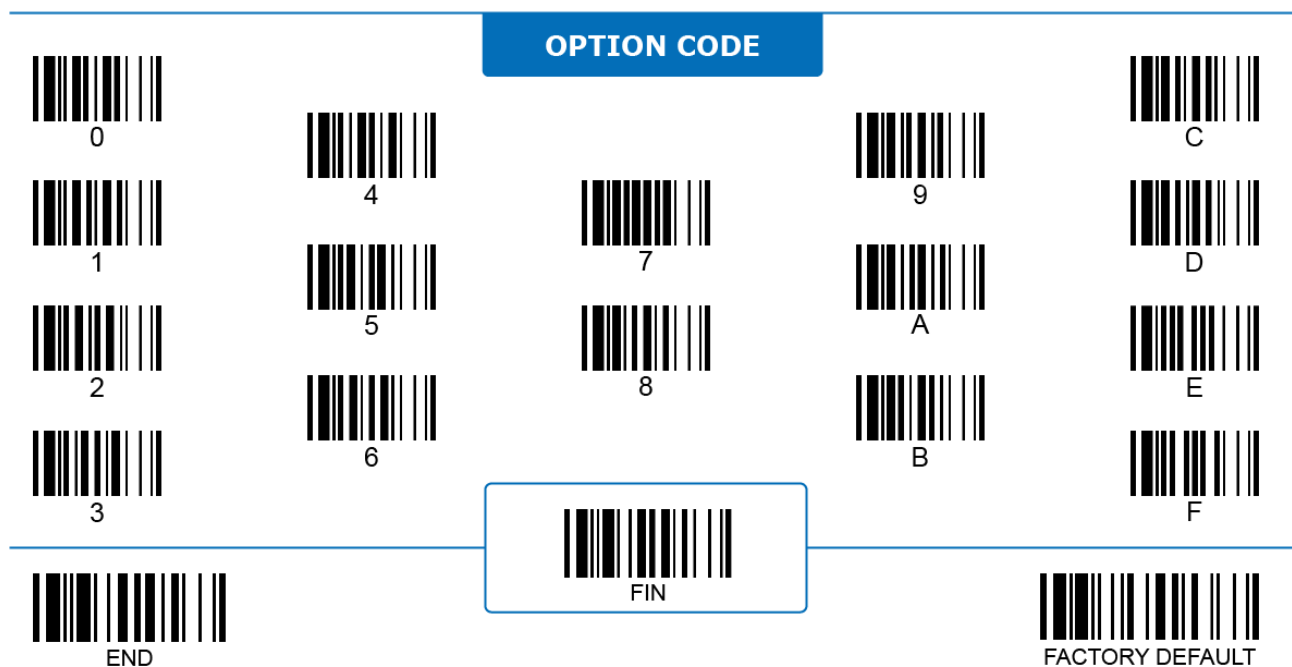



Postal Code Settings
British Post Code





Program

ALL

Family Code	PP	Parameter Selection	Option Code
 British Post Readability	SS	Disable ◀	0
	SS	Enable	1
 British Post Check Digit Transmit	SS	Disable ◀	2
	SS	Transmit check digit	3

OPTION CODE



0



4



7



9



C



1



5



8



A



D



2



6



B



E

3

FIN

F

END

FACTORY DEFAULT



Postal Code Settings

Netherlands KIX Code, Posi LAPA Code





Program

ALL

Family Code	PP	Parameter Selection	Option Code
 Netherlands KIX Code Readability	SS	Disable ◀	0
	SS	Enable	1
 Posi LAPA Code Readability	SS	Disable ◀	0
	SS	Enable	1

OPTION CODE



0



4



7



9



C



1



5



8



A



D



2



6



B



E

3

FIN

F

END

FACTORY DEFAULT

Postal Code Settings

Japan Post, Korea Post Code



Program

ALL

Family Code	PP	Parameter Selection	Option Code
<p>Japan Post Readability</p>	SS SS	Disable ◀ Enable	0 1
<p>Korea Post Readability</p>	SS SS	Disable ◀ Enable Length fixed at 6 characters.	0 1

OPTION CODE

0

4

7

9

C

1

5

8

A

D

2

6

B

E

3

FIN

F

END

FIN

FACTORY DEFAULT

Postal Code Settings
US Planet



Program

ALL

Family Code	PP	Parameter Selection	Option Code
<p>US Planet Readability</p>	SS	Disable ◀	0
	SS	Enable	1
<p>US Planet Check Digit Transmit</p>	SS	Disable ◀	2
	SS	Transmit check digit	3

OPTION CODE

0

4

7

9

C

1

5

8

A

D

2

6

B

E

3

FIN

F

END

FIN

FACTORY DEFAULT



Postal Code Settings

US POSTNET



Program

ALL

Family Code	PP	Parameter Selection	Option Code
 US POSTNET Readability	SS	Disable ◀	0
	SS	Enable	1
 US POSTNET Check Digit Transmit	SS	Disable ◀	2
	SS	Transmit check digit	3

OPTION CODE



0



4



7



9



C



1



5



A



D



2



6



8



B



E



3



FIN



F



END



FACTORY DEFAULT

Postal Code Settings
Intelligent Mail



Program

ALL

Family Code	PP	Parameter Selection	Option Code
 Intelligent Mail Readability	SS	Disable ◀	0
	SS	Enable	1

Intelligent Mail Readability: When enabled, the scanner decodes Intelligent Mail (USPS4CB/One Code) and transmits data.

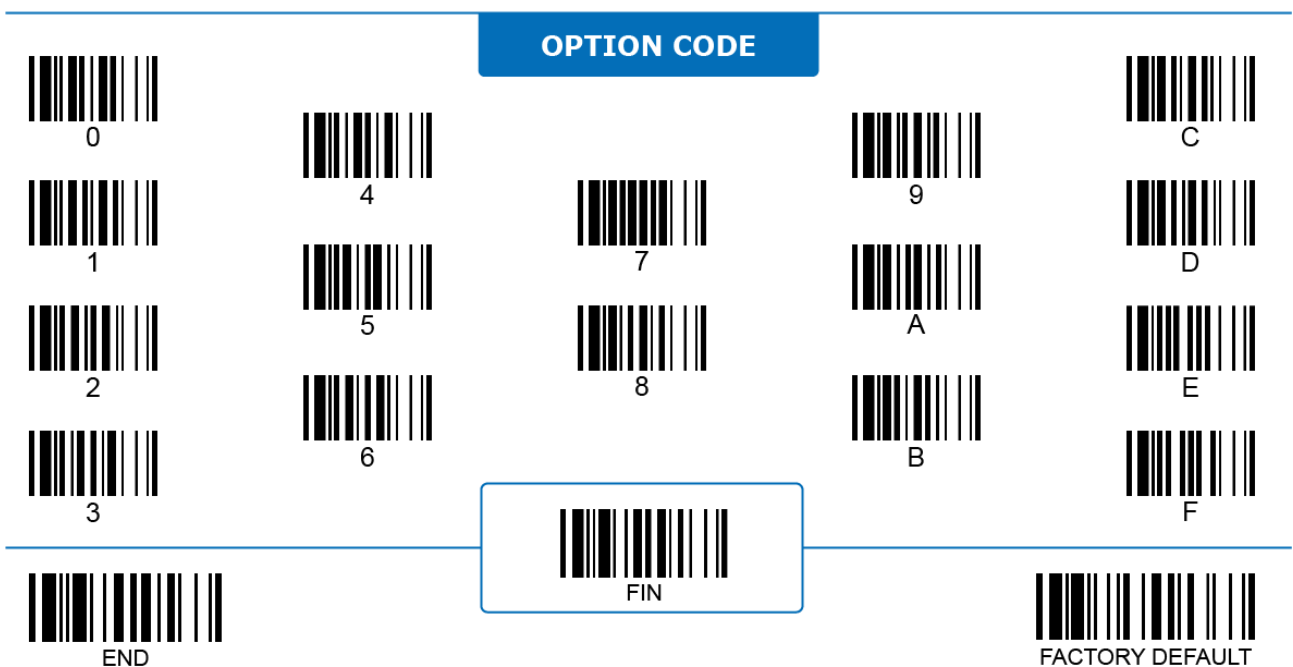

GS1 Settings

GS1 128

ALL



Program

Family Code	PP	Parameter Selection	Option Code
<p>GS1 128 Readability</p>	SS SS	Disable Enable ◀	0 1
<p>GS1 128 Min. Length</p>	SS MS	Default (01) ◀ 01-Maximum <i>After scanning the 2-digit code, the selection ends automatically.</i>	FIN (2 digits)
<p>GS1 128 Max. Length</p>	SS MS	Default (98) ◀ 98-Minimum <i>After scanning the 2-digit code, the selection ends automatically.</i>	FIN (2 digits)

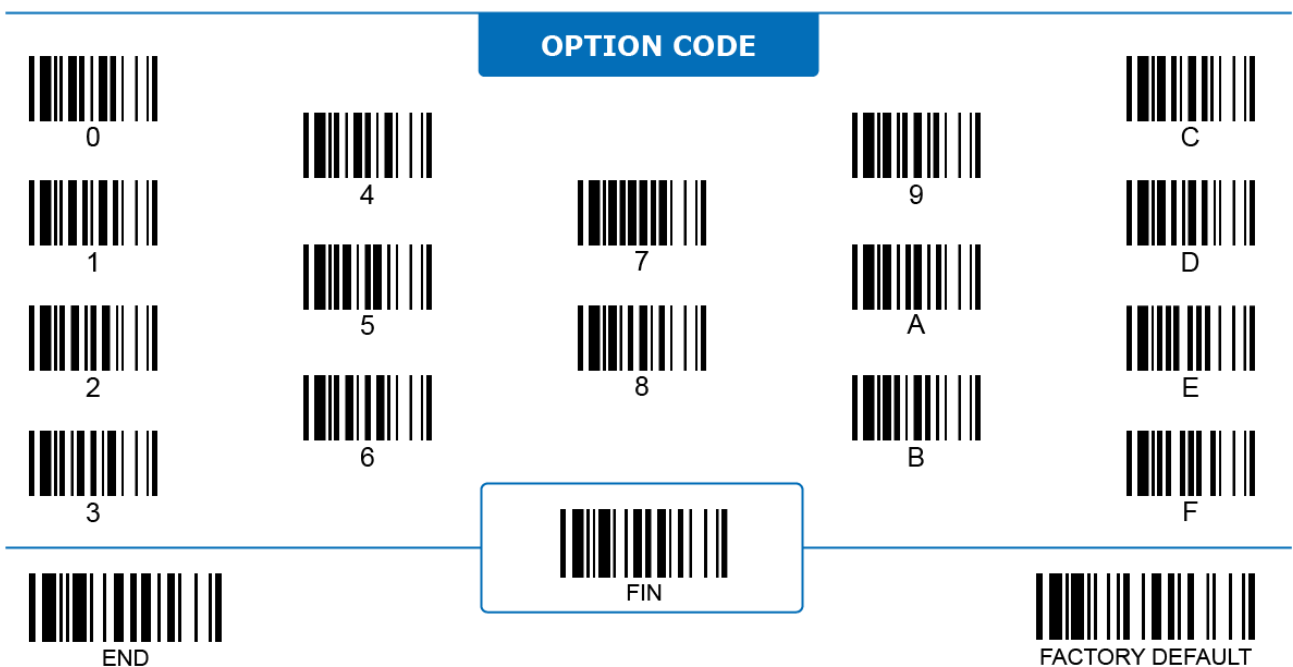

For GS1 128 Minimum Length and Maximum Length, the data length excludes start/stop characters, such as the barcode ID.



GS1 Settings
GS1 DataBar





ALL

Family Code	PP	Parameter Selection	Option Code
 GS1 DataBar	SS SS	Disable GS1 DataBar Enable GS1 DataBar ◀	0 1
 GS1 DataBar Ltd.	SS SS	Disable GS1 DataBar Limited Enable GS1 DataBar Limited ◀	2 3
 GS1 DataBar Exp.	SS SS	Disable GS1 DataBar Expanded Enable GS1 DataBar Expanded ◀	4 5

OPTION CODE



0



4



7



9



C



1



5



8



A



D



2



6



B



E

3

FIN

F

END



FACTORY DEFAULT

GS1 Settings
GS1 DataBar





















Program

ALL

Family Code	PP	Parameter Selection	Option Code
 GS1 DataBar Expanded Minimum Length	SS MS	Default (04) ◀ 01-Maximum <i>After scanning the 2-digit code, the selection ends automatically.</i>	FIN (2 digits)
 GS1 DataBar Expanded Maximum Length	SS MS	Default (74) ◀ 74-Minimum <i>After scanning the 2-digit code, the selection ends automatically.</i>	FIN (2 digits)

For GS1 DataBar Expanded Minimum Length and Maximum Length, the data length excludes start/stop characters, such as the barcode ID.

OPTION CODE

 0	 4	 7	 9	 C
 1	 5	 8	 A	 D
 2	 6	 B	 E	 F
 3	 FIN			
 END			 FACTORY DEFAULT	

4 OPERATION MODES

This chapter provides a complete list of available operation modes for each of the product series. To fulfill the needs in different application scenarios, the available mode options and default mode of scanners vary from series to series.

Operation Modes

Corded Handheld Imagers





















Program

Family Code	PP	Parameter Selection	Option Code
 Operation Mode	SS	Trigger mode ◀	1
	SS	Presentation mode	2
	SS	Force mode	9
	SS	Multiple read mode	C

- Trigger Mode:** The scanner goes into standby after each scan. Press the trigger to scan again.
- Presentation Mode:** The scanner begins scanning automatically when it detects an object entering its scan area. For 2D scanners, see “**2D Image Sensitivity**” for sensitivity level adjustment.
- Force Mode:** The scanner always keeps its LED illumination on and scans automatically for continuous operation.
- Multiple Read Mode:** Press and hold the trigger to decode multiple barcodes. The scanner beeps for each good read. Enable **Center Alignment, Handheld** for more precise reading, or **Unique Barcode Reporting Control** to avoid reading the same code multiple times.

OPTION CODE

 0	 4	 7	 9	 C
 1	 5	 8	 A	 D
 2	 6	 B	 E	 F
 3	<div style="border: 1px solid black; padding: 10px; display: inline-block;">  FIN </div>		 END	 FACTORY DEFAULT

Operation Modes

Cordless Handheld Imagers



Program

Family Code	PP	Parameter Selection	Option Code
 Operation Mode	SS	Trigger mode ◀	1
	SS	Presentation mode	2
	SS	Multiple Read mode	C

1. **Trigger Mode:** The scanner goes into standby after each scan. Press the trigger to scan again.
2. **Presentation Mode:** The scanner begins scanning automatically when it detects an object entering its scan area. For 2D scanners, see “2D Image Sensitivity” for sensitivity level adjustment.
3. **Multiple Read Mode:** Press and hold the trigger to decode multiple barcodes. The scanner beeps for each good read. Enable **Center Alignment, Handheld** for more precise reading, or **Unique Barcode Reporting Control** to avoid reading the same code multiple times.

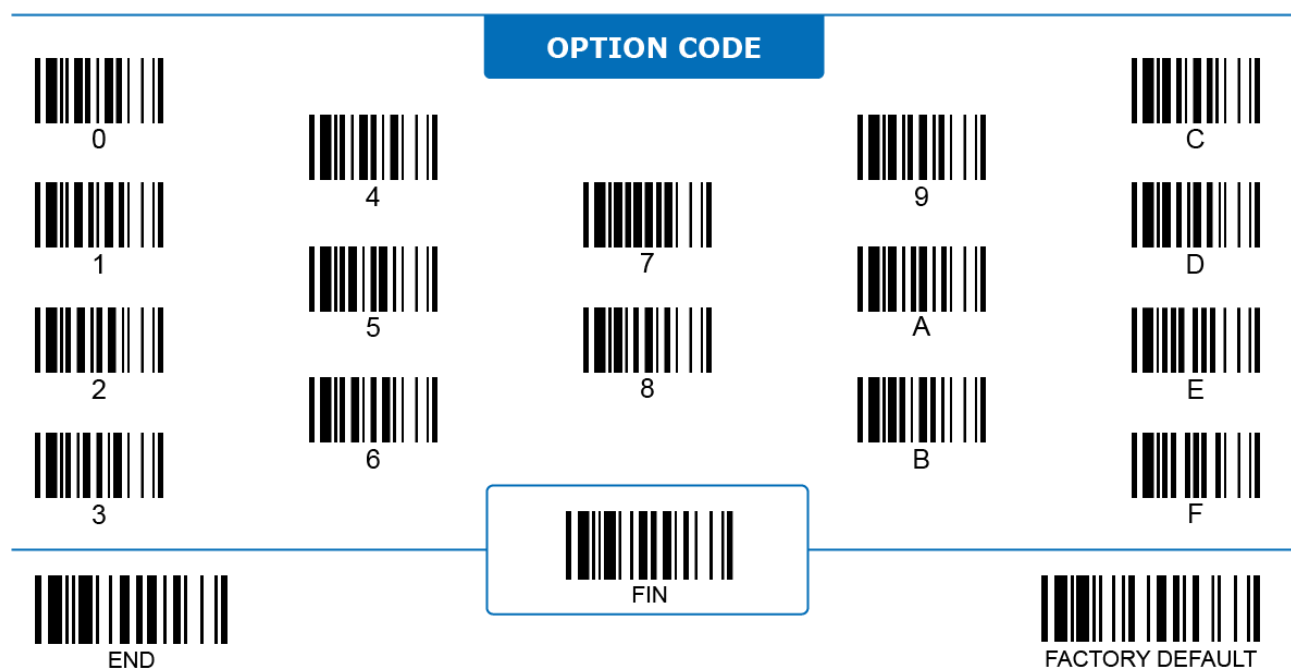

Operation Modes

Companion Scanners



Program

Family Code	PP	Parameter Selection	Option Code
 Operation Mode	SS	Trigger mode ◀	1
	SS	Multiple Read mode	C

- Trigger Mode:** After each scan, the scanner goes into low power standby after the **Time Delay to Low Power State** is up. Press the trigger to activate scanner and begin another scan session.
- Multiple Read Mode:** Press and hold the trigger to decode multiple barcodes. The scanner beeps for each good read. Enable **Center Alignment, Handheld** for more precise reading, or **Unique Barcode Reporting Control** to avoid reading the same code multiple times.

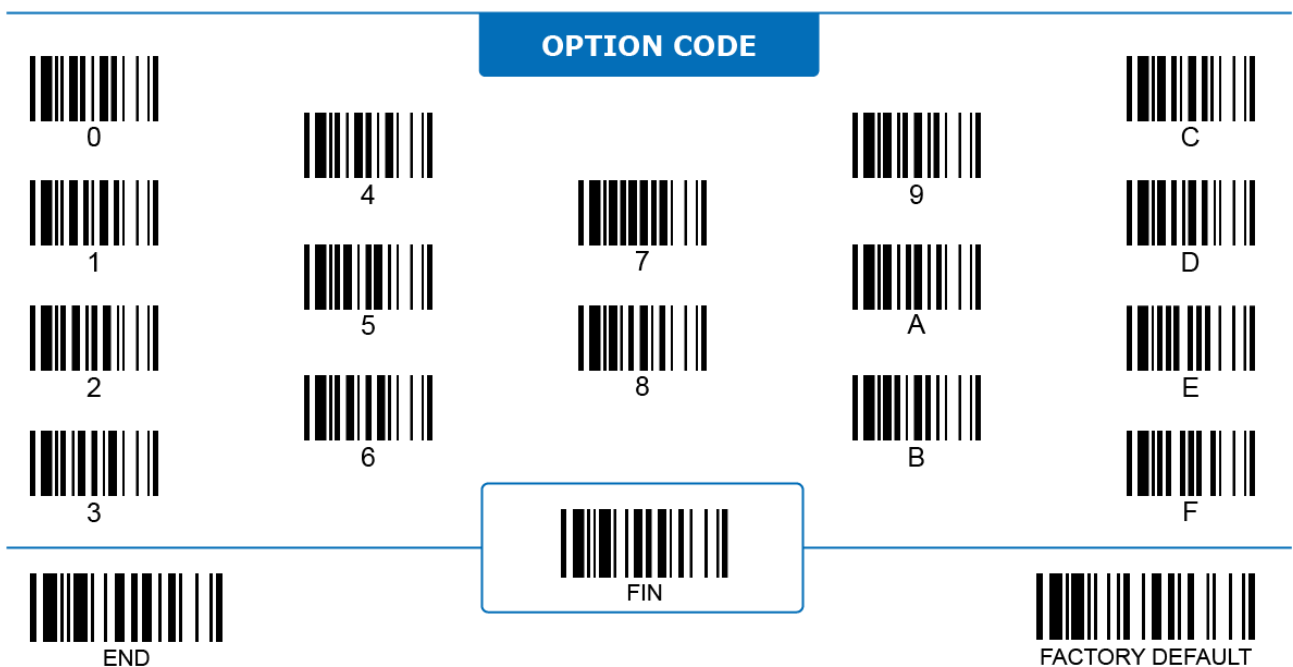

Operation Modes

Fixed Mount Scanners



Program

Family Code	PP	Parameter Selection	Option Code
 Operation Mode	SS	Trigger mode ◀	1
	SS	Presentation mode	2
	SS	Force mode	9

1. **Trigger Mode:** The scanner goes into standby after each scan. Press trigger to scan again.
2. **Presentation Mode:** The scanner begins to scan automatically when it detects an object entering its scan area. For 2D scanners, see “2D Image Sensitivity” for sensitivity level adjustment.
3. **Force Mode:** The scanner always keeps its LED illumination on and scans automatically for continuous operation.

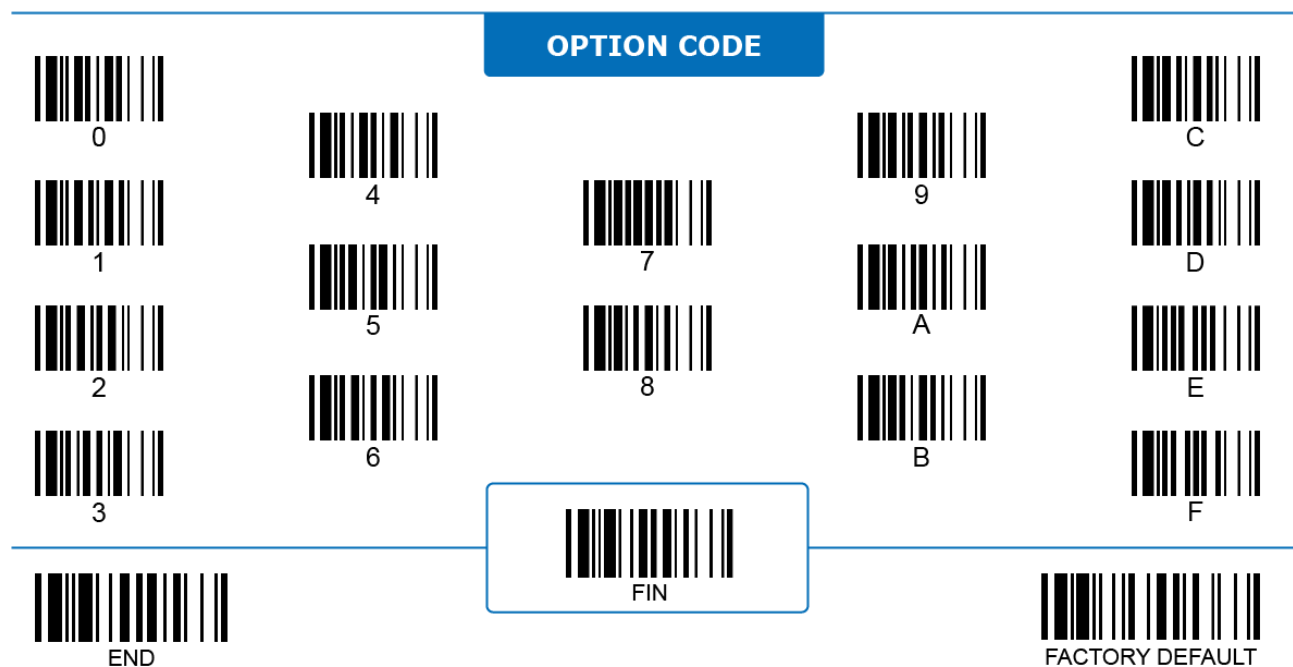

Operation Modes

On-counter Scanners





Program

Family Code	PP	Parameter Selection	Option Code
 Operation Mode	SS	Trigger mode	1
	SS	Presentation mode ◀	2
	SS	Force mode	9
	SS	Multiple Read mode	C

- Trigger Mode:** The scanner goes into standby after each scan. Press the trigger to scan again.
- Presentation Mode:** The scanner begins to scan automatically when it detects an object entering its scan area. For 2D scanners, see “2D Image Sensitivity” for sensitivity level adjustment.
- Force Mode:** The scanner always keeps its LED illumination on and scans automatically for continuous operation.
- Multiple Read Mode:** Press and hold the trigger to decode multiple barcodes. The scanner beeps for each good read. Enable **Center Alignment** for more precise reading, or enable **Unique Barcode Reporting Control** to avoid reading the same code multiple times.

OPTION CODE



0



4



7



9



C



1



5



8



A



D



2



6



B



E

3

FIN

F

END

FACTORY DEFAULT

5 OPERATION CONTROL

This chapter presents the parameters related to the operation of your scanner. In it, you will find settings for functionalities, including general scanner settings, user feedback control (such as the buzzer and vibration function), and special parameters for different scanners.

Scanner Operation

Reread Delay, Good Read Delay



Program

Family Code	PP	Parameter Selection	Option Code
<p>Reread Delay</p>	SS	Disable	0
	SS	Immediate	1
	SS	Extremely short ◀	2
	SS	Short	3
	SS	Medium	4
	SS	Long	5
	SS	Force verification	6
	<p>Good Read Delay</p>	SS	None ◀
SS		200 ms	1
SS		500 ms	2
SS		1 sec	3
SS		1.5 sec	4
SS		2 sec	5
SS		3 sec	6

1. **Reread Delay** prevents the scanner from decoding the same barcode twice in a pre-defined duration. Among the options, **Force verification** prevents decoding the same barcode twice before the trigger session ends. Reread Delay is only effective under handsfree modes.
2. **Good Read Delay** configures the short duration before a scanner can read any barcode again after it successfully decodes a barcode and transmits it.

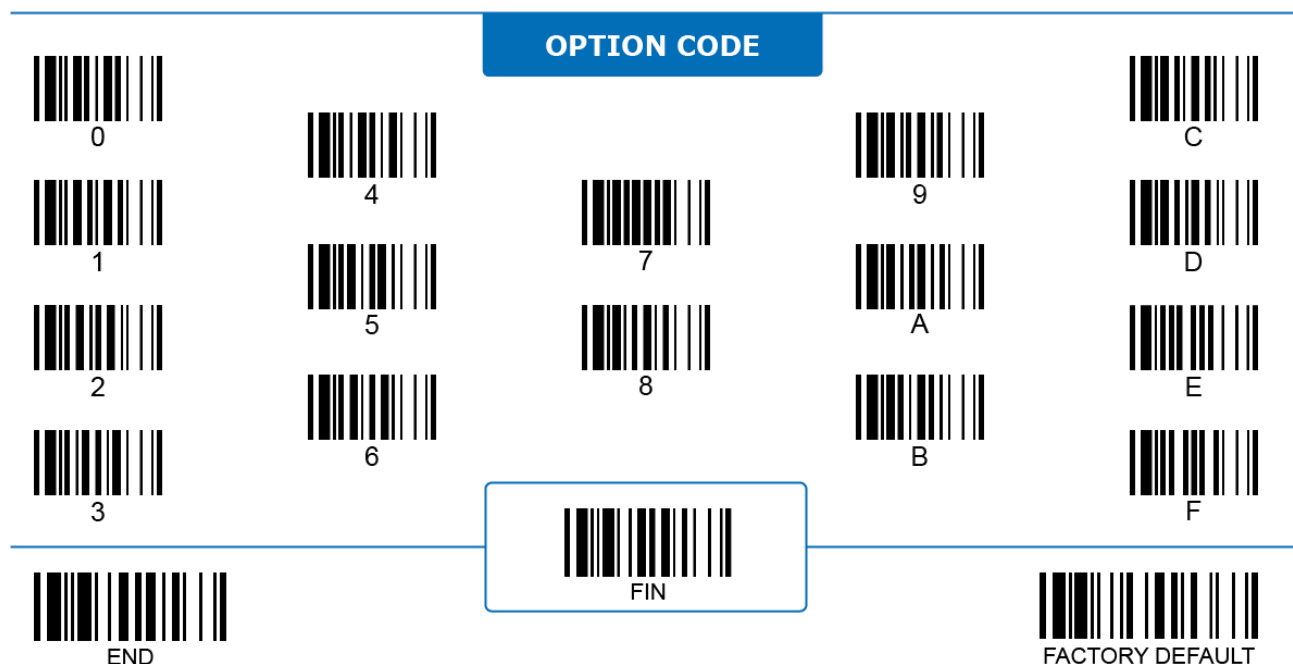

Handheld Decode Timeout



Program

ALL

Family Code	PP	Parameter Selection	Option Code
<p>Handheld Decode Timeout</p>	SS	Disable ◀	0
	SS	100 ms	1
	SS	200 ms	2
	SS	300 ms	3
	SS	400 ms	4
	SS	500 ms	5
	SS	600 ms	6
	SS	700 ms	7
	SS	800 ms	8
	SS	900 ms	9
	SS	1 sec	A
	SS	2 sec	B
	SS	4 sec	C
	SS	6 sec ◀ (Default for Cordless Bluetooth scanners)	D
	SS	8 sec	E
	MS	User-defined: 1 – 99 sec	F, (2 digits)

Handheld Decode Timeout configures the duration of a decode session under the **trigger mode** and under **multiple read mode**.

1. When **enabled**, the scanner ends a decode session when any of following event happens:
 - i. The scanner successfully decodes and transmits a barcode during the decode session. The result is categorized as a “Good Read” (or an “OK”).
 - ii. The scanner cannot decode any barcode before the time is up. The result is categorized as a “No Good Read” (or a “NG”).
 - iii. Trigger or button of the scanner is released before the scanner can decode a barcode.
 - iv. The scanner received a **Serial Trigger Off** command before it can decode a barcode.
2. When **disabled**, the scanner ends a decode session when any of the above events happen except event ii: cannot decode any barcode before the time is up.

OPTION CODE

0

4

7

9

C

1

5

8

A

D

2

6

B

E

3

FIN

F

END

FACTORY DEFAULT

Scanner Operation

Handsfree Decode Timeout



Program

ALL

Family Code	PP	Parameter Selection	Option Code
<p>Handsfree Decode Timeout</p>	SS	100 ms	1
	SS	200 ms	2
	SS	300 ms	3
	SS	400 ms	4
	SS	500 ms	5
	SS	600 ms	6
	SS	700 ms	7
	SS	800 ms	8
	SS	900 ms	9
	SS	1 sec	A
	SS	2 sec ◀ (Default for On-counter scanners)	B
	SS	4 sec	C
	SS	6 sec ◀	D
	SS	8 sec	E
	MS	User-defined: 1 – 99 sec	F, (2 digits)

Hands-free Decode Timeout configures the duration of a decode session under **presentation mode**. The scanner ends a decode session when any of following event happens:

- i. The scanner successfully decodes and transmits a barcode during the decode session. The result is categorized as a “Good Read” (or an “OK”).
- ii. The scanner cannot decode any barcode before the time is up. The result is categorized as a “No Good Read” (or a “NG”).

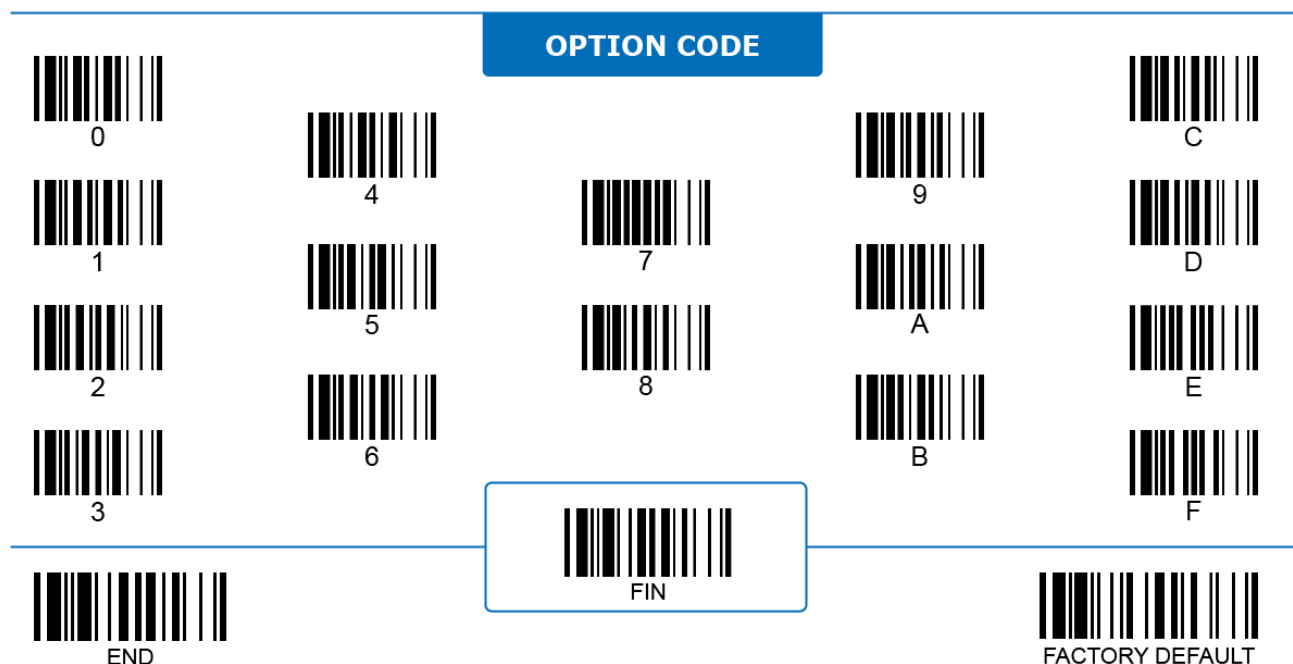

Scanner Operation

Presentation Trigger Select



Program

ON COUNTER

Family Code	PP	Parameter Selection	Option Code
 Presentation Trigger Select	SS	Image proximity sensing	0
	SS	IR proximity sensing ◀	1

Presentation Trigger Select configures which sensor the scanner relies on to trigger a decode session under presentation mode.

- i. **Image proximity sensing:** The scanner uses its image sensor to continuously monitor the environment when the scanner is in standby condition. It is triggered to scan if the image sensor detects something entering its field of view and approaching to the scanner.
- ii. **IR proximity sensing:** The scanner uses its IR sensor to continuously monitor the environment when the scanner is in standby condition. It is triggered to scan if the IR sensor detects something entering its field of view and approaching to the scanner.

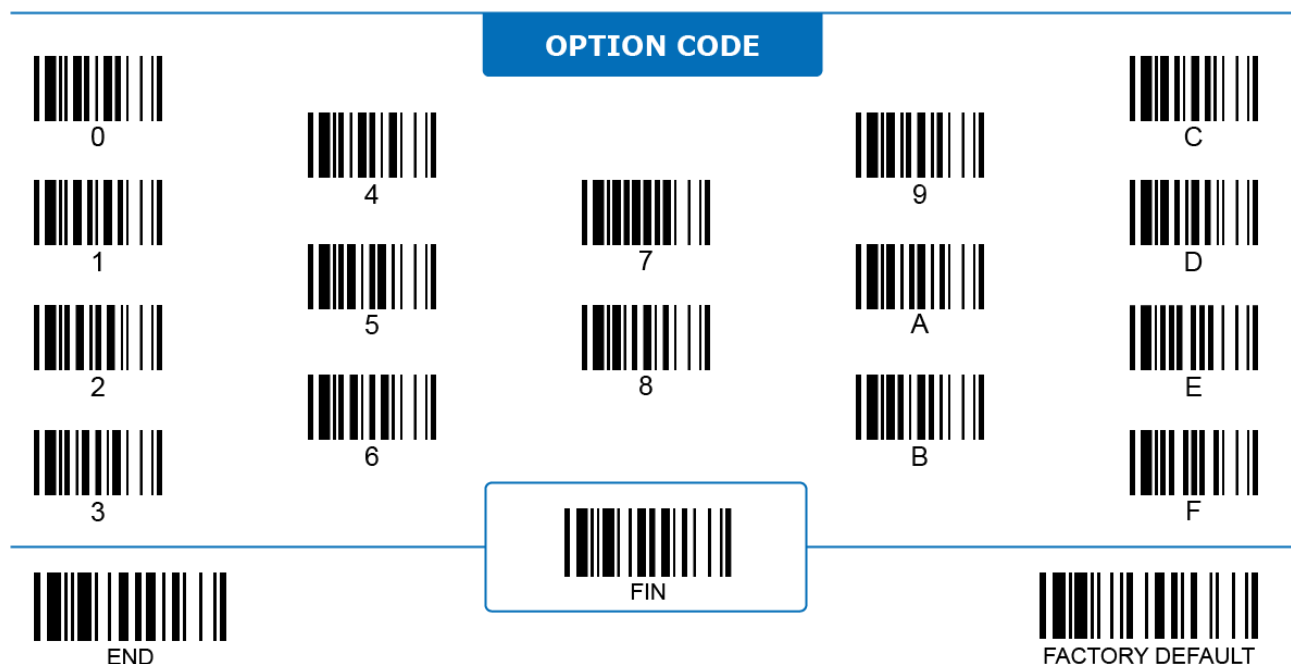

Scanner Operation

Presentation Continuous Scan



Program

ON COUNTER

Family Code	PP	Parameter Selection	Option Code
 Presentation Continuous Scan	SS	Disable	1
	SS	Enable ◀	0

Presentation Continuous Scan: When enabled, the scanner begins a new decode session immediately after it has a Good Read (decoded a barcode and transmitted it out successfully). Otherwise, the scanner goes into standby condition once it has a Good Read and waits for next triggering event.

Continuous scan improves the speed of the scanner under presentation mode.

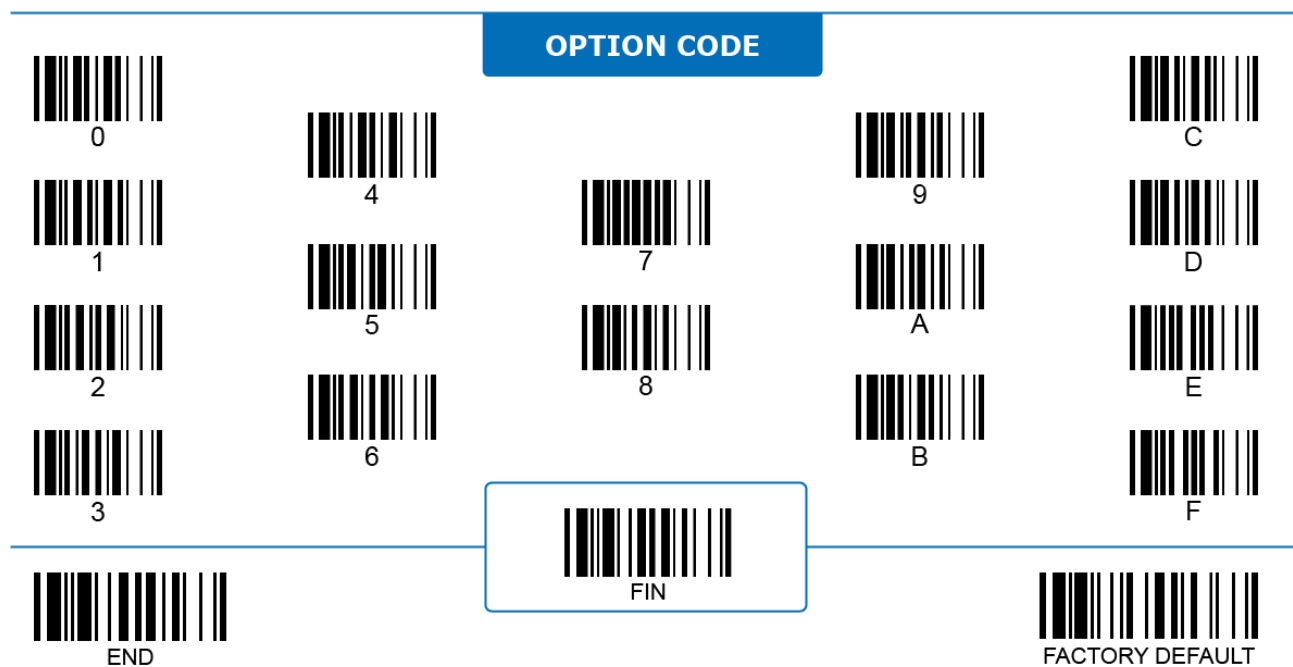



Scanner Operation

Object-in/Object-out Message Output



Program

ON COUNTER

Family Code	PP	Parameter Selection	Option Code
 Object-in Message Output	SS	None ◀	0
	SS	Default message "OBJECT_IN" with CRLF	1
	MS	User-defined message 1 to 15 characters; scan "FIN" to finish the setting. Available with IR proximity and Image proximity sensing	2, [00 - 7F]
 Object-out Message Output	SS	None ◀	0
	SS	Default message "OBJECT_OUT" with CRLF	1
	MS	User-defined message 1 to 15 characters; scan "FIN" to finish the setting. Available with IR proximity sensing.	2, [00 - 7F]

- Object-in Message Output:** When enabled, the scanner sends out an "OBJECT_IN" message to the host when its image or IR-based proximity sensor detects any object entering its reading range and begins a decode session. Available under presentation mode with either image or IR proximity sensing.
- Object-out Message Output:** When enabled, the scanner sends out an "OBJECT_OUT" message to the host when its IR-based proximity sensor finds that the detected object leaving its reading range and ends the decode session. Only available under presentation mode with IR proximity sensing.

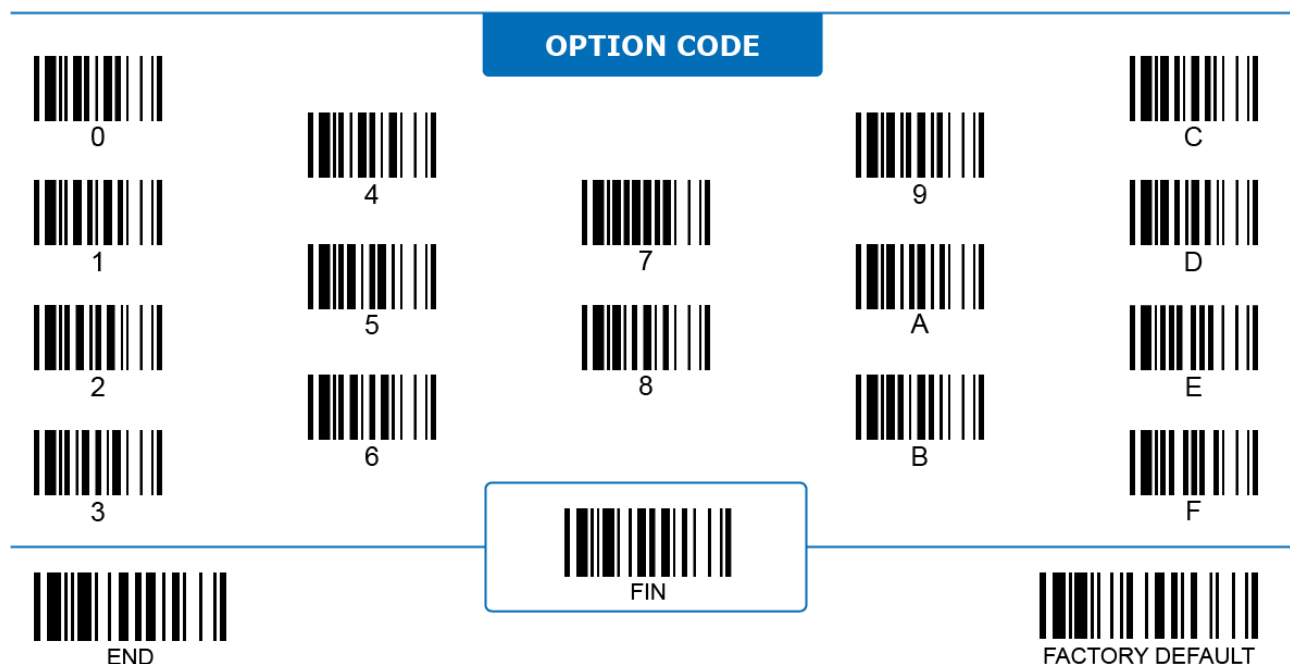

Scanner Operation

2D Image Sensitivity

2D ONLY



Program

Family Code	PP	Parameter Selection	Option Code
 2D Image Sensitivity	SS	Level 1	0
	SS	Level 2	1
	SS	Level 3	2
	SS	Level 4	3
	SS	Level 5 ◀	4
	SS	Level 6	5
	SS	Level 7	6

2D Image Sensitivity configures the sensitivity when the scanner uses its image sensor to trigger a decode session under presentation mode. The higher the level is, the more sensitive the image sensor is to catch a moving object and trigger a scan session. Setting the sensitivity level too high might cause unwanted triggering.

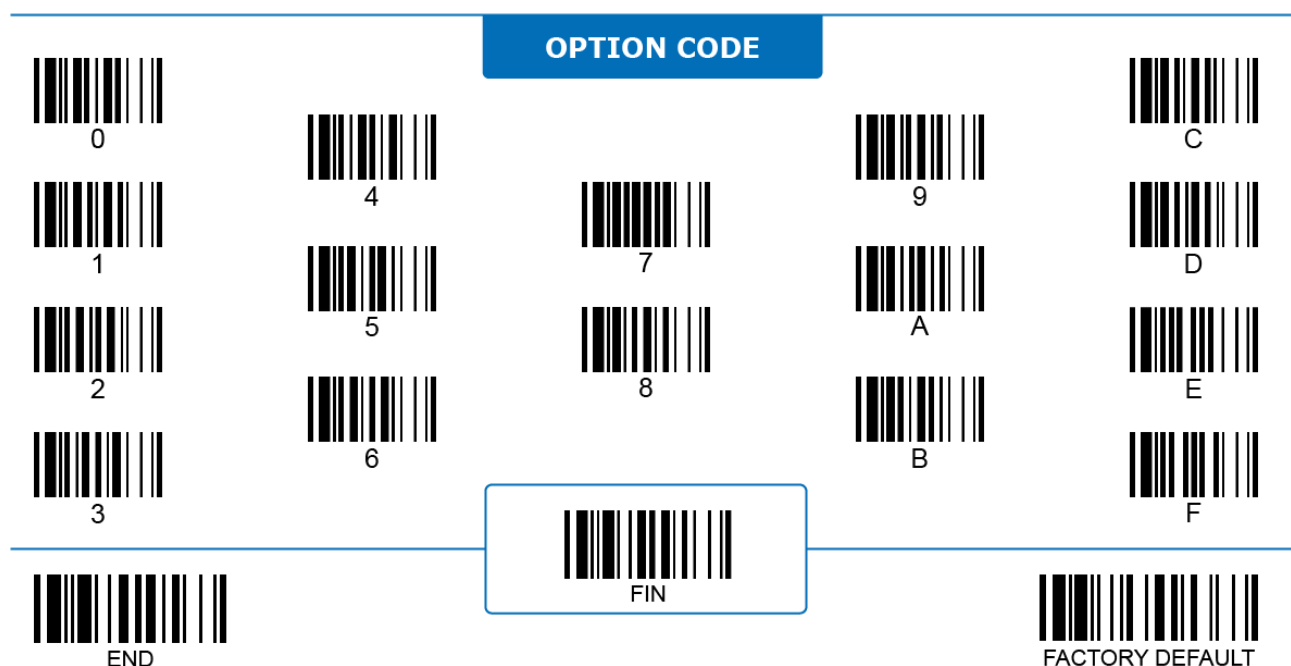

Scanner Operation

1D Barcode Inverse Reading



Program

ALL

Family Code	PP	Parameter Selection	Option Code
 1D Inverse Reading	SS	Disable ◀	0
	SS	Enable	1

1D Barcode Inverse Reading: When enabled, the scanner decodes 1D barcodes printed with light a color over a dark background.

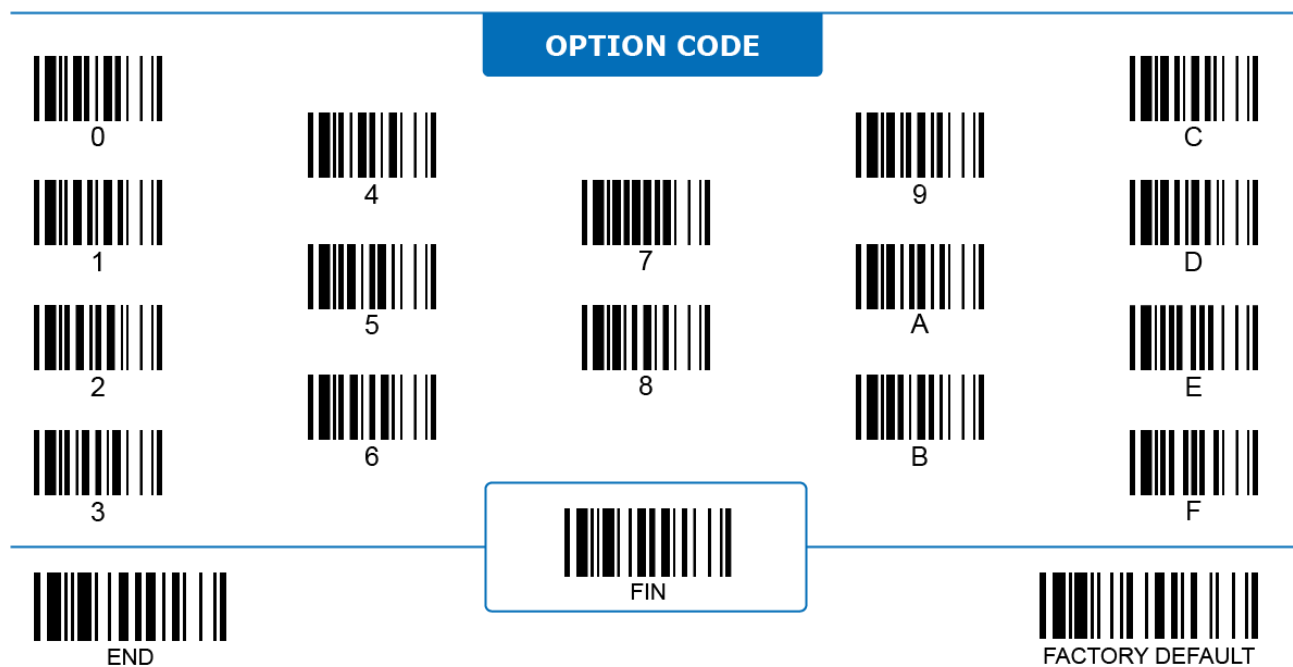

Scanner Operation

Handsfree Timeout



Program

ALL

Family Code	PP	Parameter Selection	Option Code
 Handsfree Timeout	SS	Short ◀	0
	SS	Medium	1
	SS	Long	2
	SS	Extremely long	3
	SS	Disable	4

Under handsfree operation modes such as presentation mode and force mode, the scanner automatically changes to trigger mode when its trigger button is pressed. **Handsfree Timeout** controls the duration the scanner staying in trigger mode. The timeout resets every time the trigger is pressed, and the scanner switches back to the original handsfree mode when the timeout is up.

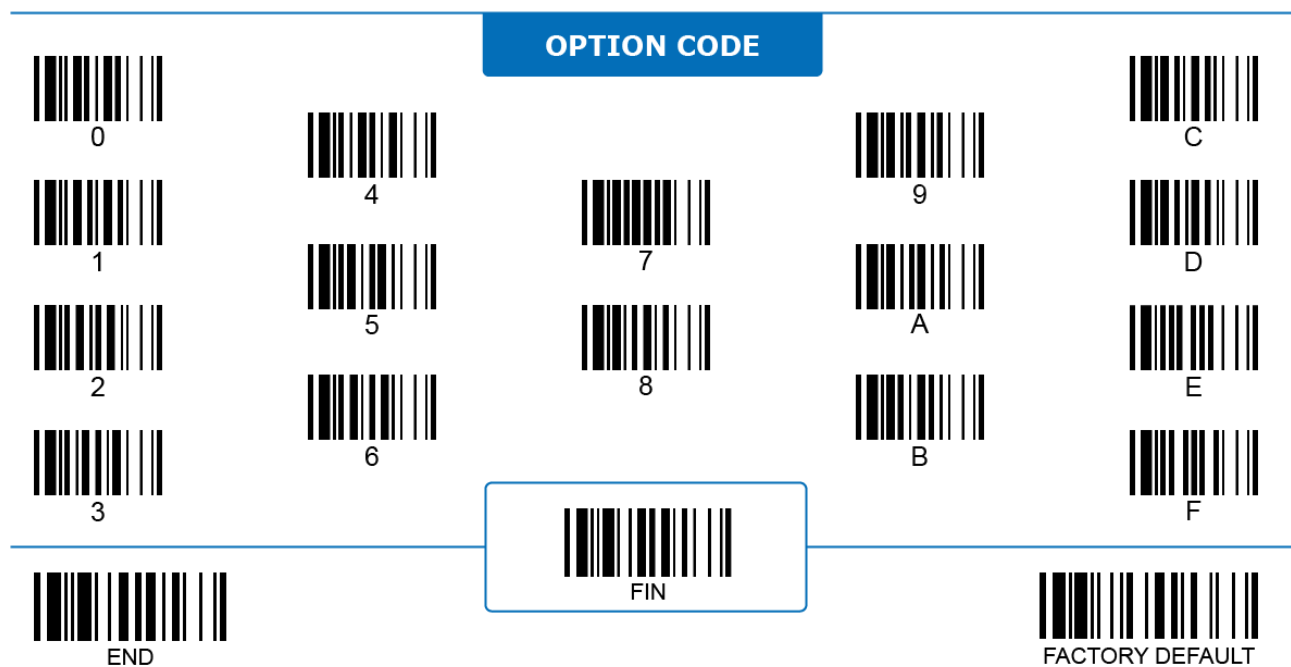

Scanner Operation

Auto-sense Control

HANDHELD



Program

Family Code	PP	Parameter Selection	Option Code
 Auto-sense Control	SS	Disable	0
	SS	Enable ◀	1

Auto-sense Control: When enabled, the scanner switches to handsfree mode automatically when a handheld corded scanner is placed on a Smart Stand, or when a handheld Bluetooth scanner is placed on a cradle.

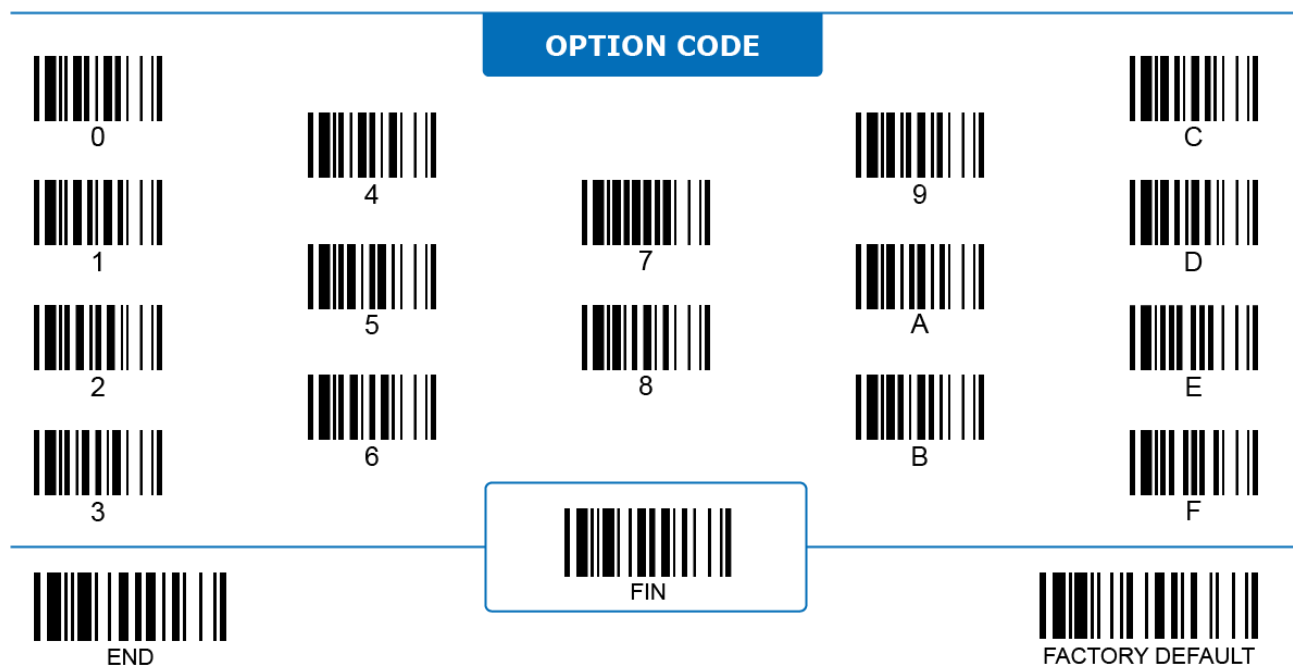

Scanner Operation

Auto-sense Mode Select

HANDHELD



Program

Family Code	PP	Parameter Selection	Option Code
 Auto-sense Mode Select	SS	Presentation mode ◀	0
	SS	Force mode	2

Auto-sense Mode Select configures which handsfree mode the scanner switches to when its Auto-sense function is enabled and triggered.

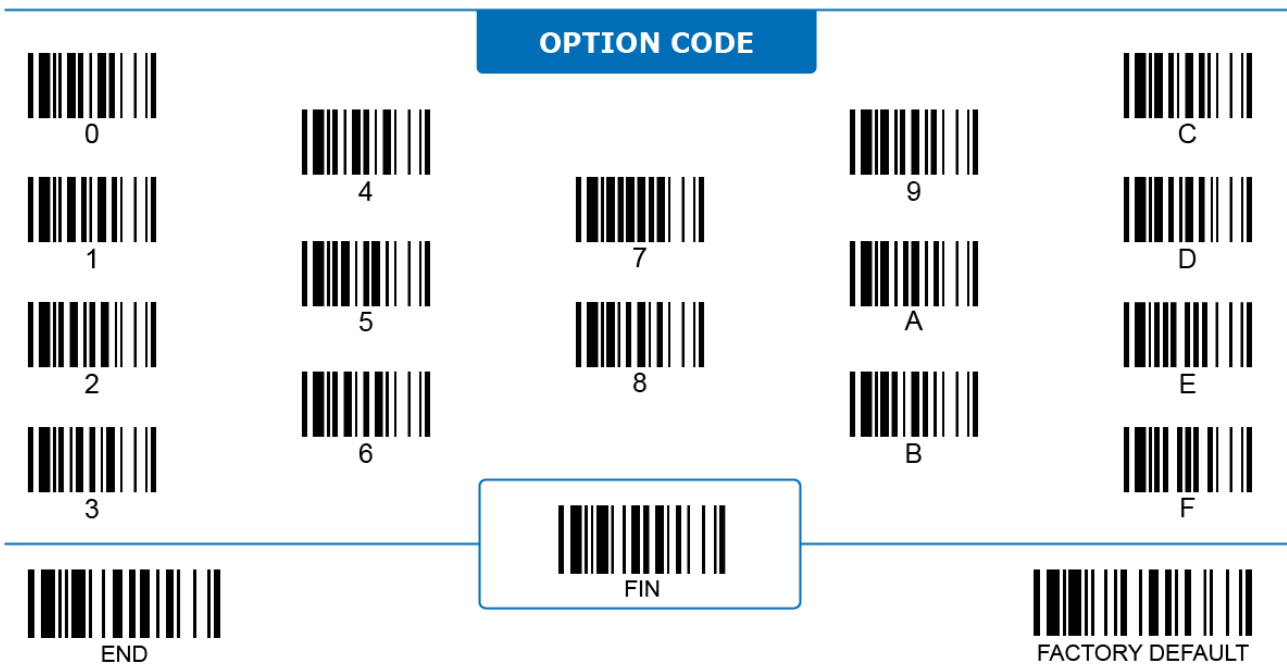

Scanner Operation

Laser Auto-sense Power Off Timeout



Program

LASER ONLY

Family Code	PP	Parameter Selection	Option Code
 Power Off Timeout	SS	3 min ◀	0
	SS	5 min	1
	SS	10 min	2

Laser Auto-sense Power-off Timeout configures how long the LED illumination of a L-series Laser corded scanner stays on when its Auto-sense function is triggered.

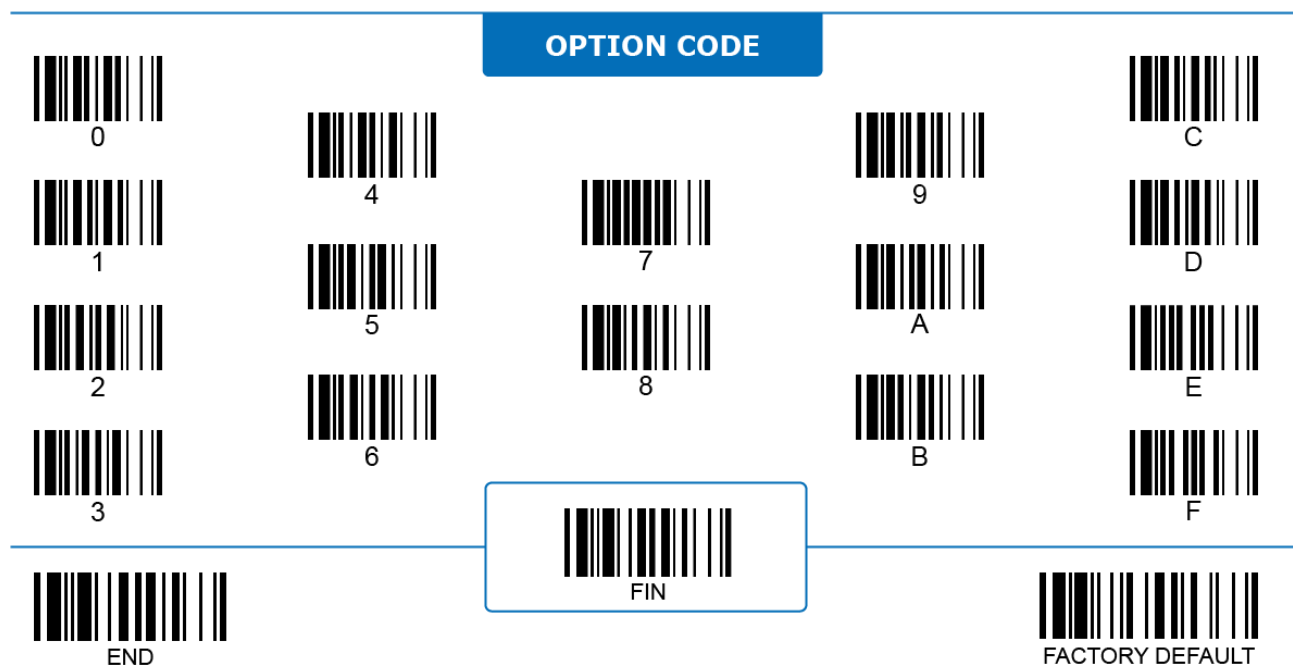

Scanner Operation

NG Message Output

FIXED MOUNT

ON COUNTER



Program

Family Code	PP	Parameter Selection	Option Code
 NG Message Output	SS	None ◀	0
	SS	Default message "NG" with CRLF	1
	MS	User-defined message (1~15 characters)	2, [00 - 7F]
Max: 15 characters. Scan "FIN" to end the selection.			

NG Message Output: When enabled, the scanner transmits a NG message when it has a No Good Read (NG) result.

For character input, refer to the **HEX to ASCII Conversion Table** below:

L \ H	0	1	2	3	4	5	6	7
0	NUL	DLE	SPACE	0	@	P	`	p
1	SOH	DC1	!	1	A	Q	a	q
2	STX	DC2	*	2	B	R	b	r
3	ETX	DC3	#	3	C	S	c	s
4	EOT	DC4	\$	4	D	T	d	t
5	ENQ	NAK	%	5	E	U	e	u
6	ACK	SYN	&	6	F	V	f	v
7	BEL	ETB	'	7	G	W	g	w
8	BS	CAN	(8	H	X	h	x
9	HT	EM)	9	I	Y	i	y
A	LF	SUB	*	:	J	Z	j	z
B	VT	ESC	+	;	K	[k	{
C	FF	FS	.	<	L	\	l	
D	CR	GS	-	=	M]	m	}
E	SO	RS	>	>	N	^	n	~
F	SI	US	/	?	O	_	o	DEL

OPTION CODE



0



4



7



9



C



1



5



8



A



D



2



6



B



E



3



FIN



F



END



FACTORY DEFAULT



Scanner Operation

Handheld & Handsfree Center Alignment





















Program

2D ONLY

Family Code	PP	Parameter Selection	Option Code
 Handheld Center Alignment	SS	Disable ◀	0
	SS	Enable ◀ (Default for On-counter scanners)	1
 Handsfree Center Alignment	SS	Disable ◀	2
	SS	Enable	3

- Handheld Center Alignment:** When enabled, the scanner only decodes barcode(s) very close to the aiming line/dot under handheld modes including trigger mode and multiple read mode.
- Handsfree Center Alignment:** When enabled, the scanner only decodes barcode(s) very close to the aiming line/dot under handsfree modes including presentation mode and force mode.

OPTION CODE

 0	 4	 7	 9	 C
 1	 5	 8	 A	 D
 2	 6	 B	 E	 F
 3	 FIN	 END		 FACTORY DEFAULT

Scanner Operation

Unique Barcode Reporting

2D ONLY



Program

Family Code	PP	Parameter Selection	Option Code
 Unique Code Reporting	SS	Disable ◀	0
	SS	Enable	1

Unique Barcode Reporting: When enabled, under multiple read mode the scanner only transmit each unique barcode One Time before the trigger is released. Unique Barcode Reporting can prevent unwanted repeated reading of the same barcode.

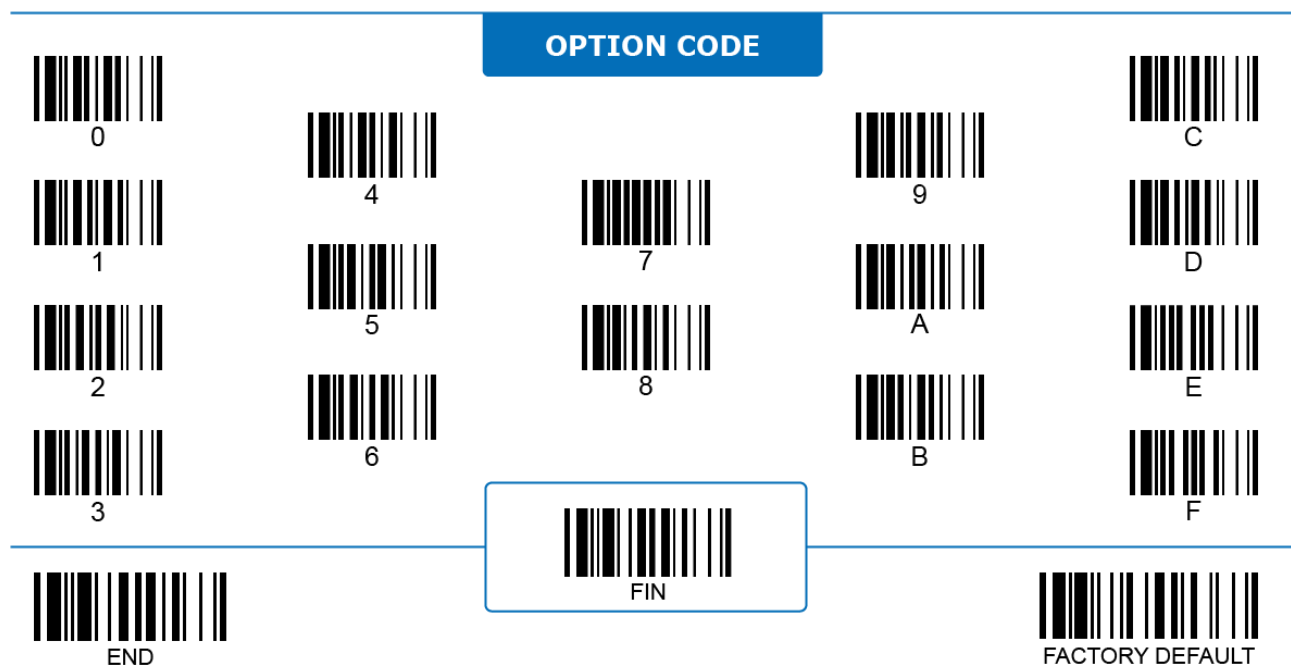

Scanner Operation

2D Smart Scene



Program

2D ONLY

Family Code	PP	Parameter Selection	Option Code
 <p>2D Smart Scene</p>	SS	Scene 1 ◀	0
	SS	Scene 2	1
	SS	Scene 3	2
	SS	Scene 4	3
	SS	Scene 5	4
	SS	Scene 6	5
	SS	Scene 7	6

2D Smart Scene provide a series of pre-defined scanner profiles optimized for different application scenarios:

- i. Scene 1 is the default setting. It optimizes the scanner for use in most working environments.
- ii. Scene 2 optimizes the scanner for reading high-density barcodes.
- iii. Scene 3 is for general retail applications.
- iv. Scene 4 is also optimized for general retail applications, as well as the performance of scanning barcodes displayed on device screens, especially those with large screens and low brightness.
- v. Scene 5 is an application-specific mode that optimizes the scanner for scanning low PCS (print contrast) barcodes on circuit boards.
- vi. Scene 6 is an application-specific mode that optimizes the scanner for scanning barcodes on circuit boards with sufficient ambient light.
- vii. Scene 7 is an application-specific mode optimizes the scanner for scanning barcodes from mobile device screens.

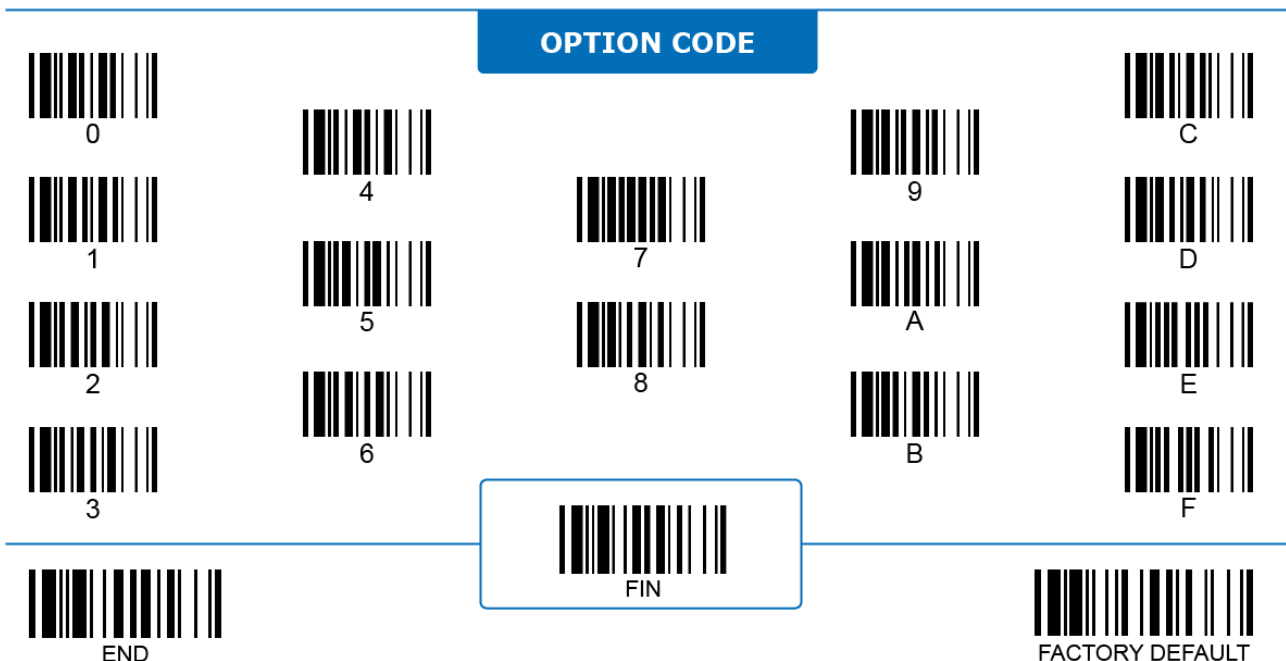

Scanner Operation

1D Reading Redundancy



Program

1D ONLY

Family Code	PP	Parameter Selection	Option Code
 <p>1D Reading Redundancy</p>	SS	None	0
	SS	Level 1 ◀	1
	SS	Level 2	2
	SS	Level 3	3
	SS	Level 4	4
	SS	Level 5	5

1. **1D Reading Redundancy** is how many times a barcode has to be decoded and matches the previous result before it is transmitted. The higher the redundancy level is, the less likely a misread happens. However, higher redundancy levels reduces the scanning speed.
2. For 2D scanners, the number of reading redundancy is dynamically adjusted by the scanner and cannot be configured manually.

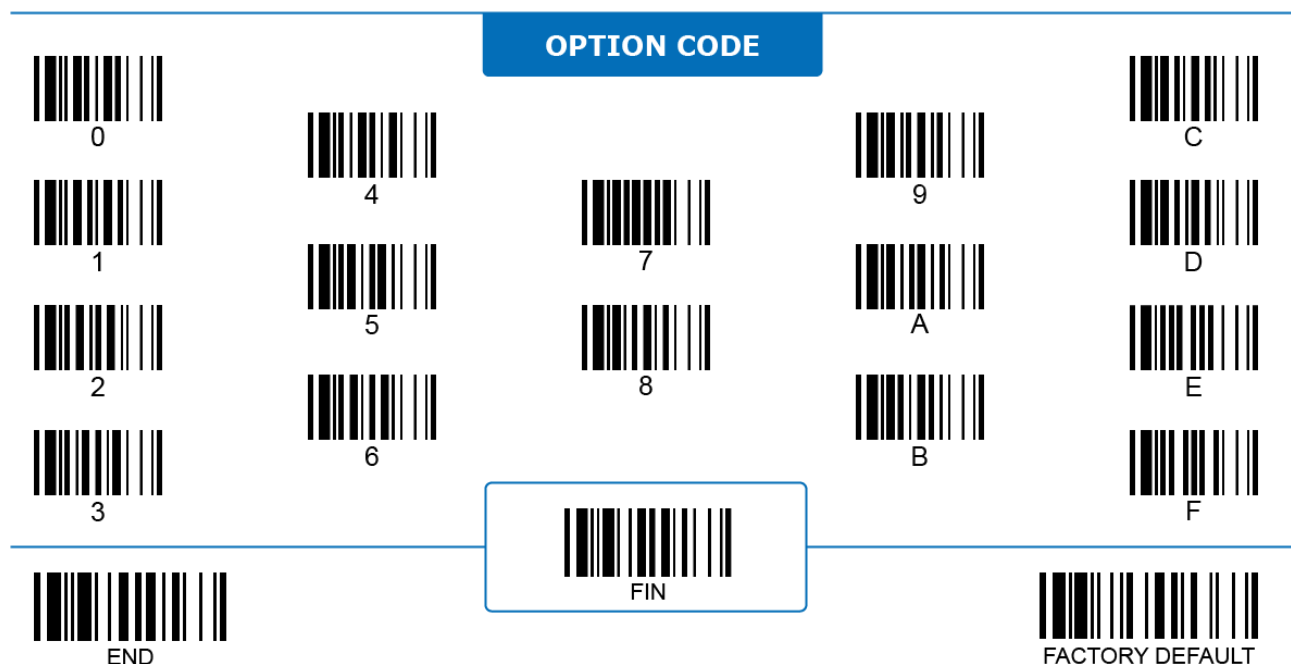

Scanner Operation

1D Scan Rate

1D ONLY



Program

Family Code	PP	Parameter Selection	Option Code
 1D Scan Rate	SS	Dynamic ◀	0
	SS	Fixed	1

1D Scan Rate: Selecting fixed scan rate to improve motion tolerance, while compromising the reading distance.

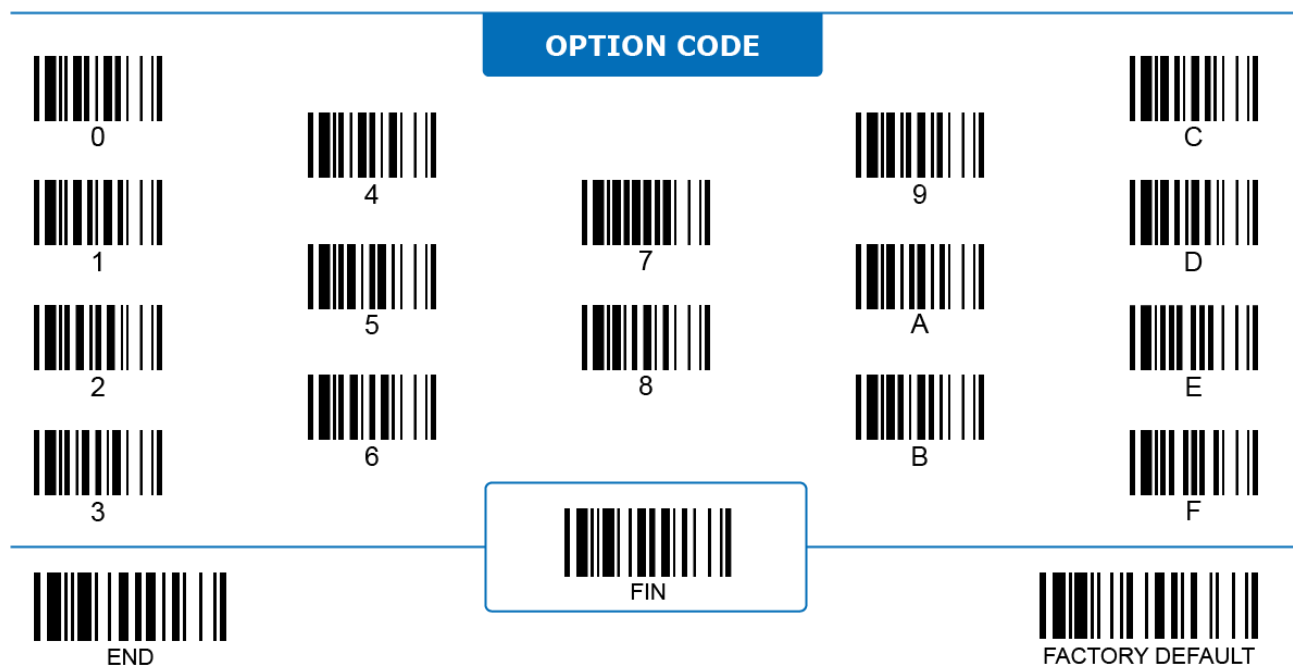

Scanner Operation

1D Reading Direction Indication

1D ONLY



Program

Family Code	PP	Parameter Selection	Option Code
 Direction Indication	SS	Disable ◀	0
	SS	Transmit direction character as prefix	1
	SS	Transmit direction character as suffix	2
	SS	Transmit direction character as prefix and suffix	3

1D Reading Direction Indication: When enabled, the scanner attaches specified prefix and/or suffix characters to decoded data according to the reading direction of a 1D barcode, to identify whether the barcode is in its normal or reversed position.

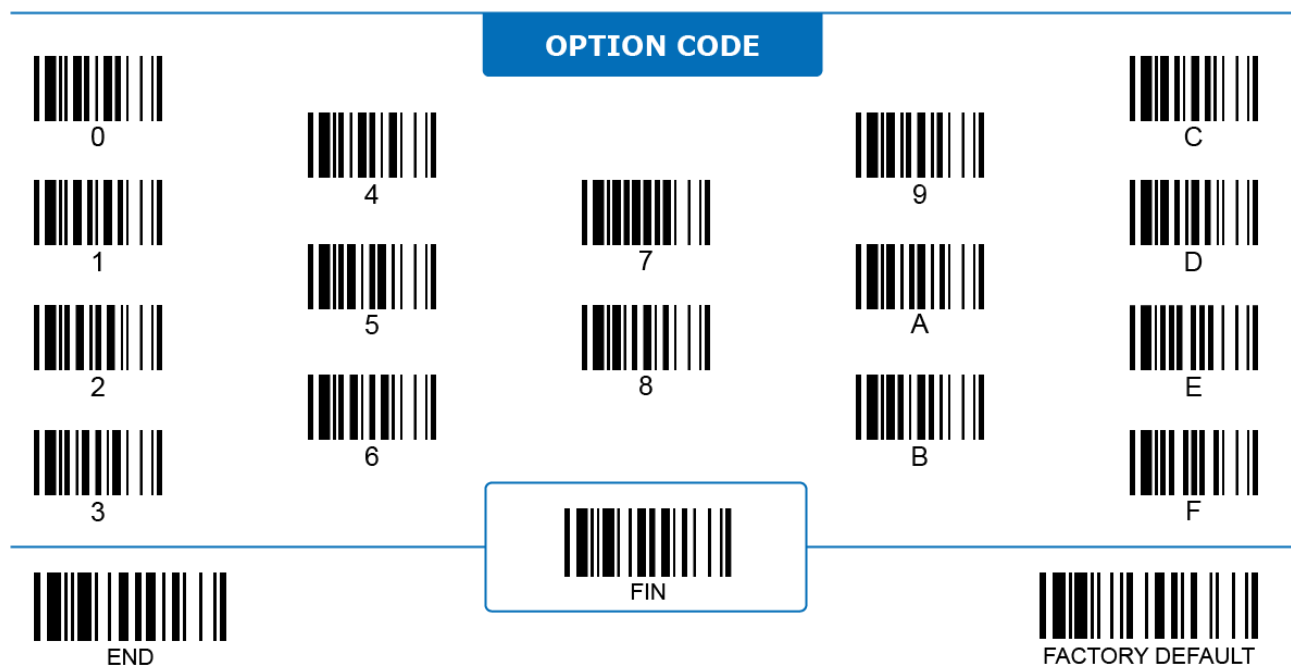



Scanner Operation

1D Barcode Forward/Backward-reading Indication

1D ONLY



Program

Family Code	PP	Parameter Selection	Option Code
 <p>Forward-read Indication</p>	SS	None ◀	0
	SS	"S"	1
	MS	User-defined character (1 character)	2 [00-7F]
 <p>Backward-read Indication</p>	SS	None	0
	SS	"X" ◀	1
	MS	User-defined character (1 character)	2 [00-7F]

1D Barcode Forward/Backward-reading Indication defines the characters attached and transmitted with the main data to identify the barcode direction.

For character input, refer to the **HEX to ASCII Conversion Table** below:

L \ H	0	1	2	3	4	5	6	7
0	NUL	DLE	SPACE	0	@	P	`	p
1	SOH	DC1	!	1	A	Q	a	q
2	STX	DC2	"	2	B	R	b	r
3	ETX	DC3	#	3	C	S	c	s
4	EOT	DC4	\$	4	D	T	d	t
5	ENQ	NAK	%	5	E	U	e	u
6	ACK	SYN	&	6	F	V	f	v
7	BEL	ETB	'	7	G	W	g	w
8	BS	CAN	(8	H	X	h	x
9	HT	EM)	9	I	Y	i	y
A	LF	SUB	*	:	J	Z	j	z
B	VT	ESC	+	;	K	[k	{
C	FF	FS	,	<	L	\	l	
D	CR	GS	-	=	M]	m	}
E	SO	RS	.	>	N	^	n	~
F	SI	US	/	?	O	_	o	DEL

OPTION CODE



0



4



7



9



C



1



5



8



A



D



2



6



FIN



B



E



END



FACTORY DEFAULT

Scanner Operation

OK/NG Signal Output

FIXED MOUNT





















Program

Family Code	PP	Parameter Selection	Option Code
 <p>Signal Output</p>	SS	Disable OK output; disable NG output; disable OK/NG indicators ◀	0
	SS	Disable OK output; enable NG output ; disable OK/NG indicators	1
	SS	Enable OK output ; disable NG output; disable OK/NG indicators	2
	SS	Enable OK output ; enable NG output ; disable OK/NG indicators	3
	SS	Disable OK output; enable NG output ; enable NG indicator	4
	SS	Enable OK output ; disable NG output; enable OK indicator	5
	SS	Enable OK output ; enable NG output ; enable OK/NG indicators	6
	SS	Disable OK output; disable NG output; enable NG indicator	7
	SS	Disable OK output; disable NG output; enable OK indicator	8
	SS	Disable OK output; disable NG output; enable OK/NG indicators	9
Signal outputs are only available on scanner with Universal interface.			

- OK/NG Signal Output:** when enabled, the scanner sends out a electrical signal through either its OK output pin or NG output pin according to the result of each decode session (Good Read or No Good Read). It is only effective in operation modes with the timeout function enabled.
- OK/NG Indicators:** when enabled, the scanner emits a LED indicator according to the result of each decode session. It is only effective in operation modes with timeout function enabled.
- OK/NG signal outputs are only available on scanners with a Universal Interface. These include FA480-9, FA470-9, FA460-9, FM480-9, SM5800-9, SM5600-9, and SM380-9.
- OK/NG indicators are available on all fixed mount scanner models.

OPTION CODE

 0	 4	 7	 9	 C
 1	 5	 8	 A	 D
 2	 6	 B	 E	 F
 3	<div style="border: 1px solid blue; padding: 5px; display: inline-block;">  FIN </div>			
 END			 FACTORY DEFAULT	

Scanner Operation

OK/NG Signal Active State

FIXED MOUNT



Program

Family Code	PP	Parameter Selection	Option Code
 Signal Active State	SS	Set OK low; set NG low ◀	0
	SS	Set OK low; set NG high	1
	SS	Set OK high; set NG low	2
	SS	Set OK high; set NG high	3
		<i>Only available on scanner with Universal Interface.</i>	

- OK/NG Signal Active State** configures the logic level of the active state of OK / NG signal output. The scanner works as a NPN (sinking) device through OK and NG signal output pins.
- Scanners with a Universal Interface include FA480-9, FA470-9, FA460-9, FM480-9, SM5800-9, SM5600-9, and SM380-9.

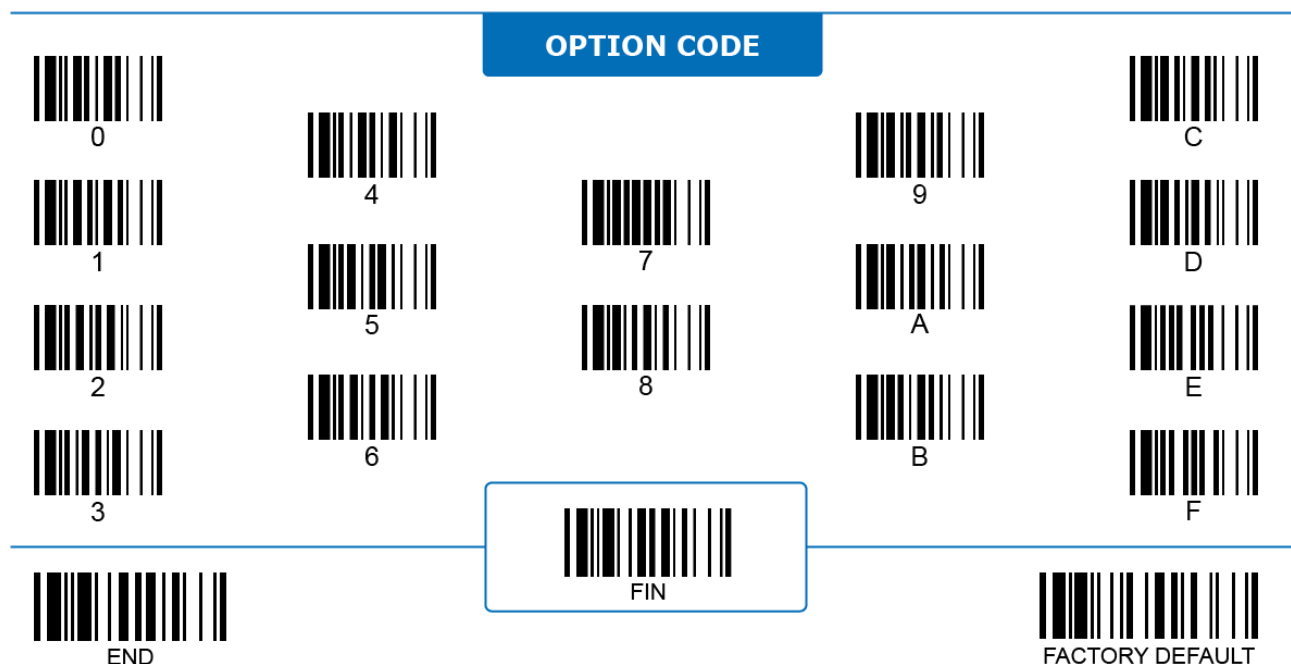

Scanner Operation

OK/NG Signal Duration

FIXED MOUNT



Program

Family Code	PP	Parameter Selection	Option Code	
 OK/NG Signal Duration	SS	10 ms	0	
	SS	20 ms	1	
	SS	30 ms	2	
	SS	40 ms	3	
	SS	50 ms	4	
	SS	60 ms	5	
	SS	70 ms	6	
	SS	80 ms	7	
	SS	90 ms	8	
	SS	100 ms ◀	9	
	MS	User-defined: 1 – 99 (x50) ms		A, (2 digits)

OK/NG Signal Duration configures the duration of OK/NG signal outputs and OK/NG LED indications.

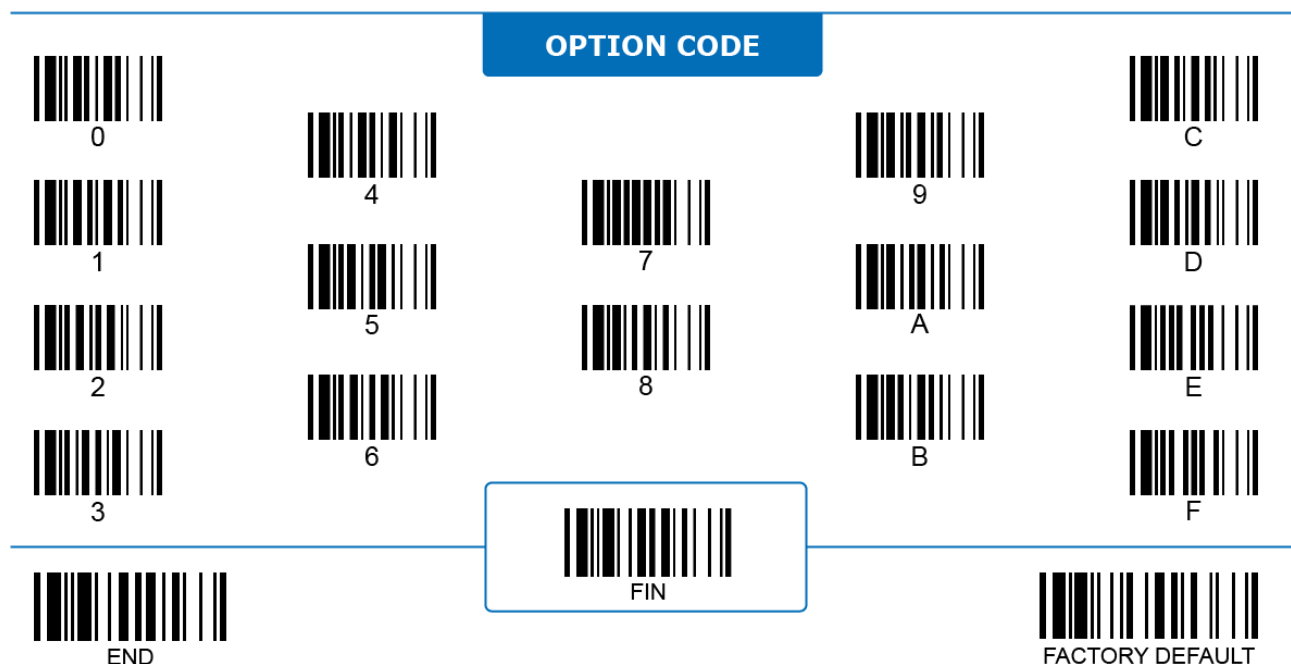



Scanner Light Control

2D Illumination & Aiming Control

2D ONLY





















Program

Family Code	PP	Parameter Selection	Option Code
 2D Handheld Illumination & Aiming Control	SS	Disable illumination; disable aiming	0
	SS	Disable illumination; enable aiming	1
	SS	Enable illumination; disable aiming	2
	SS	Enable illumination; enable aiming ◀	3
 2D Handsfree Illumination & Aiming Control	SS	Disable illumination; disable aiming	0
	SS	Disable illumination; enable aiming	1
	SS	Enable illumination; disable aiming ◀ (On-counter Scanners)	2
	SS	Enable illumination; enable aiming ◀	3

1. **2D Handheld Illumination & Aiming Control** configures the on/off of the illumination LED and aiming LED under trigger mode or multiple read mode.
2. **2D Handsfree Illumination & Aiming Control** configures the on/off of the illumination LED and aiming LED under presentation mode or force mode.

OPTION CODE

 0	 4	 7	 9	 C
 1	 5	 8	 A	 D
 2	 6	 B	 E	 F
 3	<div style="border: 1px solid blue; padding: 5px; display: inline-block;">  FIN </div>			
 END			 FACTORY DEFAULT	



Scanner Light Control

2D Aiming Select, Pre-decode Aiming Timeout



Program

2D ONLY

Family Code	PP	Parameter Selection	Option Code
 2D Aiming Select	SS	Regular Aiming ◀(Default for Bluetooth scanners)	0
	SS	Intelligent Aiming ◀(Default for Corded & On-counter scanners)	1
	SS	Pre-decode Aiming	2
 2D Pre-decode Aiming Timeout	SS	200 ms	0
	SS	400 ms ◀	1
	SS	800 ms	2
	SS	1 sec	3
	SS	1.5 sec	4
	SS	2 sec	5
	SS	3 sec	6
	SS	4 sec	7

- 2D Aiming Select** configures the 2D scanner behavior of aiming line/dot with the following 3 options:
 - Regular Aiming:** Aiming line/dot is turned on only when the trigger is pressed.
 - Intelligent Aiming:** Aiming line/dot is turned on when the user lifts up the scanner, or when the scanner detects any movement in front of it.
 - Pre-decode Aiming** provides a duration for the user to aim at the target barcode before the scanner turns on its LED illumination and starts to decode the barcode. The aiming line/dot stays on during **Pre-decode Aiming Timeout**. This mode is recommended when decoding many barcodes which are packed in a close distance. This option is only available under Trigger mode.
- 2D Aiming Selection is only available under Trigger mode and Multiple read mode.
- 2D Pre-decode Aiming Timeout** configures how long the duration is when the 2D scanner turns on its aiming line/dot before the decode session begins.

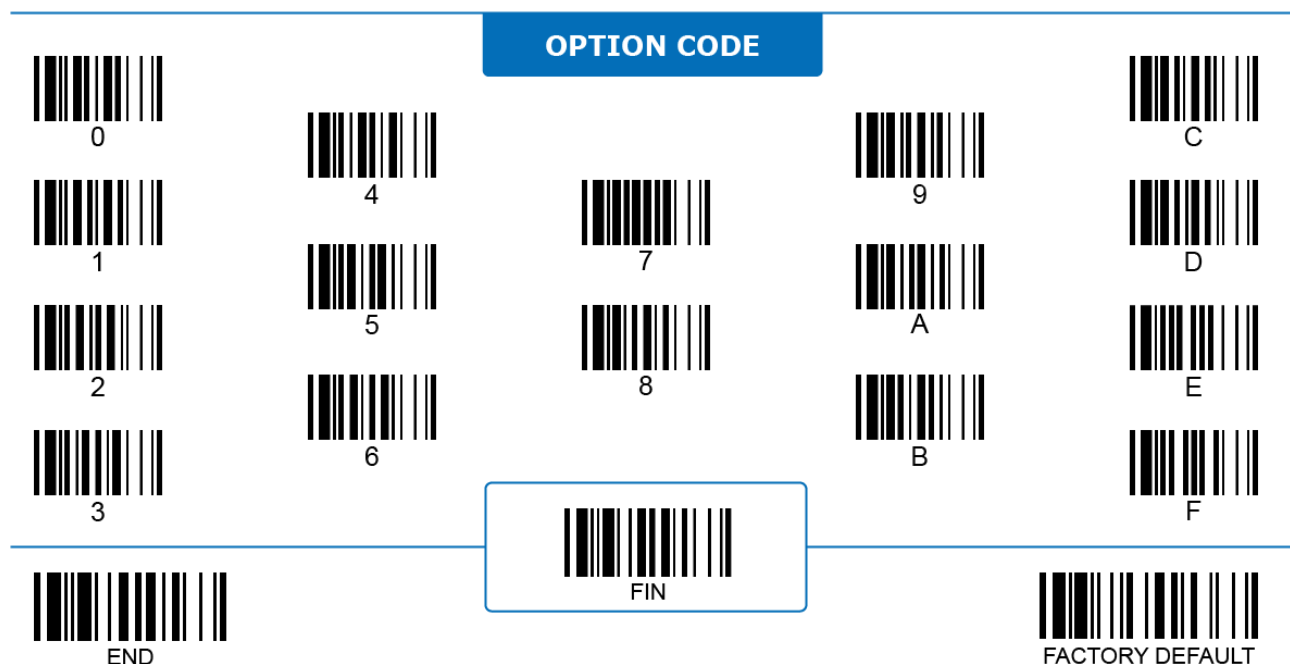

Scanner Light Control

Laser Aiming Control



Program

LASER ONLY

Family Code	PP	Parameter Selection	Option Code
 Laser Aiming Control	SS	Disable	0
	SS	Enable ◀	1

Laser Aiming Control: When disabled, the scanner turns off its Laser aiming line but keeps the LED illumination on when it is triggered. Disable Laser aiming line can improve the reading of stacked **PDF417** and **Micro PDF417** codes.

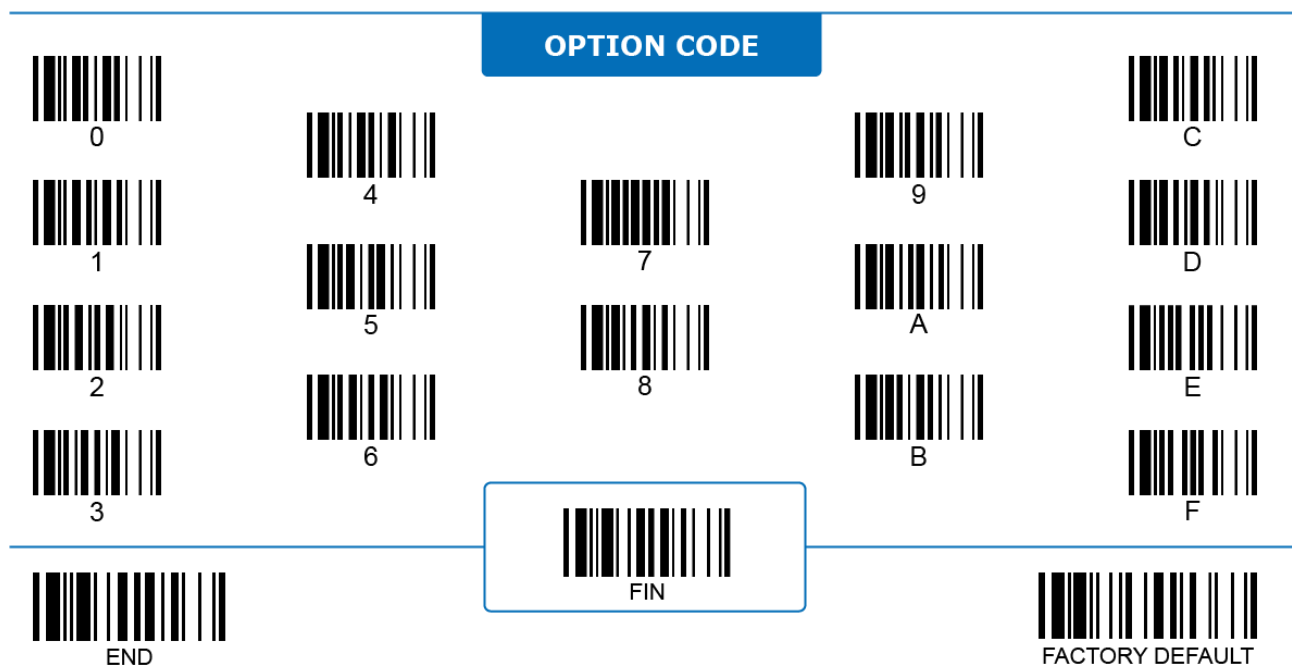



Scanner Light Control

Laser Aiming Select, Pre-decode Aiming Timeout



Program

LASER ONLY

Family Code	PP	Parameter Selection	Option Code
 Laser Aiming Select	SS	Regular aiming ◀	0
	SS	Pre-decode aiming	1
 Pre-decode Aim Timeout	SS	100 ms	0
	SS	150 ms ◀	1
		200 ms	2
		250 ms	3
		300 ms	4

- Laser Aiming Select** configures the aiming line/dot behavior of L-series Laser scanners with following 2 options:
 - Regular Aiming:** Aiming line/dot is turned on only when the trigger is pressed.
 - Pre-decode Aiming** provides a duration for the user to aim at the target barcode before the scanner turns on its LED illumination and starts to decode the barcode. The aiming line/dot keeps on during **Laser Pre-decode Aiming Timeout**. This mode is recommended when decoding many barcodes pack in a close distance. This option is only available under Trigger mode.
- Laser Aiming Selection is only available under Trigger mode and Multiple read mode.
- Laser Pre-decode Aiming Timeout** configures the length of time the laser scanner turns on its aiming line/dot before the decode session begins.

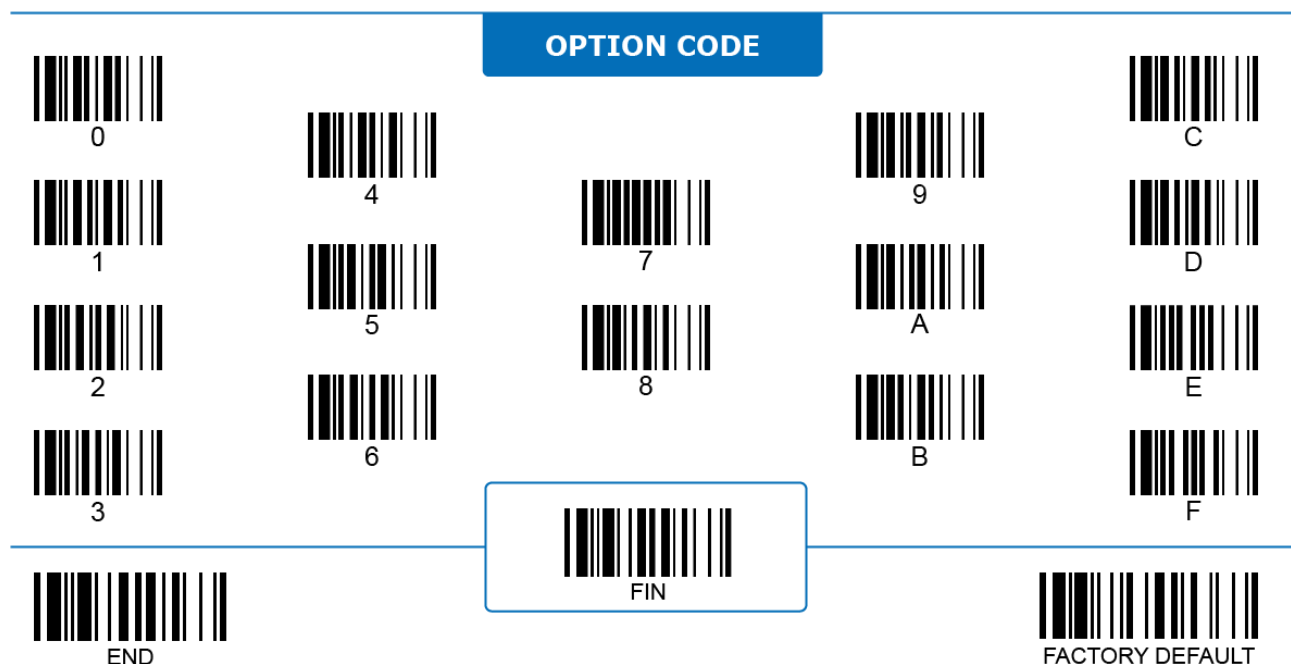



User Interactions

Buzzer Tone, Buzzer Volume



Program

ALL

Family Code	PP	Parameter Selection	Option Code
 Buzzer Tone	SS	Low (Frequency 1.20 kHz)	1
	SS	Medium (Frequency 2.70 kHz) ◀	2
	SS	High (Frequency 2.81 kHz)	3
	SS	Extremely high (Frequency 2.93 kHz)	4
 Buzzer Volume	SS	Low	0
	SS	Medium	1
	SS	High ◀	2

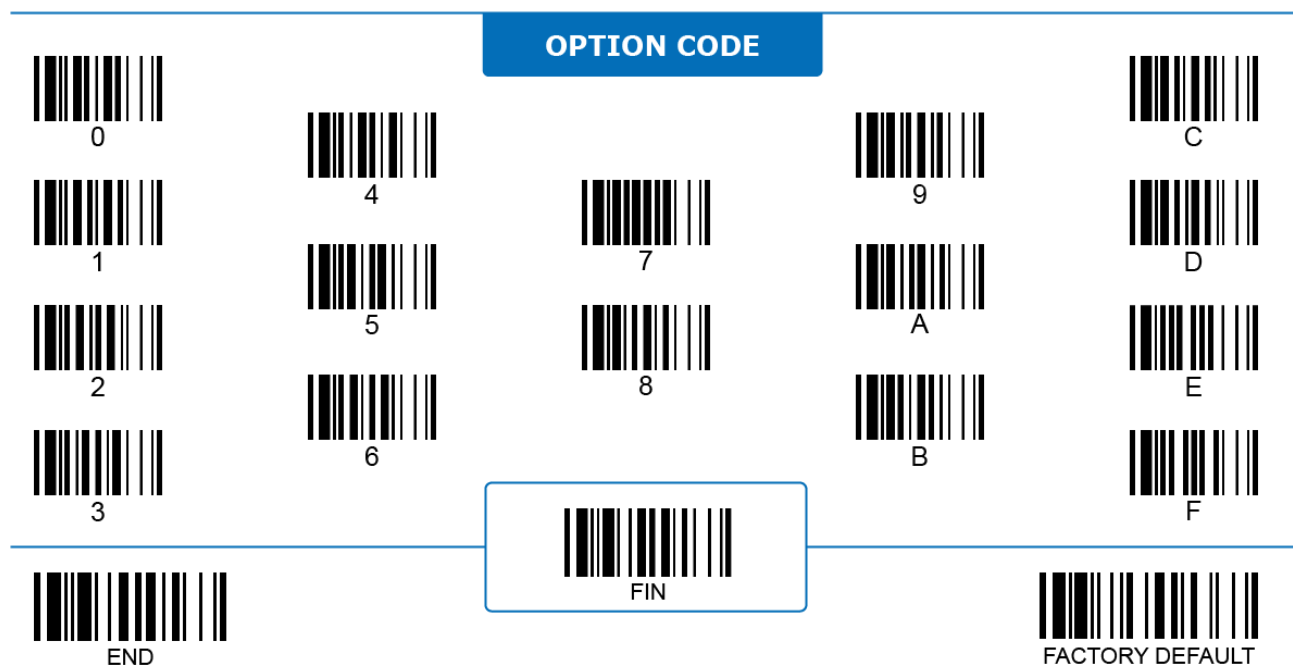

User Interactions

Good Read Beeping

HANDHELD



Program

Family Code	PP	Parameter Selection	Option Code
 Good Read Beeping	SS	Disable	0
	SS	Enable ◀	7

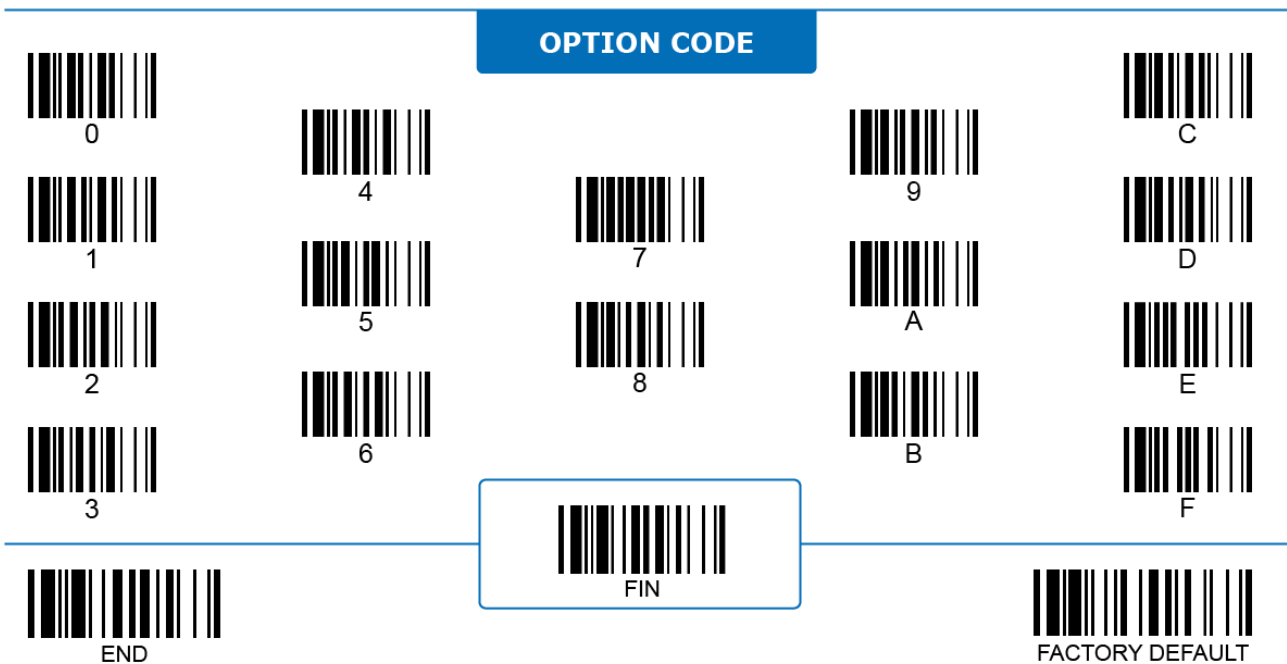

User Interactions

Power On/Off Beeping



Program

ALL

Family Code	PP	Parameter Selection	Option Code
 Power On/Off Beeping	SS	Enable ◀	5
	SS	Disable	6
<p>Power off beep is only available on cordless Bluetooth scanners.</p>			

Power On/Off Beeping: When enabled, the scanner emits a beeping sound right after it is powered on. Cordless Bluetooth scanners also emit an additional beeping sound before being powered off.

OPTION CODE



User Interactions

Good Read Indicator, Power-on Indicator



Program

ALL

Family Code	PP	Parameter Selection	Option Code
 Good Read Indicator.	SS	Disable	0
	SS	Enable ◀	1
 Power-on Indicator	SS	Disable	0
	SS	Enable with LED steady on ◀	1
	SS	Enable with LED flashing	2
A560, F560, and all BT scanners do not support this function.			

Power-on Indicator: When enabled, the scanner turns on its blue LED indicator to disclose that it is currently powered.

OPTION CODE



User Interactions
Vibration Control



Program

ALL

Family Code	PP	Parameter Selection	Option Code
 Vibration Control	SS	Disable	0
	SS	Enable ◀	1
<p>Option available on models with the vibration function.</p>			

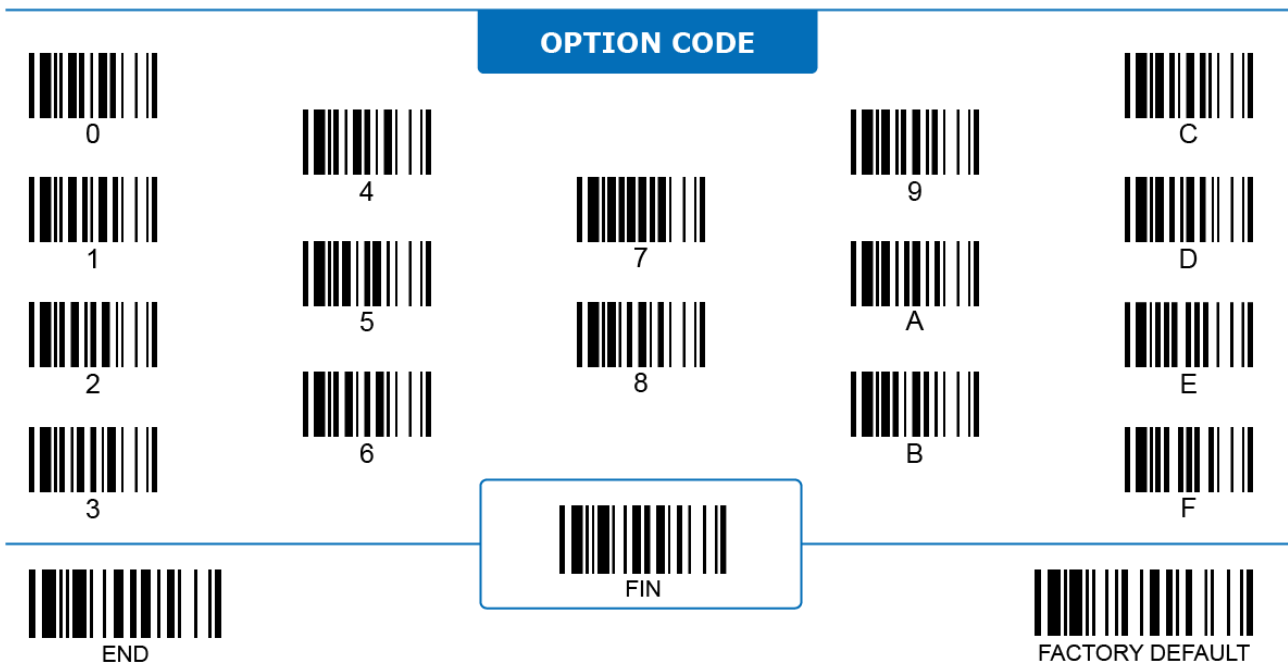

User Interactions

Good Read Duration



Program

ALL

Family Code	PP	Parameter Selection	Option Code
 Good Read Duration	SS	Short	0
	SS	Medium ◀	1
	SS	Long	2
	SS	Extreme long	3
	SS	Extreme short	4

Good Read Duration is the duration of a good read beep.

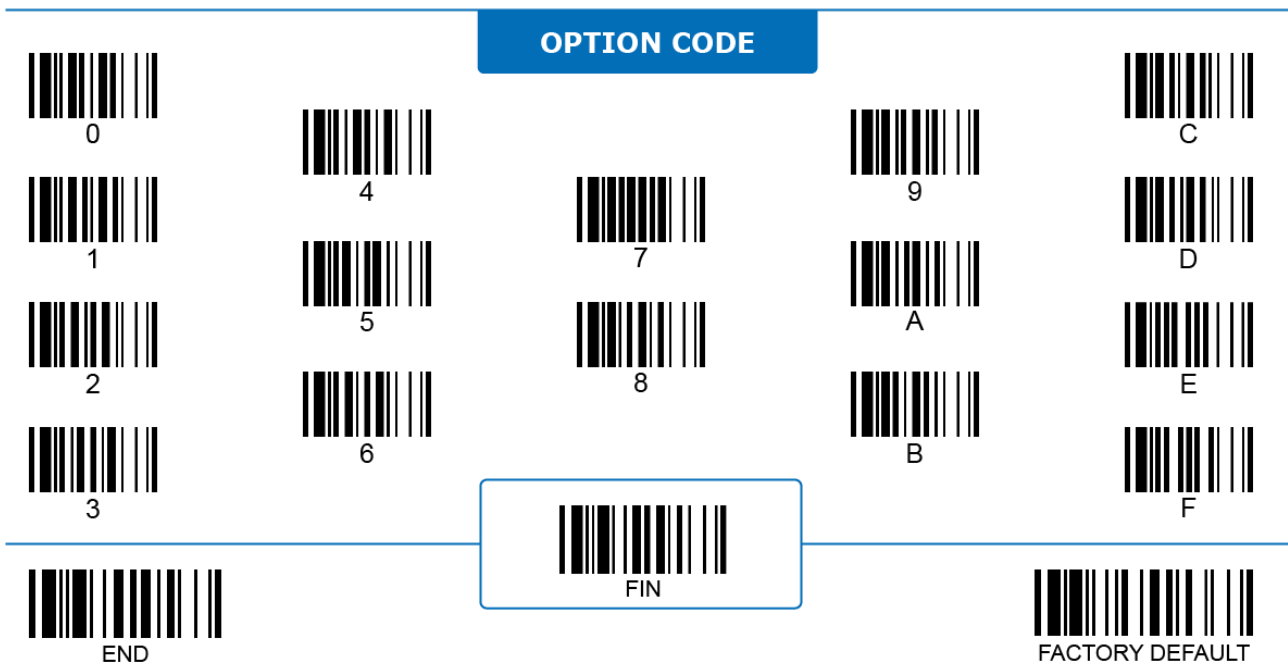

User Interactions

OK/NG Beeping

FIXED MOUNT

ON COUNTER



Program

Family Code	PP	Parameter Selection	Option Code
<p>OK/NG Beeping</p>	SS	Disable OK beep; disable NG beep	0
	SS	Enable OK beep; enable NG beep	1
	SS	Enable OK beep; disable NG beep ◀	2
	SS	Disable OK beep; enable NG beep	3

OK/NG Beeping: When enabled, the scanner emits the corresponding buzzer beep according to the result of each decode session (Good Read or No Good Read).

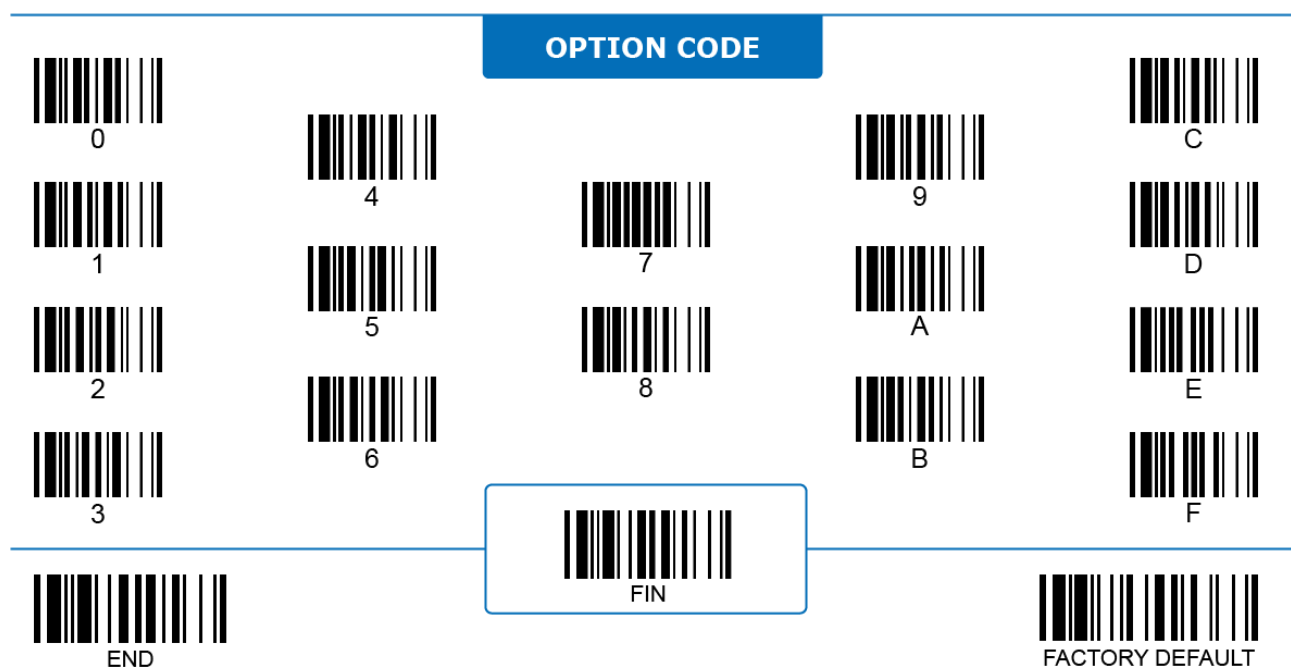

6 BLUETOOTH SETTINGS

The information contained in this chapter pertains to the Bluetooth-related settings of **FuzzyScan cordless scanners only**. Presented herein are the parameters for the exclusive functions of Bluetooth models, (such as batch scanning and validation scanning), as well as general Bluetooth settings related to the device name, security, radio link and time-out.

General Bluetooth Settings

BT Device Name



Program

Family Code	PP	Parameter Selection	Option Code
 BT Device Name	SS MS	Default device name ◀ User-defined F, L, PF, and PL series: 1-16 characters A and PA series: 1-32 characters	FIN [00-7F], FIN

Default BT Device Name differs according to product series:

- i. **F series, L series, PF series, and PL series:** "FxxxBT-xxxx", "LxxxBT-xxxx", "PFxxxBT-xxxx" and "PLxxxBT-xxxx".
- ii. **A series and PA series:** "AxxxBT-xxxx", "PAxxxBT-xxxx".

For character input, refer to the **HEX to ASCII Conversion Table** below:

L \ H	0	1	2	3	4	5	6	7
0	NUL	DLE	SPACE	0	@	P	`	p
1	SOH	DC1	!	1	A	Q	a	q
2	STX	DC2	"	2	B	R	b	r
3	ETX	DC3	#	3	C	S	c	s
4	EOT	DC4	\$	4	D	T	d	t
5	ENQ	NAK	%	5	E	U	e	u
6	ACK	SYN	&	6	F	V	f	v
7	BEL	ETB	'	7	G	W	g	w
8	BS	CAN	(8	H	X	h	x
9	HT	EM)	9	I	Y	i	y
A	LF	SUB	*	:	J	Z	j	z
B	VT	ESC	+	;	K	[k	{
C	FF	FS	,	<	L	\	l	
D	CR	GS	-	=	M]	m	}
E	SO	RS	.	>	N	^	n	~
F	SI	US	/	?	O	_	o	DEL

OPTION CODE

0

4

7

9

C

1

5

8

A

D

2

6

B

E

3

FIN

F

END

FACTORY DEFAULT

General Bluetooth Settings

BT PIN Code



Program

Family Code	PP	Parameter Selection	Option Code
 BT PIN Code	SS	Default PIN code as "00000000" ◀	FIN [30-39], FIN
	MS	User-defined PIN code, 1 to 8 numbers Input PIN code by scanning HEX values (1-8 numbers), then scan FIN to finish the process.	

For character input, refer to the **HEX to ASCII Conversion Table** below:

L \ H	0	1	2	3	4	5	6	7
0	NUL	DLE	SPACE	0	@	P	`	p
1	SOH	DC1	!	1	A	Q	a	q
2	STX	DC2	*	2	B	R	b	r
3	ETX	DC3	#	3	C	S	c	s
4	EOT	DC4	\$	4	D	T	d	t
5	ENQ	NAK	%	5	E	U	e	u
6	ACK	SYN	&	6	F	V	f	v
7	BEL	ETB	'	7	G	W	g	w
8	BS	CAN	(8	H	X	h	x
9	HT	EM)	9	I	Y	i	y
A	LF	SUB	*	:	J	Z	j	z
B	VT	ESC	+	;	K	[k	{
C	FF	FS	.	<	L	\	l	
D	CR	GS	-	=	M]	m	}
E	SO	RS	.	>	N	^	n	~
F	SI	US	/	?	O	_	o	DEL

OPTION CODE



0



4



9



C



1



5



7



D



2



6



8



A



E



3

B

F

END

FIN



FACTORY DEFAULT

General Bluetooth Settings

BT Discoverable Protocol Selection





















Program

Family Code	PP	Parameter Selection	Option Code
 BT Discoverable Protocol	SS	HID ◀	0
	SS	HID with Passkey	1
	SS	SPP Slave	3
	SS	Only available for PA, PF, and PL series companion scanners.	

BT Discoverable Protocol Selection configures which Bluetooth protocol the companion scanner uses when it is under discoverable mode. Press the FN1 button for 3 seconds to enter the discoverable mode.

OPTION CODE

 0	 4	 7	 9	 C
 1	 5	 8	 A	 D
 2	 6	 B	 E	 F
 3	<div style="border: 1px solid blue; padding: 5px; display: inline-block;">  FIN </div>			
 END			 FACTORY DEFAULT	

General Bluetooth Settings

BT Link Quality





















Program

Family Code	PP	Parameter Selection	Option Code
 BT Link Quality	SS	Disable ◀	0
	SS	Level 1	1
	SS	Level 2	2
	SS	Level 3	3
	SS	Level 4	4

BT Link Quality: When enabled, the reliability of the Bluetooth connection can be improved but with a shorter connection distance. This is recommended when operating the scanner near the boundary of the BT coverage zone. The higher the level is, the more reliable the connection is, and hence the shorter distance is. BT Link Quality is only available for Bluetooth SPP and Bluetooth HID protocols.

OPTION CODE

 0	 4	 7	 9	 C
 1	 5	 8	 A	 D
 2	 6	 B	 E	 F
 3	<div style="border: 1px solid blue; padding: 5px; display: inline-block;">  FIN </div>			
 END			 FACTORY DEFAULT	

General Bluetooth Settings
BT Out-of-range Scanning



Family Code	PP	Parameter Selection	Option Code
<p>BT Out-of-range Scan</p>	SS	Disable ◀	0
	SS	Enable	1

BT Out-of-range Scanning: When enabled, the scanner continues scanning when it loses radio connection with the host device.

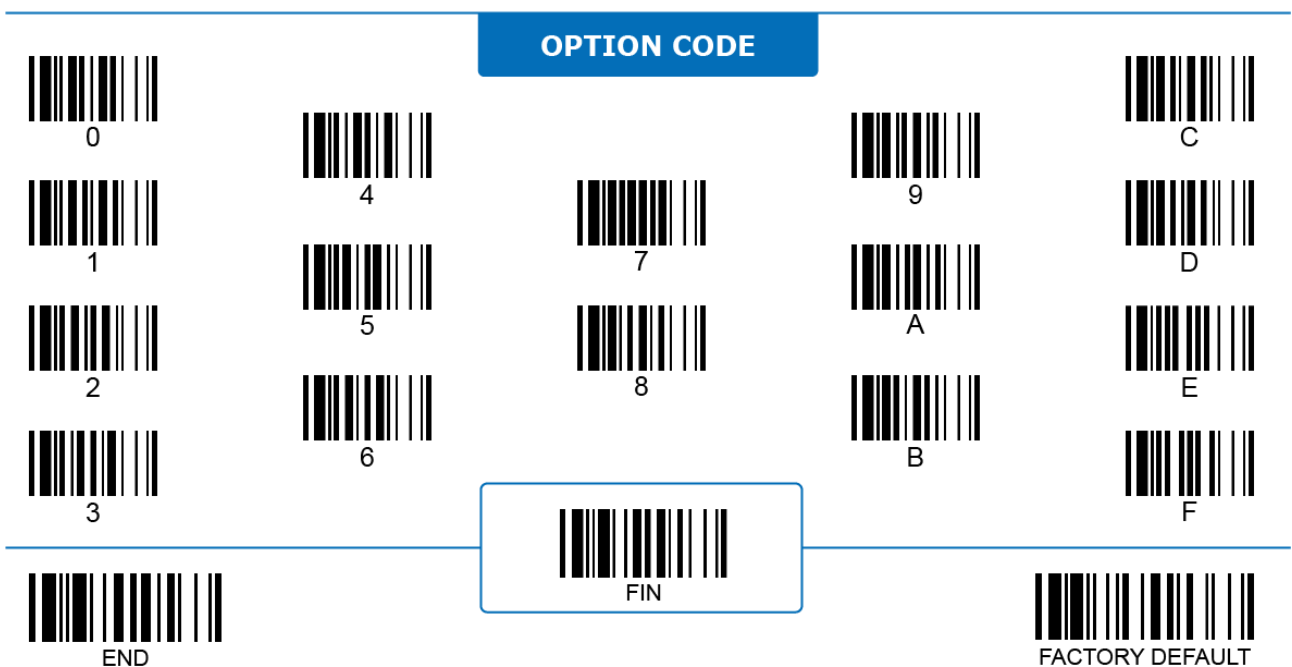

General Bluetooth Settings

BT Radio Off Timeout, Connected & Disconnected



Program

Family Code	PP	Parameter Selection	Option Code
 BT Radio off Timeout, Connected	SS Disabled SS 60 minutes ◀ MS 1-99 (x5) minutes		0 FIN (2 digits)
 BT Radio off Timeout, Disconnected	SS Disabled SS 1 minute ◀ MS 1-99 minutes		0 FIN (2 digits)

1. **BT Radio off Timeout, Connected:** When enabled, the scanner automatically turns off its BT connection to save power if its trigger has not been pressed for the preset time duration. If the connection between the scanner and its host exists, the preset timeout is controlled by “**BT Radio off Timeout, Connected**” parameter.
2. **BT Radio off Timeout, Disconnected:** When enabled, the scanner automatically turns off its BT connection to save power if its trigger has not been pressed for the preset time duration. If the connection between the scanner and its host does not exist, the preset timeout is controlled by “**BT Radio off Timeout, Disconnected**” parameter, which is shorter than the timeout of the connected condition.

OPTION CODE

 0	 4	 7	 9	 C
 1	 5	 8	 A	 D
 2	 6	 B	 E	 F
 3	 FIN			
 END	 FIN			
		 FACTORY DEFAULT		

General Bluetooth Settings

BT Power off Timeout























Program

Family Code	PP	Parameter Selection	Option Code
 BT Power off Timeout	SS	Immediately	0
	SS	5 minutes ◀	FIN
	MS	1-99 (x5) minutes	(2 digits)

BT Power off Timeout: When enabled, the scanner automatically turns itself off when its radio link with the host device is not established before the preset timeout is due. Press the trigger to turn on the scanner again.

OPTION CODE

 0	 4	 7	 9	 C
 1	 5	 8	 A	 D
 2	 6	 FIN	 B	 E
 3	<div style="border: 1px solid blue; padding: 5px; display: inline-block;">  FIN </div>			 F
 END				 FACTORY DEFAULT

General Bluetooth Settings
BT On-screen Keyboard



Program

Family Code	PP	Parameter Selection	Option Code
 BT On-screen Keyboard	SS	iOS approach	0
	SS	General approach ◀	1



















1. **BT On-screen Keyboard** provides a way to toggle the primary keyboard of the host device between its own on-screen keyboard and a connected scanner. This function is supported by **most popular devices**. Select “**iOS Approach**” for iOS devices, or “**General Approach**” for most Android and other devices.
2. After choosing the appropriate approach, scan the “**Switch On-Screen Keyboard**” quick set command to switch the primary keyboard to on-screen keyboard, and scan again to switch back to scanner input.



Switch On-screen Keyboard

3. For **PA, PF, and PL series** companion scanners, press the **FN1 key** briefly can also switch the primary keyboard between the generic one and the connected scanner.
4. After finish typing on on-screen keyboard, press the scanner trigger once to turn off on-screen keyboard and resume the BT connection.

OPTION CODE

 0	 4	 7	 9	 C
 1	 5	 8	 A	 D
 2	 6	 B	 E	 F
 3	 FIN	 END	 FACTORY DEFAULT	

General Bluetooth Settings
BT HID Transmit Delay



Program

Family Code	PP	Parameter Selection	Option Code
 BT HID Transmit Delay	SS MS	Disable ◀ 1-250 ms <i>After scanning the 3-digit code, the selection ends automatically.</i>	FIN (3 digits)

BT HID Transmission Delay: When enabled, the transmission of BT HID is delayed for a more secured connection. When the scanner is paired with an Android device, set the delay value to 70ms to avoid data loss.

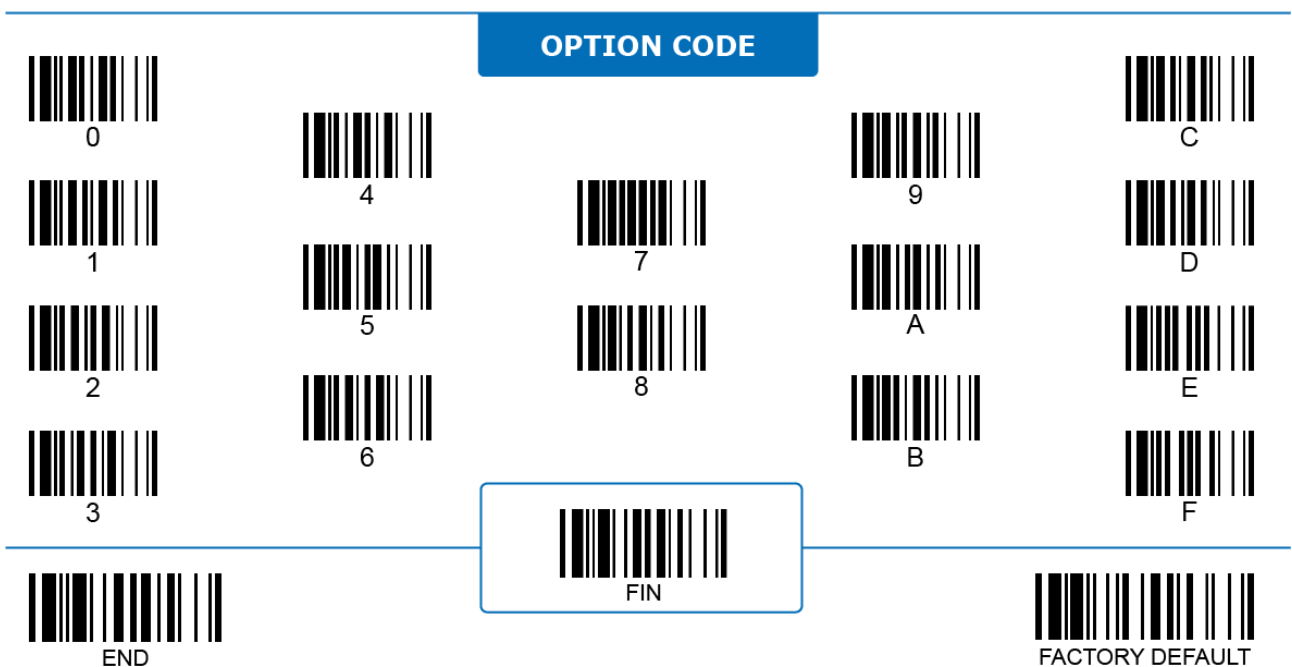



General Bluetooth Settings

BT Connect Beeping Control & Select





Program

Family Code	PP	Parameter Selection	Option Code
 Connect Beep Control	SS	Enable ◀	0
	SS	Disable	1
 Connect Beep Select	SS	Four beeps ◀	0
	SS	Two beeps	1

1. **BT Connect Beeping Control:** When enabled, the scanner emits a “connected” beep to indicate that the BT connection is established, or a “disconnected” beep to indicate that the connection is gone.
2. **BT Connect Beeping Select** configures the style of the beeping:
 - i. **Four beeps:** When selected, the scanner emits four ascending beeps for connection, and four descending beeps for disconnection.
 - ii. **Two beeps:** When selected, the scanner emits low to high beeps for connection, and high to low beeps for disconnection.

OPTION CODE



0



4



7



9



C



1



5



8



A



D



2



6



B



E

3

FIN

F



END

FACTORY DEFAULT

General Bluetooth Settings
BT Battery Low Beeping



Program

Family Code	PP	Parameter Selection	Option Code
 Battery Low Beeping	SS	Enable ◀	2
	SS	Disable	3

BT Battery Low Beeping: When enabled, the scanner emits warning beeps if the battery power is lower than a certain level.

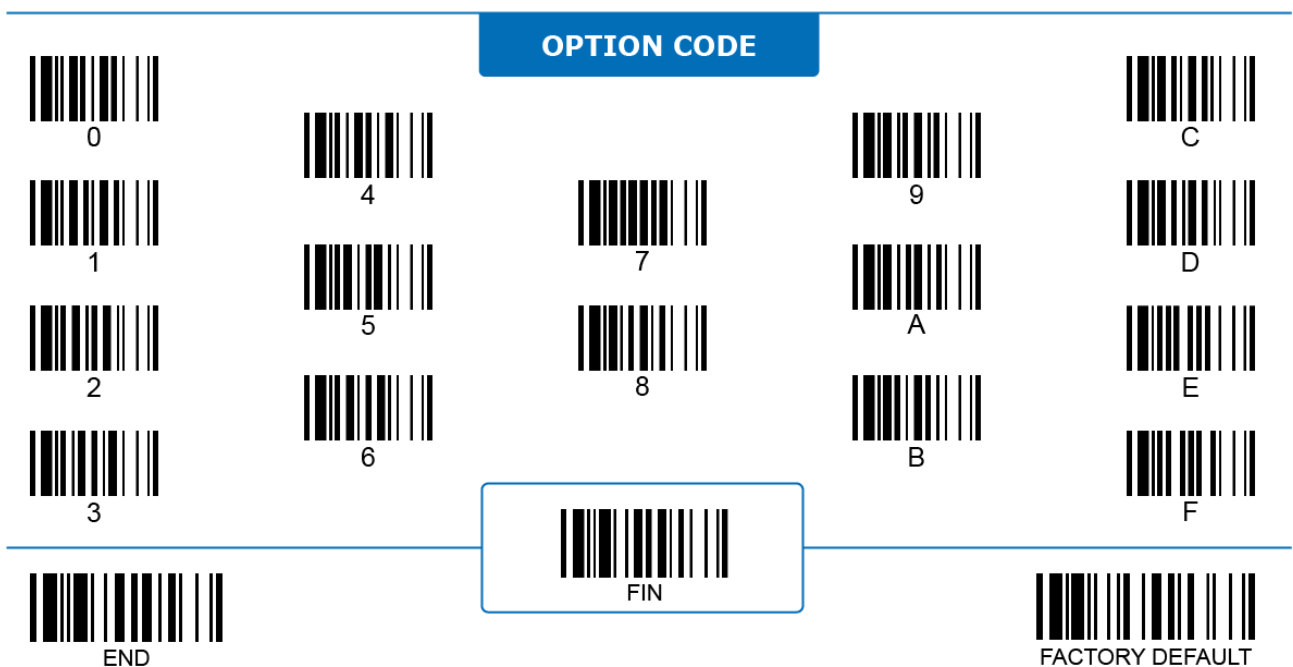

General Bluetooth Settings

BT Low Power Link Indicator



Program

Family Code	PP	Parameter Selection	Option Code
 Low Power Link Indicator	SS	LED indicator off	0
	SS	LED indicator lasts for 1 minute ◀	1
	SS	LED indicator stays on until the scanner powers off	2

BT Low Power Link Indicator configures the behavior of the link status LED Indicator when the scanner goes into **Low Power Standby Mode** due to its low battery power level.

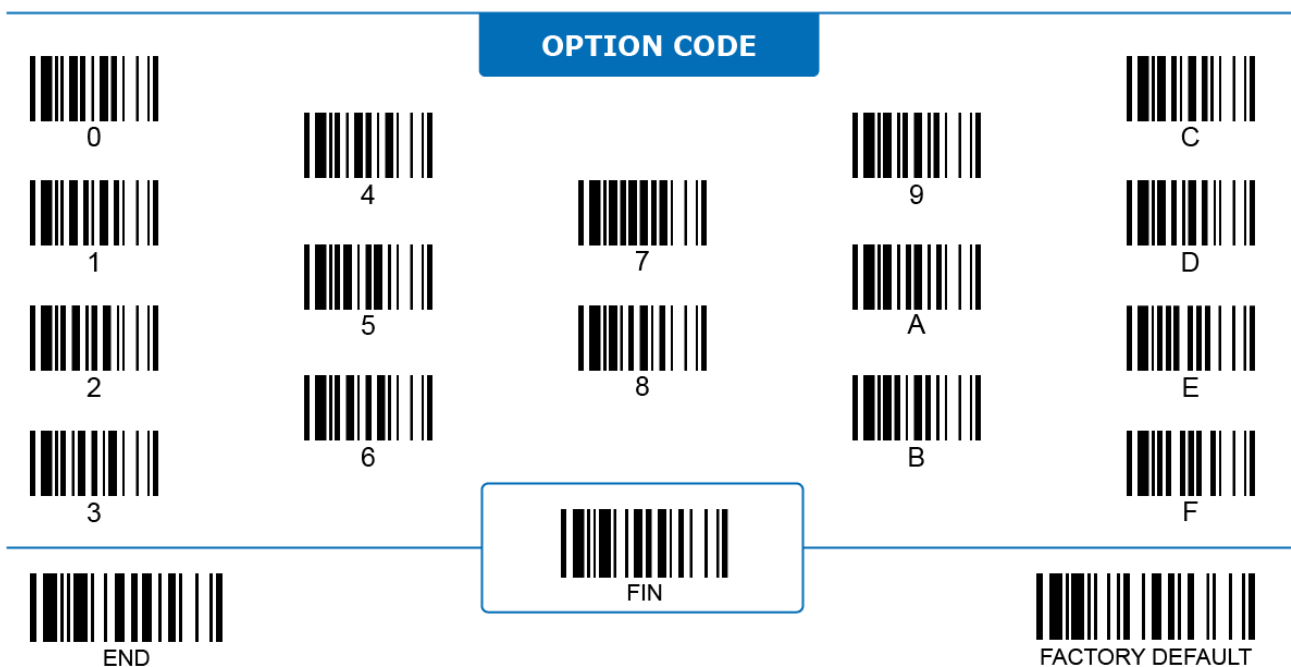

General Bluetooth Settings

BT Sniff Control



Program

Family Code	PP	Parameter Selection	Option Code
 BT Sniff Control	SS	Disable ◀	0
	SS	Enable	1

BT Sniff Control: When enabled, the Bluetooth scanner goes into Bluetooth Sniff Mode to lower power consumption.

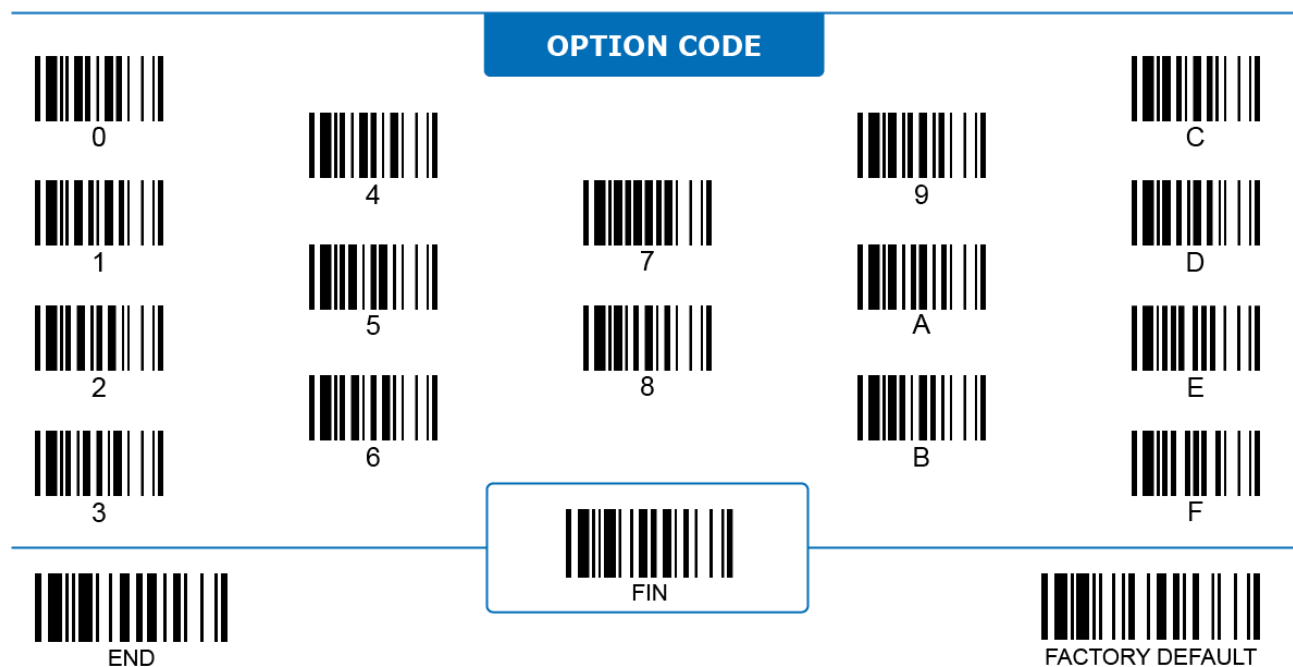

General Bluetooth Settings

BT Cradle PAIR Lock



Program

Family Code	PP	Parameter Selection	Option Code
 Cradle PAIR Lock	SS	Locked PAIR mode	0
	SS	Unlocked PAIR mode ◀	1

BT Cradle PAIR Lock configures the PAIR link between a scanner and the Smart Cradle it is pairing with.

- i. **Locked PAIR mode:** When selected, the cradle is locked with the scanner it is paired with and rejects any pairing request from other scanners. Uninstall your scanner to free the cradle before pairing it with another scanner.
- ii. **Unlocked PAIR mode:** When selected, any pairing request from a scanner is accepted by the cradle. It also cuts off the pairing with the previous scanner automatically.

OPTION CODE



0



4



7



9



C



1



5



8



A



D



2



6



B



E

3

FIN

F

END



FACTORY DEFAULT

Bluetooth Special Modes

Batch Scanning Link Control



Program

Family Code	PP	Parameter Selection	Option Code
 Link Control	SS	Disable	0
	SS	Enable ◀	1

- Batch Scanning Mode (Inventory Mode)** is one of the exclusive function modes of FuzzyScan Bluetooth scanners. Under this mode the scanner stores decoded data in its memory and transmit the data as a data batch, instead of transmitting the data immediately after each decode. Scan following command barcodes to enter or exit the batch scanning mode:





















Enter Batch Scanning



Exit Batch Scanning

- Batch Scanning Link Control:** When disabled, the scanner cuts off its radio link with the host device once it enters batch scanning mode. The scanner resumes its radio link when transmitting data batches or exiting batch scanning mode.

OPTION CODE

 0	 4	 7	 9	 C
 1	 5	 8	 A	 D
 2	 6	 B	 E	 F
 3	 FIN	 END	 FACTORY DEFAULT	

Bluetooth Special Modes

Batch Scanning Data Transmit



Program

Family Code	PP	Parameter Selection	Option Code
 Data Transmit	SS	On cradle or scan "Transmit Stored Data"	0
	SS	On cradle	1
	SS	Scan "Transmit Stored Data" ◀	2

Batch Scanning Data Transmit configures when the scanner transmits its stored data to the host device under batch scanning mode.

When **Scan "Transmit Stored Data"** is selected, scan the following barcode command to trigger data transmissions manually:



Transmit Stored Data

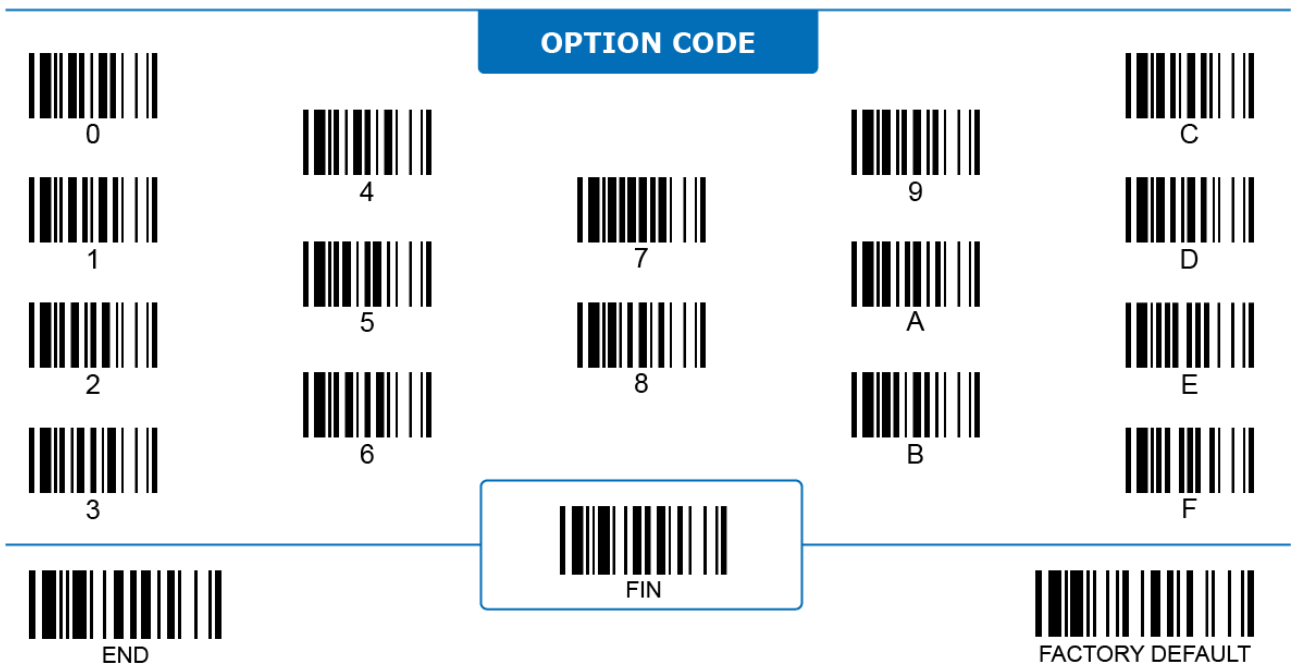

Bluetooth Special Modes

Batch Scanning Data Delete



Program

Family Code	PP	Parameter Selection	Option Code
 Data Delete	SS	Disable ◀	0
	SS	Enable	1



















Batch Scanning Data Delete: When enabled, the scanner deletes all decoded data stored in its memory immediately after transmitting. When disabled, the scanner keeps all its decoded data until “Clear All Stored Data” is scanned.

Scan the following barcode command to manually clean up all the stored data in the scanner’s memory:



Clear All Stored Data

OPTION CODE

 0	 4	 7	 9	 C
 1	 5	 8	 A	 D
 2	 6	 B	 E	 F
 3	<div style="border: 1px solid blue; padding: 5px; display: inline-block;">  FIN </div>			
 END			 FACTORY DEFAULT	

Bluetooth Special Modes
Batch Scanning ID Output



Program

Family Code	PP	Parameter Selection	Option Code
 ID Output	SS	Transmit scanned data only ◀	0
	SS	Transmit as <MAC address><Scanned data>	1
	SS	Transmit as <Scanner ID><Scanned data>	2
		Only available with RS232 serial, USB HID, and USB CDC interfaces under PAIR or PICO mode.	

Batch Scanning ID Output: When enabled, the scanner adds extra info in front of the scanned data to identify the scanner.

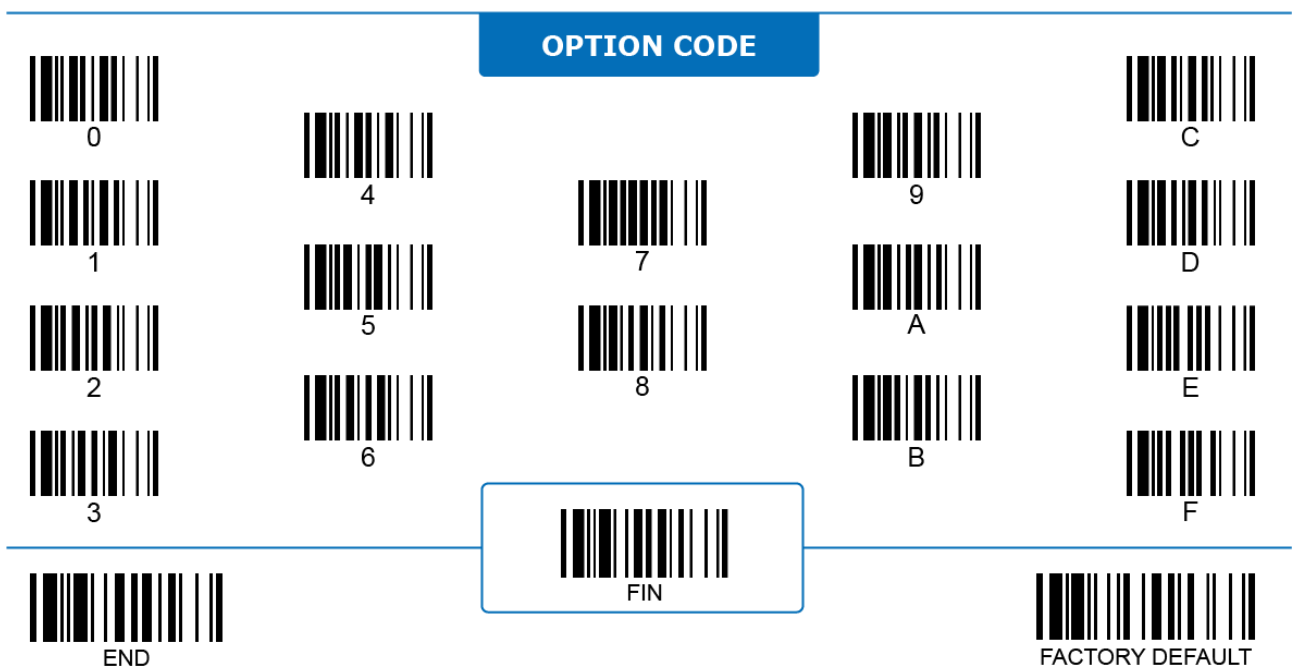

Batch Scanning Quantity Transmit



Program

Family Code	PP	Parameter Selection	Option Code
<p>Quantity Transmit</p>	SS	Transmit as many times as the quantity indicates ◀	0
	SS	<Quantity><Field delimiter><Scanned Data>	1
	SS	<Scanned Data><Field delimiter><Quantity>	2

Batch Scanning Quantity Transmit configures how quantity values are sent out to the host device in relation to the scanned data. To add a quantity value, scan the target barcode first then immediately enter a number between 1 and 9999 by scanning the corresponding quantity option code(s) as shown below. The entered quantity values are stored in memory and are later transmitted together with the barcode data in the selected format.

- **Transmit as many times as the quantity indicates:** When selected, the scanner transmits scanned data multiple times as the entered quantity number indicates, instead of transmitting the quantity number directly.



OPTION CODE

 0	 4	 7	 9	 C
 1	 5	 8	 A	 D
 2	 6	 B	 E	 F
 3	 FIN			 END
				 FACTORY DEFAULT

Bluetooth Special Modes

Batch Scanning Field Delimiter



Program

Family Code	PP	Parameter Selection	Option Code
 Field Delimiter	SS	None	0
	SS	“ , ” (Comma) ◀	1
	SS	SPACE	2
	SS	“ - ” (Dash)	3
	SS	“ . ” (Period)	4
	SS	User-defined	5, [00-7F]

Batch Scanning Field Delimiter configures the single character delimiter which separates scanned data and quantity value.

To enter the character, refer to the **HEX to ASCII Conversion Table** below:

L \ H	0	1	2	3	4	5	6	7
0	NUL	DLE	SPACE	0	@	P	`	p
1	SOH	DC1	!	1	A	Q	a	q
2	STX	DC2	*	2	B	R	b	r
3	ETX	DC3	#	3	C	S	c	s
4	EOT	DC4	\$	4	D	T	d	t
5	ENQ	NAK	%	5	E	U	e	u
6	ACK	SYN	&	6	F	V	f	v
7	BEL	ETB	'	7	G	W	g	w
8	BS	CAN	(8	H	X	h	x
9	HT	EM)	9	I	Y	i	y
A	LF	SUB	*	:	J	Z	j	z
B	VT	ESC	+	;	K	[k	{
C	FF	FS	.	<	L	\	l	
D	CR	GS	-	=	M]	m	}
E	SO	RS	.	>	N	^	n	~
F	SI	US	/	?	O	_	o	DEL

OPTION CODE



0



4



7



9



C



1



5



8



A



D



2



6



B



E



3

FIN

F

END



FIN

FACTORY DEFAULT

Validation Scanning Link Control



Program

Family Code	PP	Parameter Selection	Option Code
 Link Control	SS	Disable	0
	SS	Enable ◀	1

1. **Validation Scanning Mode** is one of the exclusive function modes of FuzzyScan Bluetooth scanners. Under this mode the scanner can check whether or not the scanned barcode matches the registered master data. Scan following command barcodes to enter or exit the validation scanning mode:



















Enter Validation Scanning





Exit Validation Scanning

2. **Validation Scanning Link Control:** When disabled, the scanner cuts off its radio link with the host device once it enters validation scanning mode. Radio link resumes later when the data transmission is activated or when the scanner exits validation scanning mode.

OPTION CODE

 0	 4	 7	 9	 C
 1	 5	 8	 A	 D
 2	 6	 FIN	 B	 E
 3			 F	



END

FACTORY DEFAULT

Validation Scanning Master Data



Program

Family Code	PP	Parameter Selection	Option Code
 Master Data	SS	Single master data ◀	0
	SS	Multiple master data	1

Validation Scanning Master Data configures if the validation scanning is based on a single master data or on multiple master data:

- i. **Single master data:** Scan the “Register Master Data” quick set command to start registering master data, and scan “Finish Registering” to end the registration. During the session the user can scan as many as barcodes, but only the last one can be stored and registered as the master data.
- ii. **Multiple master data:** Scan the “Register Master Data” quick set command to start registering master data, and scan “Finish Registering” to end the registration. All barcodes scanned during the session are stored and registered as the master data. FuzzyScan Bluetooth scanners can store up to 2K bytes of master data.



Register Master Data





















Finish Registering

When “Multiple master data” is selected, scan “Clear Master Data” to clear all registered master data in the scanner’s memory.



Clear Master Data

OPTION CODE

 0	 4	 7	 9	 C
 1	 5	 8	 A	 D
 2	 6	 FIN	 B	 E
 3			 F	
 END				 FACTORY DEFAULT

Bluetooth Special Modes

Validation Scanning Output Select



Program

Family Code	PP	Parameter Selection	Option Code
<p>Output Select</p>	SS	Disable data transmission ◀	0
	SS	Transmit valid data	1
	SS	Transmit invalid data	2
	SS	Transmit valid data or "NG"	3
	SS	Transmit invalid data or "OK"	4
	SS	Transmit "OK" or "NG"	5

Validation Scanning Output Select configures how the scanner reacts after comparing the scanned data and the master data stored in its memory:

- Disable data transmission:** When selected, the scanner does not transmit anything. You can still recognize the comparison results by the "OK" or "NG" beep the scanner emits
- Transmit valid data:** When selected, the scanner only transmits matched result, and abandons mismatched data.
- Transmit invalid data:** When selected, the scanner abandons matched data, and only transmits mismatched data.
- Transmit valid data or "NG":** When selected, the scanner transmits matched data or transmits a "NG" message if it is a mismatch.
- Transmit invalid data or "OK":** When selected, the scanner transmits an "OK" message if it is a match or the mismatched data otherwise.
- Transmit "OK" or "NG":** When selected, the scanner only transmits "OK" or "NG" message according to the match result, instead of transmitting the scanned data itself.

OPTION CODE

0

4

7

9

C

1

5

8

A

D

2

6

B

E

3

FIN

F

END

FIN

FACTORY DEFAULT

Bluetooth Special Modes
Companion FN2 Select



Program

Family Code	PP	Parameter Selection	Option Code
 FN2 Select	SS	Batch Scanning ◀	0
	SS	Validation Scanning	1
<p><i>Only available on PA, PF, and PL series companion scanners.</i></p>			

Companion FN2 Select configures which BT special mode the scanner switches to when its Function Key No.2 (FN2) is pressed.

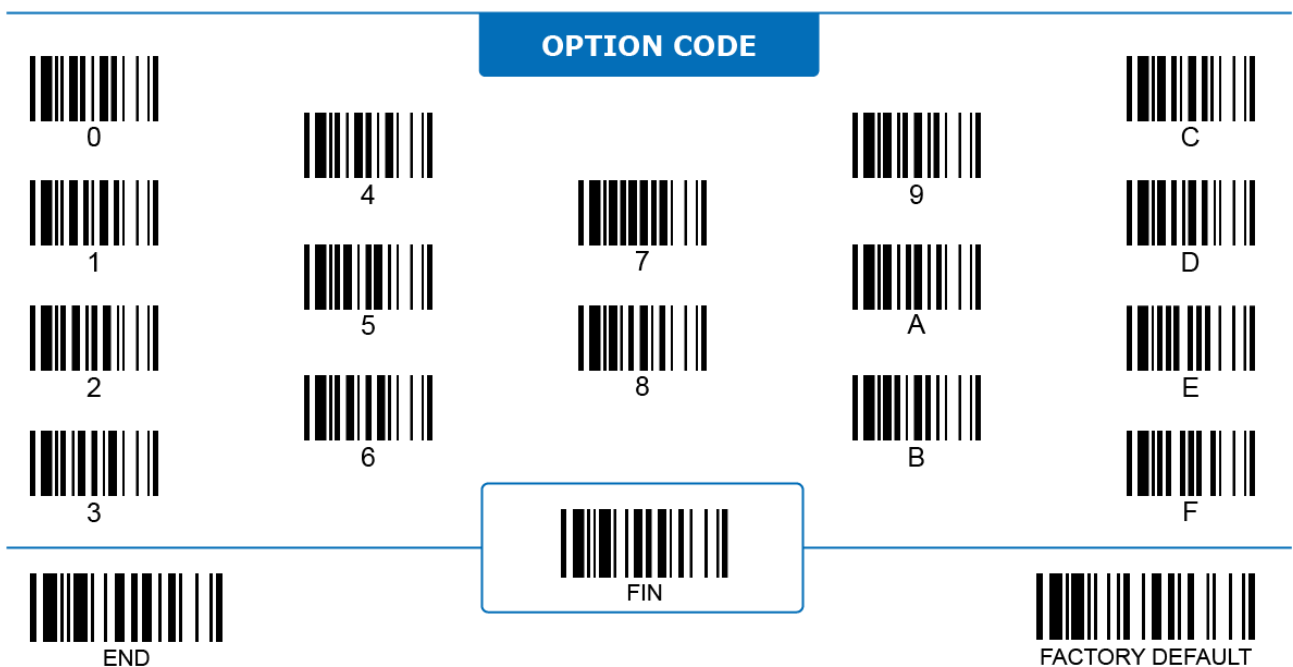

7 DATA MODIFICATIONS

This chapter presents different parameters for altering the data before the scanner transmits it out. Here, you will find the option to add extra characters, or to include an informative element. You can also find the parameters to control the powerful GS1 parsing tool here.

Global Settings

Preamble



Program

ALL

Family Code	PP	Parameter Selection	Option Code
<p>Preamble</p>	SS MS	None ◀ 1-15 characters Maximum of 15 characters; scan "FIN" to finish the setting.	FIN [00-7F], [FIN]

The table below shows the complete **Message String**:

(STX)	Preamble	Data Length	Prefix Code ID	Scanned Data	Suffix Code ID	Postamble	(ETX)	Record Suffix
(1char.)	1-15 characters	2-4 digits	1 or 3 characters	Variable length	1 or 3 characters	1-15 characters	(1 char)	1 character

STX and ETX are only transmitted under Serial Interfaces (RS232, USB COM).

To enter the character(s), refer to the **HEX to ASCII Conversion Table** below:

L \ H	0	1	2	3	4	5	6	7
0	NUL	DLE	SPACE	0	@	P	`	p
1	SOH	DC1	!	1	A	Q	a	q
2	STX	DC2	*	2	B	R	b	r
3	ETX	DC3	#	3	C	S	c	s
4	EOT	DC4	\$	4	D	T	d	t
5	ENQ	NAK	%	5	E	U	e	u
6	ACK	SYN	&	6	F	V	f	v
7	BEL	ETB	'	7	G	W	g	w
8	BS	CAN	(8	H	X	h	x
9	HT	EM)	9	I	Y	i	y
A	LF	SUB	*	:	J	Z	j	z
B	VT	ESC	+	;	K	[k	{
C	FF	FS	,	<	L	\	l	
D	CR	GS	-	=	M]	m	}
E	SO	RS	.	>	N	^	n	~
F	SI	US	/	?	O	_	o	DEL

OPTION CODE

0

4

7

9

C

1

5

8

A

D

2

6

B

E

3

FIN

F

END

FIN

FACTORY DEFAULT

Global Settings

Postamble



Program

ALL

Family Code	PP	Parameter Selection	Option Code
 Postamble	SS None ◀ MS 1-15 characters	Maximum of 15 characters; scan "FIN" to finish the setting.	FIN [00-7F], [FIN]

The table below shows the complete **Message String**:

(STX)	Preamble	Data Length	Prefix Code ID	Scanned Data	Suffix Code ID	Postamble	(ETX)	Record Suffix
(1 char.)	1-15 characters	2-4 digits	1 or 3 characters	Variable length	1 or 3 characters	1-15 characters	(1 char)	1 character

STX and ETX are only transmitted under Serial Interfaces (RS232, USB COM).

To enter the character(s), refer to the **HEX to ASCII Conversion Table** below:

L \ H	0	1	2	3	4	5	6	7
0	NUL	DLE	SPACE	0	@	P	`	p
1	SOH	DC1	!	1	A	Q	a	q
2	STX	DC2	*	2	B	R	b	r
3	ETX	DC3	#	3	C	S	c	s
4	EOT	DC4	\$	4	D	T	d	t
5	ENQ	NAK	%	5	E	U	e	u
6	ACK	SYN	&	6	F	V	f	v
7	BEL	ETB	'	7	G	W	g	w
8	BS	CAN	(8	H	X	h	x
9	HT	EM)	9	I	Y	i	y
A	LF	SUB	*	:	J	Z	j	z
B	VT	ESC	+	;	K	[k	{
C	FF	FS	,	<	L	\	l	
D	CR	GS	-	=	M]	m	}
E	SO	RS	.	>	N	^	n	~
F	SI	US	/	?	O	_	o	DEL

OPTION CODE



0



4



7



9



C



1



5



8



A



D



2



6



B



E



3

FIN

F

END

FIN

FACTORY DEFAULT

Global Settings

Record Suffix (Keyboard)



Program

ALL

Family Code	PP	Parameter Selection	Option Code
 Record Suffix (KB)	SS	None	0
	SS	RETURN ◀	1
	SS	TAB	2
	SS	SPACE	3
	DS	User-defined character (1 character)	5, (00-7F)

The table below shows the complete **HID Keyboard Interface Message String**:

Preamble	Data Length	Prefix Code ID	Scanned Data	Suffix Code ID	Postamble	Record Suffix
1-15 characters	2-4 digits	1 or 3 characters	Variable length	1 or 3 characters	1-15 characters	1 character

To enter the character, refer to the **HEX to ASCII Conversion Table** below:

L \ H	0	1	2	3	4	5	6	7
0	NUL	DLE	SPACE	0	@	P	`	p
1	SOH	DC1	!	1	A	Q	a	q
2	STX	DC2	*	2	B	R	b	r
3	ETX	DC3	#	3	C	S	c	s
4	EOT	DC4	\$	4	D	T	d	t
5	ENQ	NAK	%	5	E	U	e	u
6	ACK	SYN	&	6	F	V	f	v
7	BEL	ETB	'	7	G	W	g	w
8	BS	CAN	(8	H	X	h	x
9	HT	EM)	9	I	Y	i	y
A	LF	SUB	*	:	J	Z	j	z
B	VT	ESC	+	;	K	[k	{
C	FF	FS	,	<	L	\	l	
D	CR	GS	-	=	M]	m	}
E	SO	RS	.	>	N	^	n	~
F	SI	US	/	?	O	_	o	DEL

OPTION CODE

0

4

9

C

1

5

7

D

2

6

8

A

E

3

B

F

END

FIN

FACTORY DEFAULT

Global Settings

Record Suffix (Serial)



Program

ALL

Family Code	PP	Parameter Selection	Option Code
 Record Suffix (Serial)	SS	None	0
	SS	CR (0Dh) ◀	1
	SS	LF (0Ah)	2
	SS	CRLF (0Dh 0Ah)	3
	SS	TAB (09h)	4
	SS	SPACE (20h)	5
	MS	User-defined character (1 character)	6, (00-7F)

The table below shows the complete **Serial Interface Message String** (RS232, USB COM) :

STX	Preamble	Data Length	Prefix Code ID	Scanned Data	Suffix Code ID	Postamble	ETX	Record Suffix
1char.	1-15 characters	2-4 digits	1 or 3 characters	Variable length	1 or 3 characters	1-15 characters	1 char	1 character

OPTION CODE

0

4

7

9

C

1

5

A

D

2

6

B

E

3

FIN

F

END

FIN

FACTORY DEFAULT

Global Settings

Dollar Sign Convert

ALL



Program

Family Code	PP	Parameter Selection	Option Code
 Dollar Sign Convert	SS	Output as "\$" ◀	0
	SS	Output as "¥"	1
	SS	Output as "€"	2
	SS	Output as "£"	3
	SS	Output as "¢"	4

Dollar Sign Convert configures what the scanner actually transmits when it decodes a barcode containing the dollar sign.

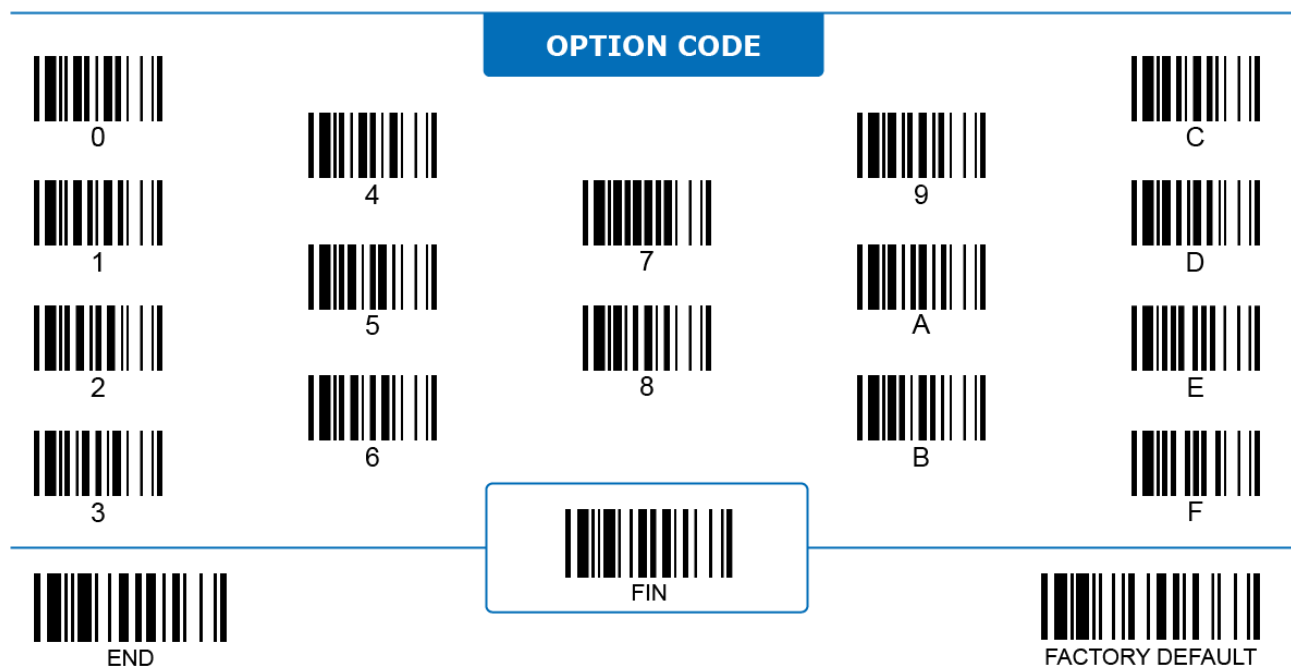

Global Settings
FNC1 Transmit



Program

ALL

Family Code	PP	Parameter Selection	Option Code
 FNC1 Transmit	SS	Disable	0
	SS	Enable ◀	1

FNC1 Transmit: When enabled, the scanner transmits FNC1 (Function 1 Character) to the host if FNC1 is included in the decoded data.

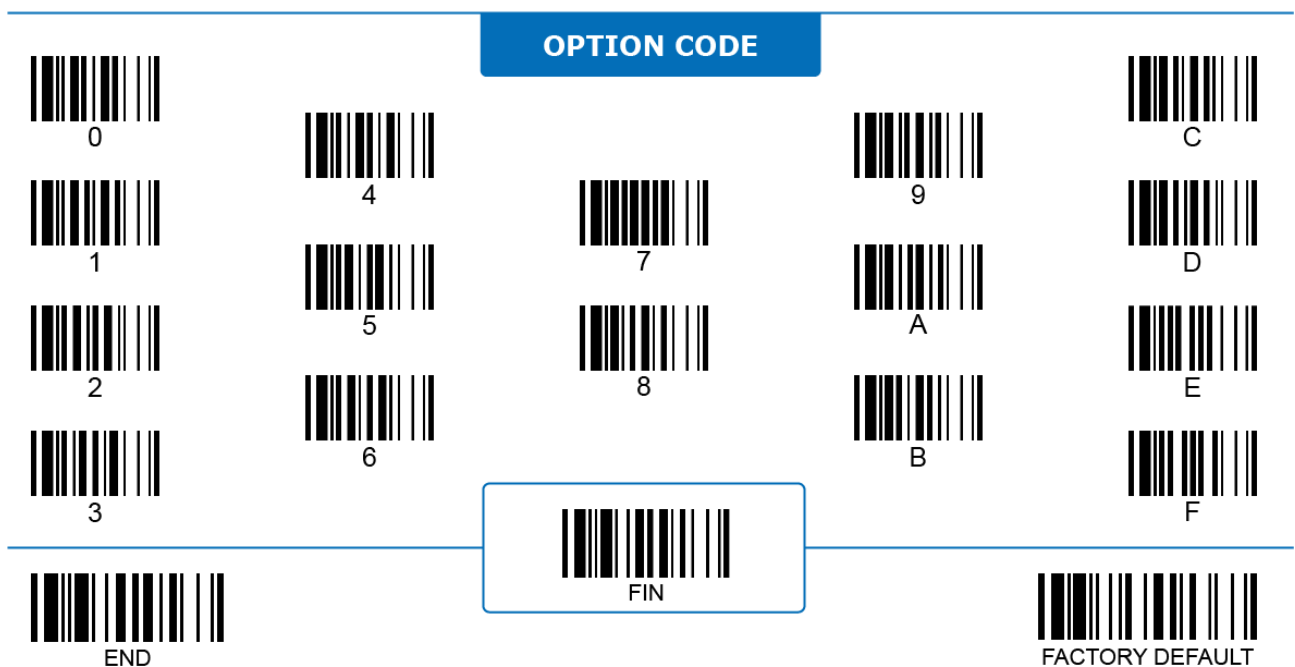

Global Settings

Data Length Transmit



Program

ALL

Family Code	PP	Parameter Selection	Option Code
 Data Length Transmit	SS	Disable ◀	0
	SS	Enable	1

Data Length Transmit: When enabled, the scanner transmits data length information in a 2- or 4-digit format. If the data length is shorter than 100 characters, length information is sent as a 2-digit number.

The table below shows the complete **Message String**:

(STX)	Preamble	Data Length	Prefix Code ID	Scanned Data	Suffix Code ID	Postamble	(ETX)	Record Suffix
(1char.)	1-15 characters	2-4 digits	1 or 3 characters	Variable length	1 or 3 characters	1-15 characters	(1 char)	1 character

STX and ETX are only transmitted under Serial Interfaces (RS232, USB COM).

OPTION CODE



Global Settings

Code ID Transmit



Program

ALL

Family Code	PP	Parameter Selection	Option Code
 Code ID Transmit	SS	Disable ◀	0
	SS	Transmit Cino ID as prefix	1
	SS	Transmit Cino ID as suffix	2
	SS	Transmit Cino ID as prefix and suffix	3
	SS	Transmit AIM ID as prefix	4
	SS	Transmit AIM ID as suffix	5
	SS	Transmit AIM ID as prefix and suffix	6

Code ID Transmit: When enabled, the scanner transmits code ID together with decoded data to identify the type of scanned barcode. Code ID can be transmitted either as a prefix, a suffix, or both. Refer to **Appendix – Code ID Table** for a complete list of Cino code ID and AIM code ID.

The table below shows the complete Message String:

(STX)	Preamble	(Data Length)	Prefix Code ID	Scanned Data	Suffix Code ID	Postamble	(ETX)	Record Suffix
(1char.)	1-15 characters	(2-4 digits)	1 or 3 characters	Variable length	1 or 3 characters	1-15 characters	(1 char)	1 character

STX and ETX are only transmitted under Serial Interfaces (RS232, USB COM).

OPTION CODE

0

4

7

9

C

1

5

8

A

D

2

6

B

E

F

3

FIN

END

FACTORY DEFAULT

Global Settings
ECI ID Transmit



Program

ALL

Family Code	PP	Parameter Selection	Option Code
 ECI ID Transmit	SS	Disable ◀	0
	SS	Enable	1

ECI ID Transmit: When enabled, the scanner transmits the ECI (Extended Channel Interpretation) ID embedded in the barcode.

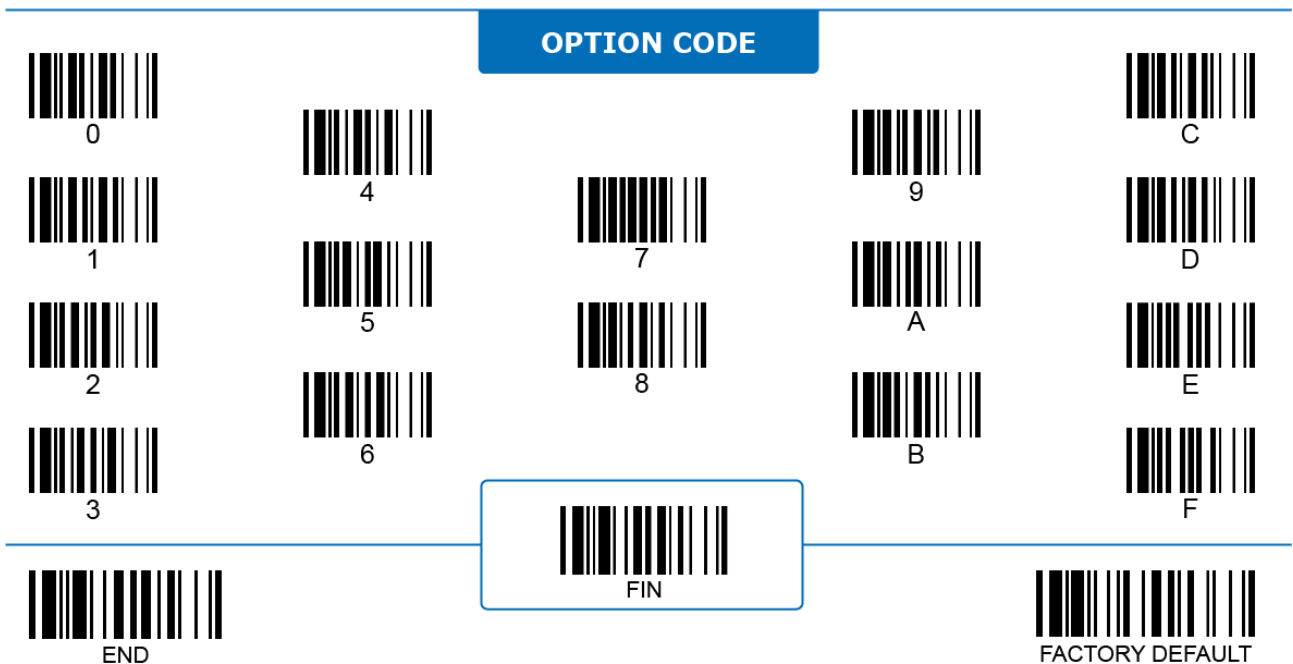

GS1 Settings

GS1 Special Function



Program

ALL

Family Code	PP	Parameter Selection	Option Code
 GS1 Special Function	SS	Disable ◀	0
	SS	Enable	1

GS1 Special Function: When enabled, the scanner analyzes and transmits GS1 codes according to the settings of GS1-related parameters and GS1 formatter. When disabled, the scanner directly transmits these codes as normal barcodes. The **GS1 formatter** is provided by the FuzzyScan PowerTool 3 utility software.

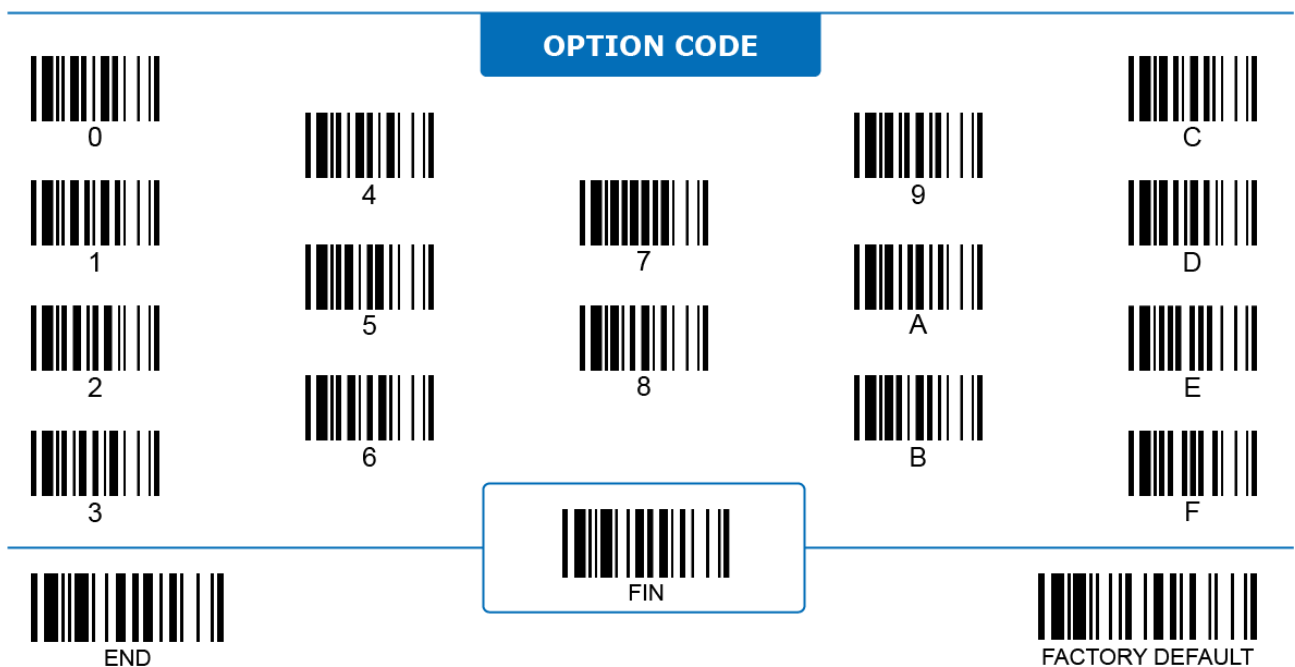

GS1 Settings

GS1 1st FNC1 Transmit



Program

ALL

Family Code	PP	Parameter Selection	Option Code
 GS1 1st FNC1 Transmit	SS	Disable ◀	2
	SS	Enable	3

GS1 1st FNC1 Transmit: When enabled, the scanner converts the invisible FNC1 character in GS1 codes into a visible text string “]C1” and transmits it to the host. With this option, if there is more than one FNC1 character in the GS1 code, only the first FNC1 is converted.

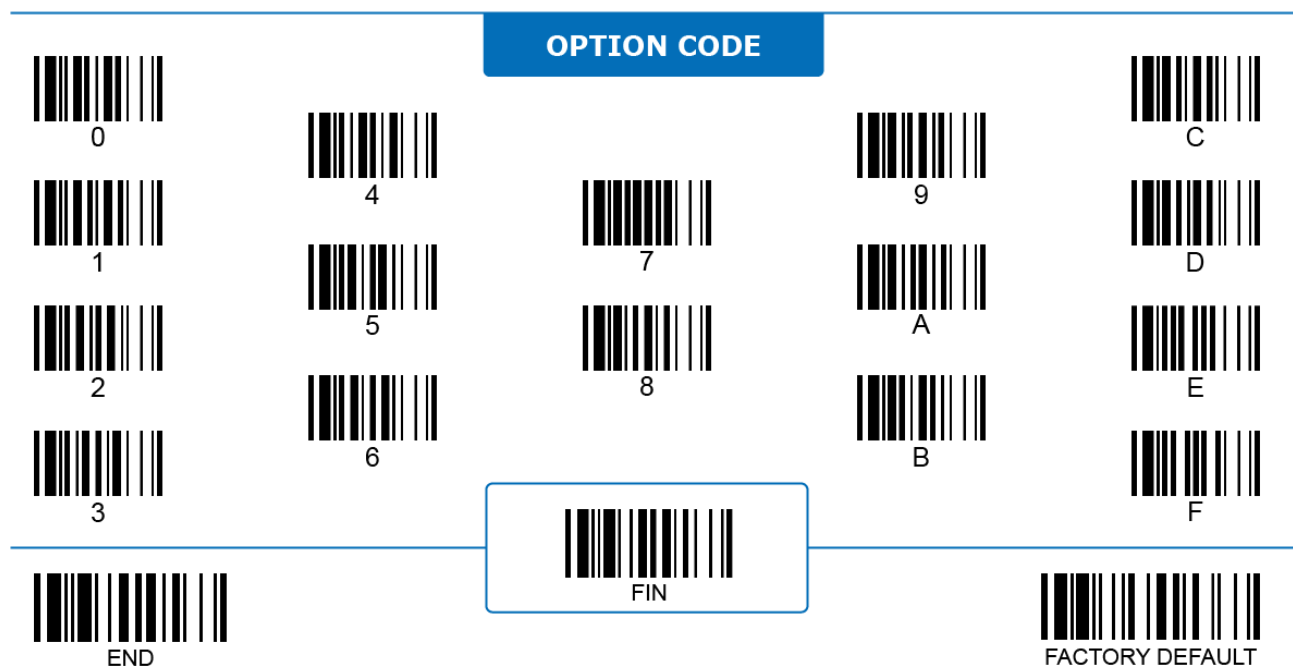

GS1 Settings

GS1 Noninitial FNC1 Transmit



Program

ALL

Family Code	PP	Parameter Selection	Option Code
 Noninitial FNC1 Transmit	SS	None ◀	0
	SS	<GS> (1Dh)	1
	MS	User-defined character (1~2 characters)	2, [00-7F],[FIN]

GS1 Noninitial FNC1 Transmit: In GS1 codes, noninitial FNC1 (FNC1 not located at the start of the barcode) is used to mark the end position of a data field with a variable length. When **FNC1 Transmit** is enabled and the GS1 contains a data field(s) with a variable data length, the scanner converts and transmits the invisible FNC1 character(s) accordingly.

- None:** The scanner divides the variable length data field according to the noninitial FNC1, but does not transmit the FNC1.
- <GS>:** The scanner converts the noninitial FNC1 to <GS> (value 1Dh) in serial interface, or its corresponding character in HID keyboard interface.
- User-defined:** The scanner converts the noninitial FNC1 to the user-defined value in a serial interface, or its corresponding character(s) in a HID keyboard interface.

To enter the character(s), refer to the **HEX to ASCII Conversion Table** below:

L \ H	0	1	2	3	4	5	6	7
0	NUL	DLE	SPACE	0	@	P	`	p
1	SOH	DC1	!	1	A	Q	a	q
2	STX	DC2	"	2	B	R	b	r
3	ETX	DC3	#	3	C	S	c	s
4	EOT	DC4	\$	4	D	T	d	t
5	ENQ	NAK	%	5	E	U	e	u
6	ACK	SYN	&	6	F	V	f	v
7	BEL	ETB	'	7	G	W	g	w
8	BS	CAN	(8	H	X	h	x
9	HT	EM)	9	I	Y	i	y
A	LF	SUB	*	:	J	Z	j	z
B	VT	ESC	+	;	K	[k	{
C	FF	FS	,	<	L	\	l	
D	CR	GS	-	=	M]	m	}
E	SO	RS	.	>	N	^	n	~
F	SI	US	/	?	O	_	o	DEL

OPTION CODE



0



4



7



9



C



1



5



8



A



D



2



6



B



E



3



FIN



F



END



FACTORY DEFAULT

GS1 Settings

GS1 AI Transmit

ALL



Program

Family Code	PP	Parameter Selection	Option Code
 GS1 AI Transmit	SS	Do not transmit AI ◀	4
	SS	Transmit AI	5
	SS	Transmit AI enclosed with parentheses "(" and ")"	6

GS1 AI Transmit configures how the scanner processes the **Application Identifier (AI)** embedded in the GS1 code. When disabled, the scanner organizes decoded data before transmitting according to the embedded AIs, but does not directly transmit the AI characters themselves.

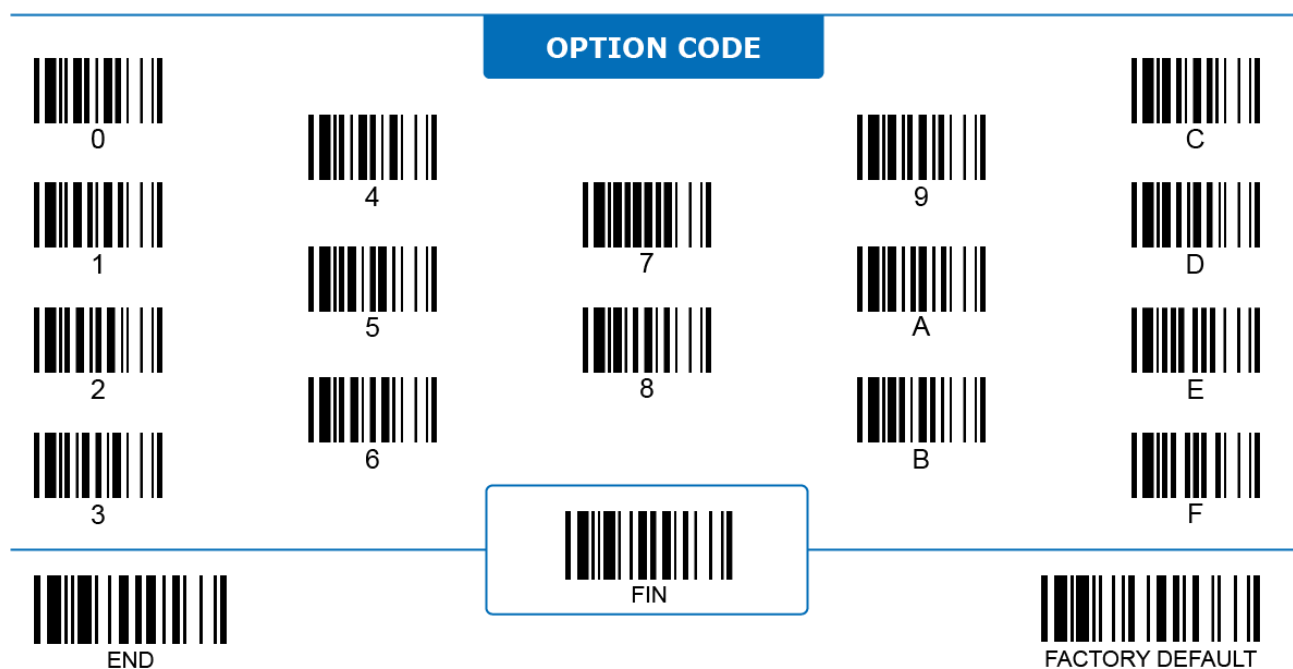

GS1 Settings

GS1 Failure Rule



Program

ALL

Family Code	PP	Parameter Selection	Option Code
 GS1 Failure Rule	SS	Abandon data ◀	0
	SS	Transmit unparsed data	1

GS1 Failure Rule configures how the scanner processes the decoded data when the GS1 parsing rule fails. GS1 Parsing fails under the following conditions:

- i. The scanned data is labeled as GS1 but (part of) its format does not follow GS1 standard.
- ii. The scanned data contains rarely used Application Identifier (AI) not supported by FuzzyScan products.

OPTION CODE



GS1 Settings

GS1 Prefix/Suffix Output



Program

ALL

Family Code	PP	Parameter Selection	Option Code
 GS1 Prefix/ Suffix Output	SS	Output prefix/suffix of all AI fields ◀	0
	SS	Output prefix/suffix of existing AI fields only	1

GS1 Prefix/Suffix Output configures how the scanner processes the user-defined prefix/suffix set by **GS1 formatter** in the PowerTool 3 utility software:

- i. **Output prefix/suffix of all AI fields:** If you have set a prefix/suffix for a specific Application Identifier (AI) field but the AI doesn't exist in the GS1 code you scan, the scanner outputs the prefix/suffix without its corresponding AI and scanned data.
- ii. **Output prefix/suffix of existing AI fields only:** If you have set a prefix/suffix for a specific AI field but the AI doesn't exist in the GS1 code you scan, the scanner skips the AI and its corresponding prefix/suffix.

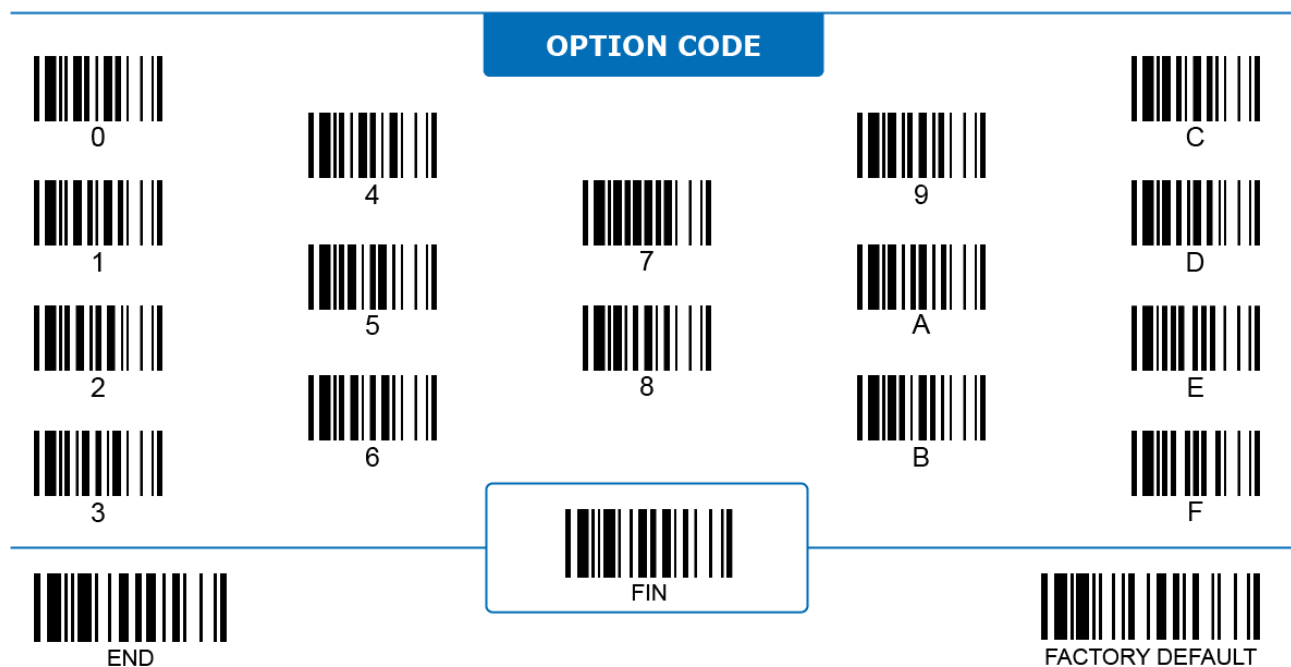

GS1 Settings

GS1 Format Mismatch Rule



Program

ALL

Family Code	PP	Parameter Selection	Option Code
 GS1 Format Mismatch Rule	SS	Abandon data ◀	2
	SS	Output original data	3

GS1 Format Mismatch Rule configures how the scanner processes the scanned GS1 data if all the Application Identifier (AI) fields in the barcodes mismatch with the AI fields you have defined with the **GS1 formatter** in PowerTool 3 utility software:

- i. **Abandon data:** Abandon the complete GS1 code and transmit nothing.
- ii. **Output original data:** Keep the data and transmit it as a normal barcode without GS1 parsing.

GS1 Format Mismatch Rule is only effective when **GS1 Prefix/Suffix Output** is set to "Output prefix/suffix of all AI fields".

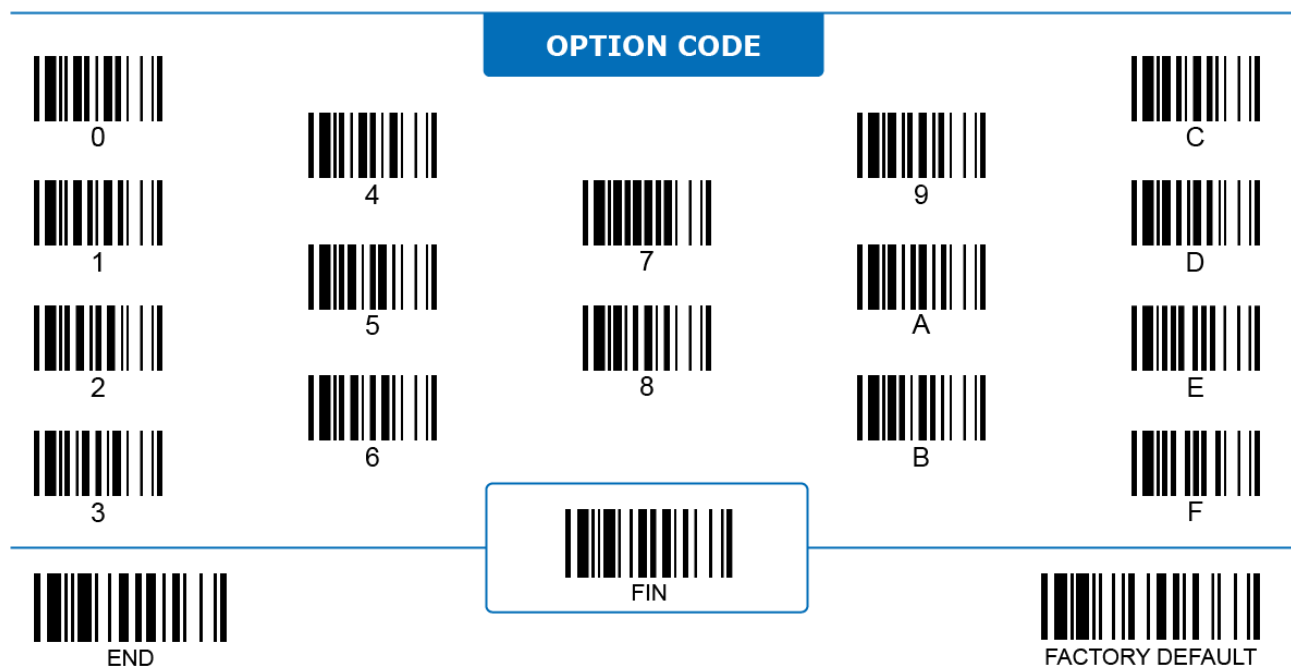

GS1 Settings

GS1 Date Field 'DD=00' Transmit



Program

ALL

Family Code	PP	Parameter Selection	Option Code
 GS1 'DD=00' Transmit	SS	Disable	7
	SS	Transmit 'DD=00' ◀	8

GS1 Date Field "DD=00" Transmit: When enabled, the scanner transmits "00" directly if the data string contains date-type field and the last two digits of YYMMDD equals to "00". When disabled, the scanner omits "00" and sends out YYMM instead.

OPTION CODE



0



1



2



3



4



5



6



7



8



9



A



B



C



D



E



F



FIN



END



FACTORY DEFAULT

GS1 Settings

GS1 Decimal Point Insert



Program

ALL

Family Code	PP	Parameter Selection	Option Code
 GS1 Decimal Point Insert	SS SS	Disable ◀ Enable	9 A

GS1 Decimal Point Insert: When enabled, the scanner inserts a decimal point into each number-type data field if the decimal point position is implied in its Application Identifier (AI).

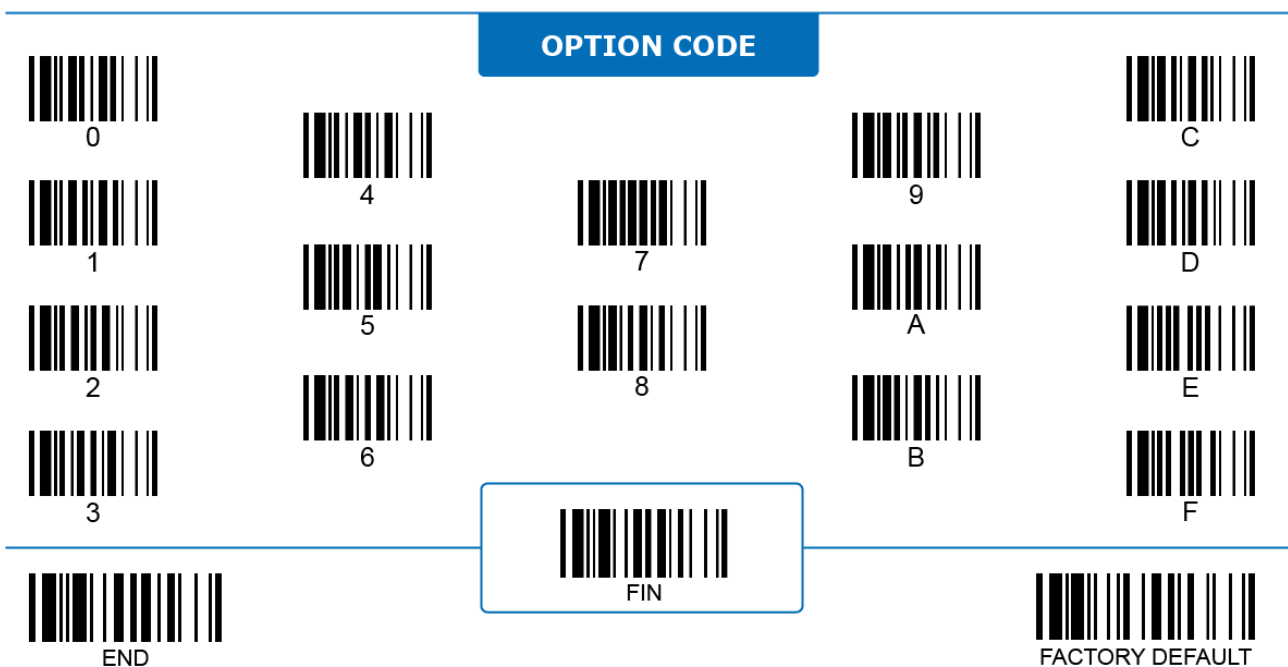

GS1 Settings

GS1 Element String Separator



Program

ALL

Family Code	PP	Parameter Selection	Option Code
 <p>Element String Separator</p>	SS MS	None ◀ User-defined character (1~2 characters)	FIN [00-7F], [FIN]

GS1 Element String Separator: When enabled, the user-defined character appears at the end of each element string except the last one.

The FNC1 character is enclosed within the element string (positioned before the separator) if **GS1 Noninitial FNC1 Transmission Selection** is enabled.

To enter the character(s), refer to the **HEX to ASCII Conversion Table** below:

L \ H	0	1	2	3	4	5	6	7
0	NUL	DLE	SPACE	0	@	P	`	p
1	SOH	DC1	!	1	A	Q	a	q
2	STX	DC2	*	2	B	R	b	r
3	ETX	DC3	#	3	C	S	c	s
4	EOT	DC4	\$	4	D	T	d	t
5	ENQ	NAK	%	5	E	U	e	u
6	ACK	SYN	&	6	F	V	f	v
7	BEL	ETB	'	7	G	W	g	w
8	BS	CAN	(8	H	X	h	x
9	HT	EM)	9	I	Y	i	y
A	LF	SUB	*	:	J	Z	j	z
B	VT	ESC	+	;	K	[k	{
C	FF	FS	,	<	L	\	l	
D	CR	GS	-	=	M]	m	}
E	SO	RS	.	>	N	^	n	~
F	SI	US	/	?	O	_	o	DEL

OPTION CODE



0



4



7



9



C



1



5



8



A



D



2



6



B



E



3

FIN

F

END

FIN

FACTORY DEFAULT

GS1 Settings

GS1 Data Separator



Program

ALL

Family Code	PP	Parameter Selection	Option Code
 Data Separator	SS MS	None ◀ User-defined character (1~2 characters)	FIN [00-7F], [FIN]

GS1 Data Separator: When enabled, the user-defined character appears at the second dividing position between data sections within an element string if there are three or more data sections. For example, data field ITIP (AI 8006) has a format of N4+N14+N2+N2. If you set the comma (2Ch) as the GS1 Data Separator and enables AI transmission, the scanner actually transmits out (800)N14,N2,N2 for the specific element string.

To enter the character(s), refer to the **HEX to ASCII Conversion Table** below:

L \ H	0	1	2	3	4	5	6	7
0	NUL	DLE	SPACE	0	@	P	`	p
1	SOH	DC1	!	1	A	Q	a	q
2	STX	DC2	*	2	B	R	b	r
3	ETX	DC3	#	3	C	S	c	s
4	EOT	DC4	\$	4	D	T	d	t
5	ENQ	NAK	%	5	E	U	e	u
6	ACK	SYN	&	6	F	V	f	v
7	BEL	ETB	'	7	G	W	g	w
8	BS	CAN	(8	H	X	h	x
9	HT	EM)	9	I	Y	i	y
A	LF	SUB	*	:	J	Z	j	z
B	VT	ESC	+	;	K	[k	{
C	FF	FS	,	<	L	\	l	
D	CR	GS	-	=	M]	m	}
E	SO	RS	.	>	N	^	n	~
F	SI	US	/	?	O	_	o	DEL

OPTION CODE



APPENDIX

The Appendix contains additional information that is essential to the programming of your FuzzyScan barcode scanners. In it, you will find useful tables pertaining to 1D code ID, 2D code ID, function key character tables, ASCII/HEX conversion, and code pages. This section also includes quick set commands, systems commands, as well as option codes.

Code ID Table

Code ID for 1D Barcodes

1D Code ID Table					
Code Family	Primary Format	Cino ID		AIM ID	
		Hex value	Char.	Code Char.	Modified Char.
UPC	UPC A	2	A	E	0
	UPC A with 2 suppl.	32			1
	UPC A with 5 suppl.	42			2
	UPC E	3	E		0
	UPC E with 2 suppl.	33			1
	UPC E with 5 suppl.	43			2
	AIM ID Example: UPC A barcode "012345678950" with 2-digit supplement "12" is sent as "JE0012345678950JE112"				
Code 128	Code 128	01	B	C	m
	GS1 128	31	C		1
Codabar	Codabar	06	D	F	m
Code 25	Industrial 25	08	I	S	0
	Matrix 25	38	K	X	0
	Interleaved 25	48	J	I	m
	China Postal Code	58	L	X	0
	German Postal Code	68	M	I	m
IATA	IATA	15	O	R	m
UCC Coupon	UCC Coupon Code	Z			
	AIM ID Examples: UPC A "512345678900" plus GS1 128 "81010123451297" is sent as "JE0512345678900JC181010123451297" EAN 13 "9923456789019" plus GS1 128 "81010123451297" is sent as "JE09923456789019JC181010123451297"				
EAN/JAN	EAN/JAN 8	05	N	E	4
	EAN/JAN 8 with 2 suppl.	35			1
	EAN/JAN 8 with 5 suppl.	45			2
	EAN/JAN 13	04	F		0
	EAN/JAN 13 with 2 suppl.	34			1
	EAN/JAN 13 with 5 suppl.	44			2
	AIM ID Example: EAN/JAN-8 "49123562" with 5-digit supplement "12345" is sent as "JE449123562JE212345"				
Code 93	Code 93	09	H	G	m
Code 11	Code 11	10	P	H	m
MSI	MSI	11	R	M	m
UK/Plessey	UK/Plessey	12	S	P	0
Telepen	Telepen	13	T	B	m
GS1 DataBar	GS1 Databar	14	X	e	m
	GS1 DataBar Limited	22			
	GS1 DataBar Expanded	23			
Composite	Composite Code	24			
Code 39	Code 39	07	G	A	m
	Code 39 Trioptic	47	W	X	0
	Code 32	37	G	A	0
PDF417	PDF417	17	V	L	m
	Micro PDF417	25			
Korea Post	Korea Post Code	21	a	X	0

Each AIM Code Identifier contains a three-character string **Jcm** where:
J = Flag Character; **c** = Code Character; **m** = Modifier Character

Code ID for 2D Barcodes

2D Code ID Table					
Code Family	Primary Format	Cino ID		AIM ID	
		Hex Value	Char.	Code Char.	Modified Char.
QR Code	QR Code	A0	b	Q	m
	Micro QR Code				
	GS1 QR Code	A6	s		3
Data Matrix	Data Matrix	A1	c	d	M
	GS1 Data Matrix	A5	r		2
MaxiCode	MaxiCode	A2	d	U	m
Aztec Code	Aztec Code	A3	e	z	m
Australian Post	Australian Post	B0	g	X	0
British Post	British Post	B1	h		0
Intelligent Mail	Intelligent Mail	B3	j		0
Japanese Post	Japanese Post	B4	k		0
KIX Post	KIX Post	B5	l		0
Posi LAPA Code	Posi LAPA Code	C1	q		0
Planet Code	Planet Code	B6	m		0
Postnet	Postnet	B8	o		0

Each AIM Code Identifier contains a three-character string]cm where:
] = Flag Character; c = Code Character; m = Modifier Character

ASCII Input Shortcut

To configure user-definable parameters, scan the desired ASCII value in **HEX** form. See the "**HEX/ASCII Table**" for details.

Example:

To have data output lead with a Dollar Sign, set the "Preamble" to "\$". The configuration procedure is listed below.

- Scan system command – **PROGRAM** to enter programming mode.
- Scan family code – **PREAMBLE**.
- See the **Hex/ASCII Table**. HEX value of "\$" is **24**.
- Scan option code – **2**.
- Scan option code – **4**.
- Scan system command – **FIN (Finish)** to terminate Preamble setting.

Scan system command – **End** to exit programming mode.

HEX/ASCII Reference Table

H \ L	0	1	2	3	4	5	6	7
0	NUL	DLE	SPACE	0	@	P	`	p
1	SOH	DC1	!	1	A	Q	a	q
2	STX	DC2	"	2	B	R	b	r
3	ETX	DC3	#	3	C	S	c	s
4	EOT	DC4	\$	4	D	T	d	t
5	ENQ	NAK	%	5	E	U	e	u
6	ACK	SYN	&	6	F	V	f	v
7	BEL	ETB	'	7	G	W	g	w
8	BS	CAN	(8	H	X	h	x
9	HT	EM)	9	I	Y	i	y
A	LF	SUB	*	:	J	Z	j	z
B	VT	ESC	+	;	K	[k	{
C	FF	FS	,	<	L	\	l	
D	CR	GS	-	=	M]	m	}
E	SO	RS	.	>	N	^	n	~
F	SI	US	/	?	O	_	o	DEL

Example: ASCII "A" → HEX "41"; ASCII "a" → "61"

■ : High Byte of HEX Value

□ : Low Byte of HEX Value

Function Key Output Table

	ASCII	ANSI	Function Key Character (Default)
00	00H	NUL	RESERVED
01	01H	SOH	CTRL (Left)
02	02H	STX	ALT (Left)
03	03H	ETX	SHIFT
04	04H	EOT	CAPS LOCK
05	05H	ENQ	NUM LOCK
06	06H	ACK	ESC
07	07H	BEL	F1
08	08H	BS	BACK SPACE
09	09H	HT	TAB
10	0AH	LF	F2
11	0BH	VT	F3
12	0CH	FF	F4
13	0DH	CR	ENTER (CR)
14	0EH	SO	F5
15	0FH	SI	F6
16	10H	DLE	F7
17	11H	DC1	F8
18	12H	DC2	F9
19	13H	DC3	F10
20	14H	DC4	F11
21	15H	NAK	F12
22	16H	SYN	INS (Insert) (Edit)
23	17H	ETB	DEL (Delete) (Edit)
24	18H	CAN	HOME (Edit)
25	19H	EM	END (Edit)
26	1AH	SUB	PAGE UP (Edit)
27	1BH	ESC	PAGE DOWN (Edit)
28	1CH	FS	UP (Edit)
29	1DH	GS	DOWN (Edit)
30	1EH	RS	LEFT (Edit)
31	1FH	US	RIGHT (Edit)

To emulate the keystroke to send out special function characters under HID keyboard interface, you must configure actual content using the reserved ASCII 0 – 31 characters. You can change the output character of each key with **User-defined Function Key**, or by editing the Function Key Output Table via the **PowerTool 3** software utility. Refer to **Function Key Character Table** for a complete list of special characters you can assign to each key.

Function Key Emulation is applicable for IBM PP/XT/AT, PS/2, PS/VP, COMPAQ PP, HP Vectra PP, Notebook PP, APPLE and PowerMac, and WYSE PP Enhanced or fully compatible machines.

Function Key Character Table

	Category	Function Key Character	Option Code
1	Control Key	L-Ctrl + 2	01 1F
2	Control Key	L-Ctrl + a	01 04
3	Control Key	L-Ctrl + b	01 05
4	Control Key	L-Ctrl + c	01 06
5	Control Key	L-Ctrl + d	01 07
6	Control Key	L-Ctrl + e	01 08
7	Control Key	L-Ctrl + f	01 09
8	Control Key	L-Ctrl + g	01 0A
9	Control Key	L-Ctrl + h	01 0B
10	Control Key	L-Ctrl + i	01 0C
11	Control Key	L-Ctrl + j	01 0D
12	Control Key	L-Ctrl + k	01 0E
13	Control Key	L-Ctrl + l	01 0F
14	Control Key	L-Ctrl + m	01 10
15	Control Key	L-Ctrl + n	01 11
16	Control Key	L-Ctrl + o	01 12
17	Control Key	L-Ctrl + p	01 13
18	Control Key	L-Ctrl + q	01 14
19	Control Key	L-Ctrl + r	01 15
20	Control Key	L-Ctrl + s	01 16
21	Control Key	L-Ctrl + t	01 17
22	Control Key	L-Ctrl + u	01 18
23	Control Key	L-Ctrl + v	01 19
24	Control Key	L-Ctrl + w	01 1A
25	Control Key	L-Ctrl + x	01 1B
26	Control Key	L-Ctrl + y	01 1C
27	Control Key	L-Ctrl + z	01 1D
28	Control Key	L-Ctrl + [01 2F
29	Control Key	L-Ctrl + \	01 31
30	Control Key	L-Ctrl +]	01 30
31	Control Key	L-Ctrl + 6	01 23
32	Alt Key	L-Alt + a	04 04
33	Alt Key	L-Alt + b	04 05
34	Alt Key	L-Alt + c	04 06
35	Alt Key	L-Alt + d	04 07
36	Alt Key	L-Alt + e	04 08
37	Alt Key	L-Alt + f	04 09
38	Alt Key	L-Alt + g	04 0A
39	Alt Key	L-Alt + h	04 0B
40	Alt Key	L-Alt + i	04 0C

	Category	Character	Option Code
41	Alt Key	L-Alt + j	04 0D
42	Alt Key	L-Alt + k	04 0E
43	Alt Key	L-Alt + l	04 0F
44	Alt Key	L-Alt + m	04 10
45	Alt Key	L-Alt + n	04 11
46	Alt Key	L-Alt + o	04 12
47	Alt Key	L-Alt + p	04 13
48	Alt Key	L-Alt + q	04 14
49	Alt Key	L-Alt + r	04 15
50	Alt Key	L-Alt + s	04 16
51	Alt Key	L-Alt + t	04 17
52	Alt Key	L-Alt + u	04 18
53	Alt Key	L-Alt + v	04 19
54	Alt Key	L-Alt + w	04 1A
55	Alt Key	L-Alt + x	04 1B
56	Alt Key	L-Alt + y	04 1C
57	Alt Key	L-Alt + z	04 1D
58	Alt Key	L-Alt + [04 2F
59	Alt Key	L-Alt + \	04 31
60	Alt Key	L-Alt +]	04 30
61	Alt Key	L-Alt + 6	04 23
62	Function Key	F1	00 3A
63	Function Key	F2	00 3B
64	Function Key	F3	00 3C
65	Function Key	F4	00 3D
66	Function Key	F5	00 3E
67	Function Key	F6	00 3F
68	Function Key	F7	00 40
69	Function Key	F8	00 41
70	Function Key	F9	00 42
71	Function Key	F10	00 43
72	Function Key	F11	00 44
73	Function Key	F12	00 45
74	Function Key	F13	00 68
75	Function Key	F14	00 69
76	Function Key	F15	00 6A
77	Function Key	F16	00 6B
78	Function Key	F17	00 6C
79	Function Key	F18	00 6D
80	Function Key	F19	00 6E

	Category	Character	Option Code
81	Function Key	F20	00 6F
82	Function Key	F21	00 70
83	Function Key	F22	00 71
84	Function Key	F23	00 72
85	Function Key	F24	00 73
86	Keypad	Num Lock	00 53
87	Keypad	Keypad +	00 57
88	Keypad	Keypad -	00 56
89	Keypad	Keypad *	00 55
90	Keypad	Keypad /	00 54
91	Keypad	Keypad Delete	00 63
92	Keypad	Keypad 0 (Insert)	00 62
93	Keypad	Keypad 1 (End)	00 59
94	Keypad	Keypad 2 (Down)	00 5A
95	Keypad	Keypad 3 (Page Down)	00 5B
96	Keypad	Keypad 4 (Left)	00 5C
97	Keypad	Keypad 5	00 5D
98	Keypad	Keypad 6 (Right)	00 5E
99	Keypad	Keypad 7 (Home)	00 5F
100	Keypad	Keypad 8 (Up)	00 60
101	Keypad	Keypad 9 (Page Up)	00 61
102	Keypad	Keypad Enter	00 58
103	Modifier Key	L-Ctrl (Make)	11 EE
104	Modifier Key	L-Shift (Make)	22 EE
105	Modifier Key	L-Alt (Make)	44 EE
106	Modifier Key	L-Win (Make)	88 EE
107	Modifier Key	L-Ctrl (Break)	11 00
108	Modifier Key	L-Shift (Break)	22 00
109	Modifier Key	L-Alt (Break)	44 00
110	Modifier Key	L-Win (Break)	88 00
111	Modifier Key	Home	00 4A
112	Modifier Key	End	00 4D
113	Modifier Key	Page Up	00 4B
114	Modifier Key	Page Down	00 4E
115	Modifier Key	Up Arrow	00 52
116	Modifier Key	Down Arrow	00 51
117	Modifier Key	Left Arrow	00 50
118	Modifier Key	Right Arrow	00 4F
119	System & Edit Key	Tab	00 2B
120	System & Edit Key	ESC	00 29

	Category	Character	Option Code
121	System & Edit Key	Print Screen	00 46
122	System & Edit Key	Pause/Break	00 48
123	System & Edit Key	Caps Lock	00 39
124	System & Edit Key	Scroll Lock	00 47
125	System & Edit Key	Insert	00 49
126	System & Edit Key	Delete	00 4C
127	System & Edit Key	Back Space	00 2A
128	System & Edit Key	Enter (CR)	00 28
129	System & Edit Key	Null	00 00

Examples of Usage:

1. Set Enter on the Keypad as the Record Suffix under HID Keyboard interface:

1. Replace **Enter (CR)** with **Enter Keypad** by programming the scanner with the following command line:

```
[PROGRAM] [User-defined Function Key] [0D] [0058] [END]
```

In the command line, option code 1 [0D] is the hex value identifier of Enter (CR) in the default function key table, and option code 2 [0058] is the 4-digit code of Keypad Enter.

2. Set Enter Keypad as the user-defined character of Record Suffix (Keyboard) with the following command line:

```
[PROGRAM] [Record Suffix (Keyboard)] [5] [0D] [FIN] [END]
```

In the command line, option code 1 [5] is for selecting the user-defined character as the record suffix, and option code 2 [0D] is the identifier of Enter Keypad.

2. Replace the noninitial FNC1 in GS1 barcodes with Ctrl characters under HID Keyboard interface:

- i. Replace any two function keys with Ctrl characters with following two command lines:

```
[PROGRAM] [User-defined Function Key] [1E] [010A] [END]
```

```
[PROGRAM] [User-defined Function Key] [1F] [0116] [END]
```

In the first command line, option code 1 [1E] is the hex value identifier of the target function key slot, and option code 2 [010A] is the 4-digit code of Ctrl + g.

In the second command line, option code 1 [1F] is the hex value identifier of another target function key slot, and the option code 2 [0116] is the 4-digit code of Ctrl + s.

- ii. Replace noninitial FNC1 with user-defined Ctrl characters with following command line:

```
[PROGRAM] [Noninitial FNC1 Transmit] [2] [1E] [1F] [FIN] [END]
```

In the command line, option code 1 [2] is for selecting user-defined characters as the converted output for FNC1 characters, and option code 2 [1E] and [1F] are to set Ctrl + g and Ctrl + s as the user-defined characters.

Code Page

Table of corresponding languages

Description	Code Page	Description	Code Page
Albanian	850	Hungarian	852
Arabic	1256	Icelandic	850
Arabic	720	Italian	850
Baltic	1257	Japanese	932
Bulgarian	866	Korean	949
Catalan	850	Latin 1	1252
Croatian	852	Latin 2	1250
Cyrillic	1251	Latin 5	1254
Czech	852	Latin American	850
Danish	850	Latvian	775
Dutch	850	Lithuanian	775
Estonian	775	Norwegian	850
English - United Kingdom	850	Polish	852
English - Australia	850	Portuguese	850
English - Canada	850	Romanian	852
English - New Zealand	850	Russian	866
English - United States	437	Serbian	855
English - South Africa	437	Slovakian	852
English - Philippines	437	Slovenian	852
Finnish	850	Spanish	850
French	850	Swedish	850
German	850	Chinese (Tradition)	950
Greece	737	Chinese (Simple)	936
Greece	1253	Thai	874
Hebrew - write	1255	Turkish	857
Hebrew Israel	862	Vietnamese	1258

Unicode Hex Input Setup

1. Windows-Setting up the Windows Registry

Step 1: Open the Registry Editor. You can do so by typing "regedit" in the "Search Windows" function or in Command Prompt.

Step 2: Go to HKEY_CURRENT_USER\Control Panel\Input Method

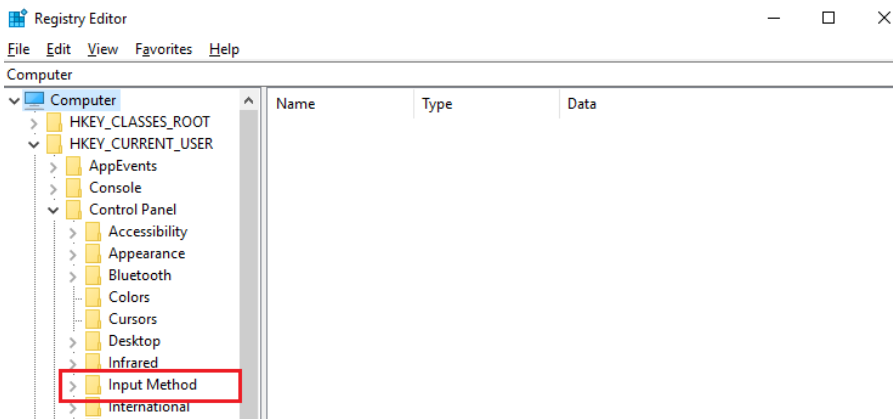

Step 3: Right-click on your mouse or press shift + F10 (on keyboard) to add a new String Value (of type "REG_SZ").

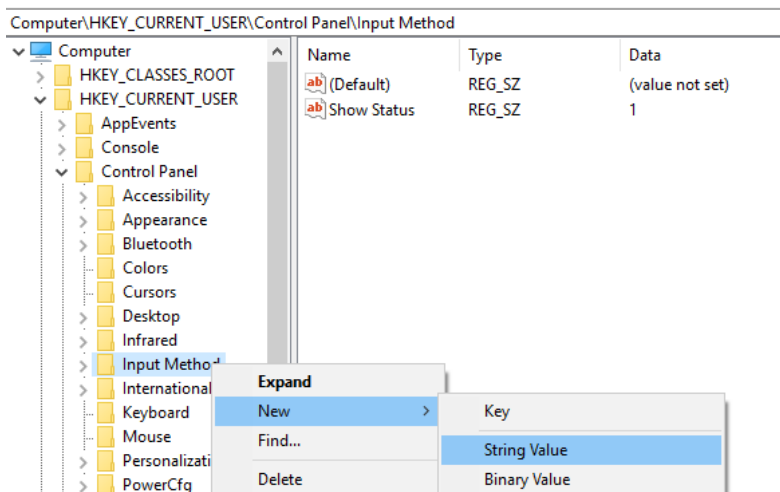

Step 4: Name the new String value as "EnableHexNumpad" and set its Value data to "1".

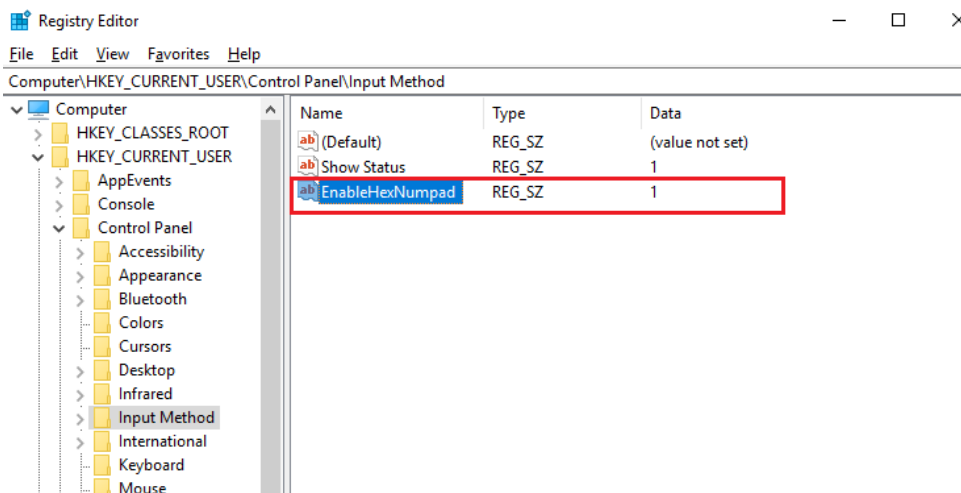

Step 5: Reboot the computer.

2. **MAC - Adding Unicode Hex Input in menu bar**

Step 1: Go to the Apple Menu -> System Preferences -> Keyboard



Step 2: On the Keyboard tab, click on "Input Sources" and check the "Show Input menu in menu bar" box.

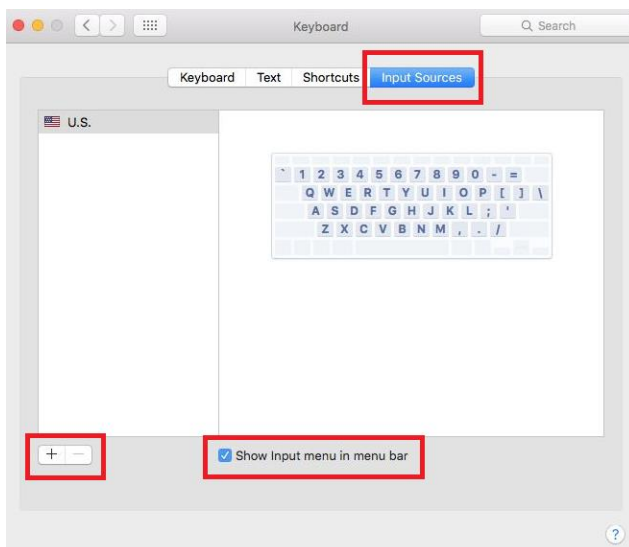

Step 3: Click the "+" button to add an input source.

Step 4: Scroll to and select "Others". Click on "Unicode Hex Input" (you can also use the Search function to find it). When done, click on the "Add" button.

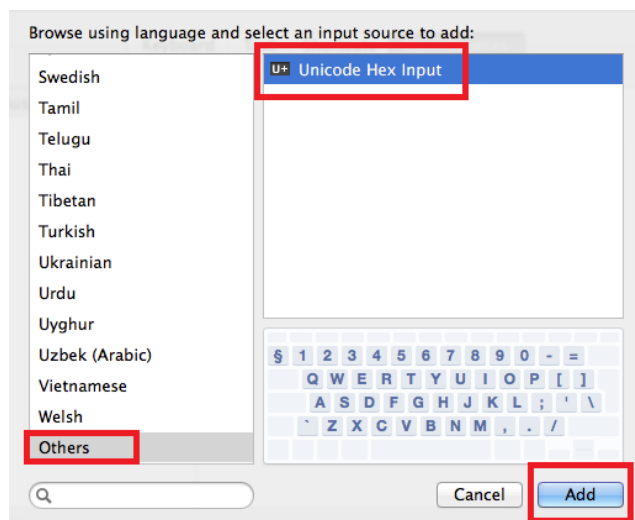

Step 5: Close the Keyboard Preferences menu.

Step 6: Change the input selection to Unicode Hex Input in the menu bar.

