

TX210 Series

■ Thermal Transfer ■ Direct Thermal
Desktop Barcode Printers



Series Lists:

TX210 / TX310 / TX610

User Manual

Copyright Information

©2021 TSC Auto ID Technology Co., Ltd.

The copyright in this manual, the software and firmware in the printer described are owned by TSC Auto ID Technology Co., Ltd. All rights reserved.

CG Triumvirate is a trademark of Agfa Corporation. CG Triumvirate Bold Condensed font is under license from the Monotype Corporation. Windows is a registered trademark of Microsoft Corporation.

All other trademarks are the property of their respective owners. Information in this document is subject to change without notice and does not represent a commitment on the part of TSC Auto ID Technology Co. No part of this manual may be reproduced or transmitted in any form or by any means, for any purpose other than the purchaser's personal use, without the expressed written permission of TSC Auto ID Technology Co.



Table of Contents

1. Introduction	1
1.1 Product Specification and Features	2
2. Operation Overview.....	6
2.1 Unpacking and Inspection.....	6
2.2 Printer Overview	7
2.2.1 Front View.....	7
2.2.2 Interior View	8
2.2.3 Rear View.....	9
3. Setup.....	10
3.1 Setting up the Printer	10
3.2 Loading the Ribbon.....	11
3.3 Loading the Media	14
3.4 Loading the Media in Cutter Mode (Option).....	16
4. LED and Button Functions.....	17
4.1 LED Indication and Key.....	17
4.2 Regular Button Function	18
4.3 Power-on Utilities.....	19
5. TSC Console.....	20

5.1 Start TSC Console	20
5.2 Setup Ethernet Interface	22
5.3 Set WiFi and Add to TSC Console Interface	24
5.4 Initialize the Printer WiFi Setting	27
5.5 TPH Care.....	28
5.6 Printer Function	29
5.7 Setting Post-Print Action	30
6. LCD Menu Function.....	31
6.3 TSPL.....	33
6.4 ZPL2.....	35
6.5 Sensor	38
6.6 Interface.....	39
6.6.1 Serial Comm.....	40
6.6.2 Ethernet.....	41
6.6.3 Bluetooth.....	42
6.6.4 Wi-Fi.....	43
6.7 File Manager	44
6.8 Diagnostic.....	45
6.9 Advanced.....	46
6.10 Service.....	47



7. TroubleShooting	48
8. Maintenance.....	51
9. Agency Compliance and Approvals	53
10. Revise History	56

1. Introduction

Thank you very much for purchasing TSC bar code printer.

The TX210 series of thermal transfer desktop barcode printers supports more printing applications than any other printer in its class. With three models available, the four inch wide TX210 series can address everything from higher volume 4x6 shipping labels, higher resolution product marking and graphic solutions, to high resolution labels used in electronics marking applications.

The printers use a large 300 meter ribbon supply on a one inch core that saves both time and money. The TX210 series features a user-friendly spring-loaded center-biased clamshell design for easy drop-in media loading of 5-inch rolls of media. The printer construction features a rugged double-wall design that is stronger and more durable than other thermal transfer mechanisms on the market. Its strong motor is powerful enough to handle a 300-meter-long ribbon.

As with all TSC printers, the TX210 Series features the TSPL-EZD printer-control language, which is fully compatible with other TSC printer languages, while supporting TPLE (Translation Printer Language Eltron®), TPLZ (Translation Printer Language Zebra®) and TPLD (Translation Printer Language Datamax®). The languages automatically decipher and translate the format of each label as it is sent to the printer. TSPL-EZD also features internal scalable True Type fonts (based on the Monotype® font engine), which are typically found only in more expensive printers.

This document provides an easy reference for operating this printer. TSC printers include the Windows labeling software for creating your label template. For system integration, the TSPL/TSPL2 printer programming manual or SDKs can be found on TSC website at: <https://www.tscprinters.com>.

1.1 Product Specification and Features

Printer model	TX210	TX310	TX610
Resolution	8 dots/mm (203 DPI)	12 dots/mm (300 DPI)	24 dots/mm (600 DPI)
Printing method	Thermal transfer and direct thermal		
Print speed	203 mm (8")/second	152 mm (6")/second	102 mm (4")/second
Max. print width	108 mm (4.25")	106 mm (4.17")	106 mm (4.17")
Max. print length	25,400 mm (1000")	11,430 mm (450")	2540 mm (100")
Enclosure	Clamshell with double-walled plastic		
Ribbon	1" paper core, 300m long, max. OD 67 mm		
Ribbon width	40~110 mm		
Processor	32-bit RISC CPU		
Memory	<ul style="list-style-type: none"> ■ 128 MB Flash memory ■ 128 MB SDRAM ■ microSD Flash memory card reader for Flash memory expansion, up to 32 GB 		
Interface	<ul style="list-style-type: none"> ■ RS-232 ■ USB 2.0 ■ Ethernet ■ USB host ■ Internal Bluetooth MFi 5.0 (factory option) ■ Parallel port (factory option) ■ 802.11 a/b/g/n/ac Wi-Fi + BT combo module (user option) 		
Power	TX210 & TX310 adaptor spec: <ul style="list-style-type: none"> ■ Input: AC 100-240V, 50-60Hz ■ Output: DC 24.0V, 3.75A, 90.0W 		

TX610 adaptor spec:

- Input: AC 100-240V, 50-60Hz
- Output: DC 24.0V, 5.41A, 130.0W

LCD model

- LCD display
 - 3.5" color TFT display, 320x240 pixels
- 6 Buttons
 - Navigation buttons, 4 buttons for up, down, left and right
 - 1 MENU button
 - 1 FEED/PAUSE/SELECT button

LED model

- Icon panel with 8 icons for indicating printer status
- 1 FEED/PAUSE button

Sensors

- Transmissive gap sensor
- Black mark reflective sensor (position adjustable)
- Ribbon encode sensor
- Head open sensor
- Transmissive gap sensor
- Black mark reflective sensor (position adjustable)
- Ribbon end sensor
- Ribbon encode sensor
- Head open sensor

Real time clock

- LCD model: standard
- LED model: optional

Internal font

- 8 alpha-numeric bitmap fonts
- One Monotype Imaging® CG Triumvirate Bold Condensed scalable font

Bar code

- 1D barcode list: Code128UCC, Code128 subsets A · B · C, EAN128, Interleaved 2 of 5, Interleaved 2 of 5 with check digit, Standard 2 of 5, Insuatrial 2 of 5, Code39, Code39 with check digit, Code93, EAN13, EAN8, UPCA, UPCE, EAN and UPC 2 (5) digits add-on, Codabar, Postnet, MSI, MSI with check digit, PLESSEY, China post, ITF14, EAN14, Code11, TELEPEN, TELEPEN number, PLANET, Code49, Deutsche Post Identcode, Deutsche Post

	Leitcode, LOGMARS
	➤ 2D barcode list: CODABLOCK F mode, GS1 DataBar, GS1 DataMatrix, Maxicode, AZTEC, PDF417, QR Code, Micro PDF417, TLC39
Font & bar code rotation	0, 90, 180, 270 degree
Printer language	TSPL-EZD (Compatible to EPL, ZPL, ZPL II, DPL)
Media type	Continuous, black mark, label with gap, notch media, punched hole media
Media width	19 mm ~ 112 mm
Media thickness	0.055mm~0.0254mm
Media ID core	1" and 1.5" paper core
Label length	3 mm ~ Max. length
Environment condition	<ul style="list-style-type: none"> ■ Operation: 5 ~ 40°C, 25~85% non-condensing ■ Storage: -40 ~ 60 °C, 10~90% non-condensing
Safety regulation	FCC Class B, CE Class B, RCM, UL, cUL, TUV/safety, CCC, BIS, EAC, BSMI, KC, Mexico CoC
Environmental concern	Comply with RoHS, WEEE, REACH
Accessories	<ul style="list-style-type: none"> ■ Windows labeling software CD disk ■ Quick start guide ■ USB cable ■ Power cord ■ External universal switching power supply ■ 1" ribbon spindle x 2 pcs ■ 1" ribbon paper core x 1 pcs
Factory option	<ul style="list-style-type: none"> ■ Internal Bluetooth 5.0 MFi ■ Parallel port (factory option)

Dealer option

- Peel-off module
- Guillotine cutter (full cut cutter)
- 802.11 a/b/g/n/ac Wi-Fi + BT combo module

User option

- USB cable (1.5M)
- External roll mount with 3" core label spindle

2. Operation Overview

2.1 Unpacking and Inspection

This printer has been specially packaged to withstand damage during shipping. Please carefully inspect the packaging and printer upon receiving the bar code printer. Please retain the packaging materials in case you need to reship the printer.

Unpacking the printer, the following items are included in the carton.

- 1 printer unit
- 1 Windows labeling software/Windows driver CD disk
- 1 quick installation guide
- 1 power cord
- 1 auto switching power supply
- 1 USB interface cable
- 2 ribbon spindles
- 1 paper core

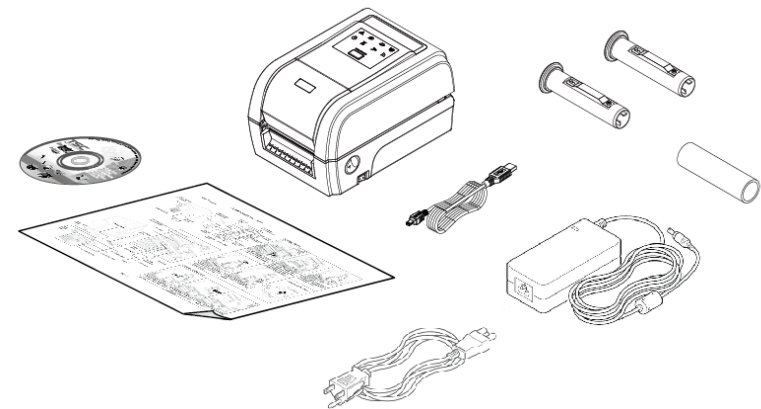

If any parts are missing, please contact the Customer Service Department of your purchased reseller or distributor.

2.2 Printer Overview

2.2.1 Front View



1. LED indicators
2. Feed/ Pause button
3. Paper exit chute
4. Top cover open lever
5. Power switch

2.2.2 Interior View



1. Ribbon rewind gear
2. Gap sensor (transmitter)
3. Media holder
4. Platen roller
5. Ribbon access cover
6. Ribbon rewind hub
7. Print head
8. Ribbon supply hub
9. Ribbon cover
10. Media holder locking switch
11. Media guides
12. Media guide adjustment button
13. Black mark sensor/ Gap sensor (receiver)

⚠ Caution:
Keep fingers and other body parts
away from the printer cover.



2.2.3 Rear View

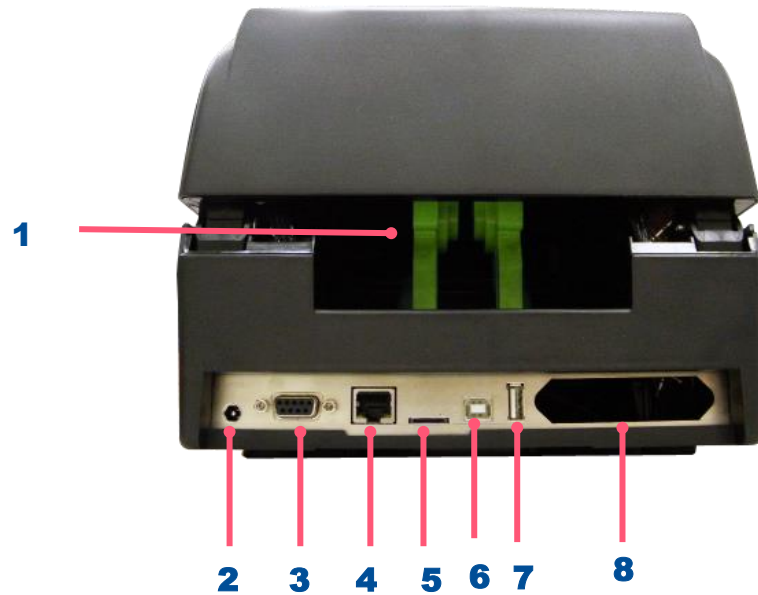

1. External label entrance chute
2. Power jack socket
3. RS-232C interface
4. Ethernet interface
5. Micro SD card socket
6. USB interface
7. USB host
8. Centronics interface (factory option)

⚠ Caution:
Keep fingers and other body parts away from the external label entrance chute.



Note: The interface picture here is for reference only. Please refer to the product specification for the interfaces availability.

3. Setup

3.1 Setting up the Printer

1. Place the printer on flat surface.
 2. Make sure the printer is power off.
 3. Connect the printer to the computer with the provided USB cable.
 4. Plug in the power cord.
- ◆ **Note: Please switch OFF the printer before plugging in the power cord to printer power jack.**

3.2 Loading the Ribbon



1. Open the printer's top cover

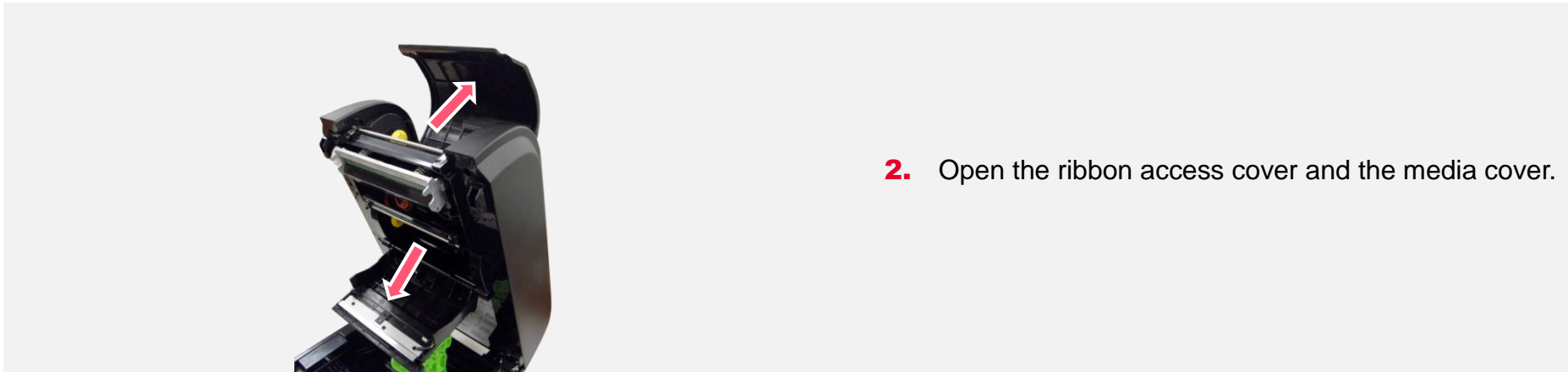

2. Open the ribbon access cover and the media cover.

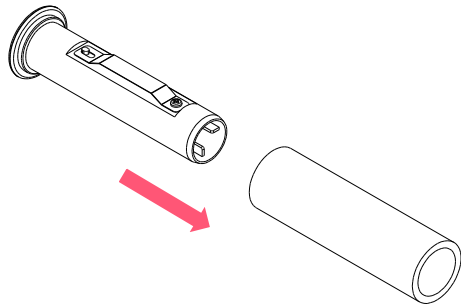

3. Insert the rewind spindle into the paper core.



4. Install the paper core right side onto the rewind hub first then align the notches on the left side and mount onto the spokes.

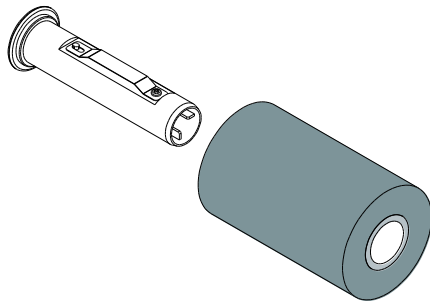

5. Insert the ribbon spindle into the ribbon core.

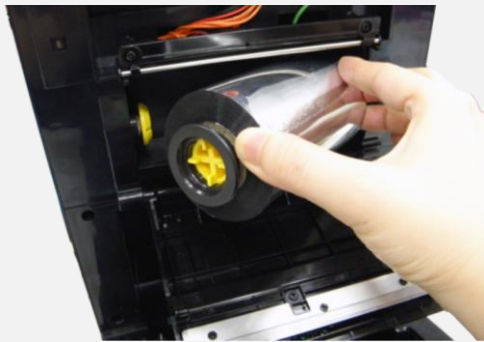

6. Install the ribbon right side onto the supply hub first then align the notches on the left side and mount onto the spokes.

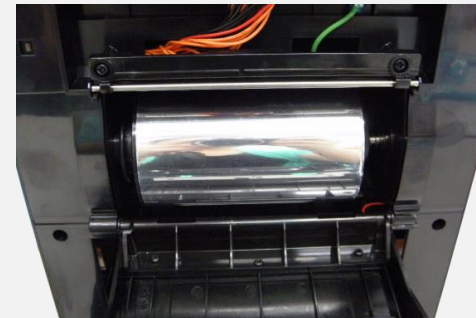

Note: The yellow part of spindle is in left side.



7. Stick the ribbon onto the ribbon rewind paper core.

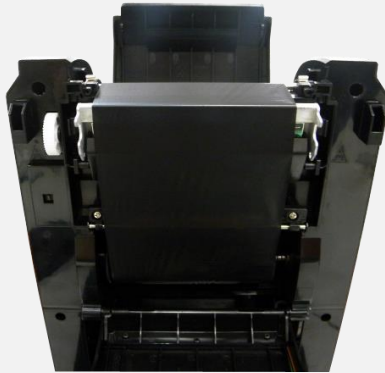

8. Turn the ribbon rewind gear until the ribbon plastic leader is thoroughly wound. Close the ribbon access cover and the top cover.



Loading path for ribbon

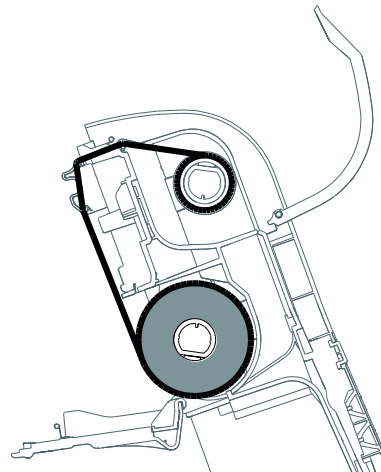

3.3 Loading the Media



1. Open the printer top cover by pulling the tabs.

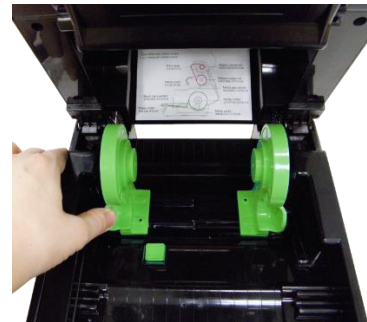

2. Separate the media holders to the label roll width.

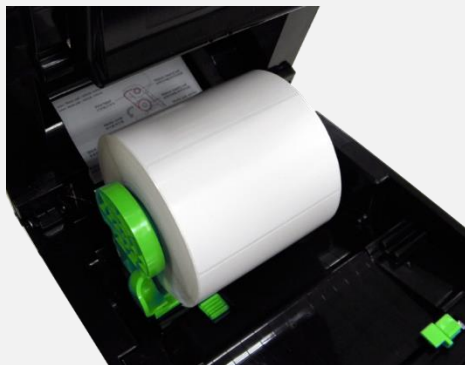

3. Place the roll between the holders.



4. Place the paper, printing side face up, through the media sensor and place the label leading edge onto the platen roller.

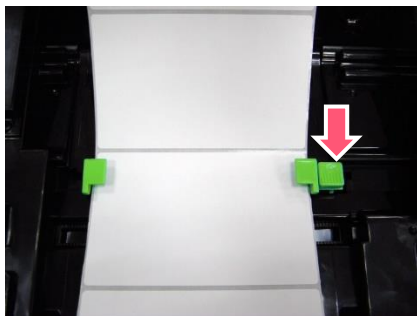

5. Move the media guides to fit the label width by pushing the media guide adjustment button.



6. Gently close the top cover, using hardware or software to make calibration. (Please refer to chapter 4&5)

3.4 Loading the Media in Peel-off Mode (Option)



1. Please refer to section 3.3 to install the media and get calibration.

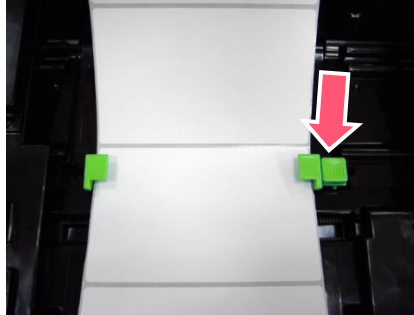

2. Move the media guides to fit the label width by pushing the media guide adjustment button.

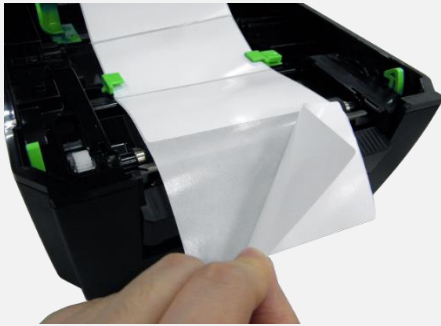

3. Pull the label through the front of the printer and take some labels off only leave the liner.



4. Open the peel-off cover. Feed the liner into peel-off cover slot.

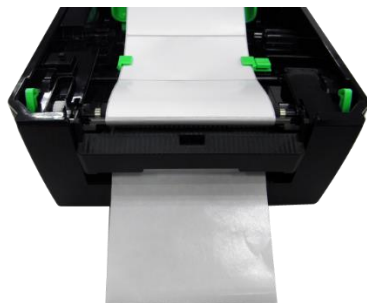

5. Close the peel-off cover and printer cover, using software to set printer's post action to Peel Off mode. (Please refer to chapter 5)



6. Print a label for test.

3.4 Loading the Media in Cutter Mode (Option)



1. Please refer to section 3.3 to install the media .



2. Lead the paper through the cutter paper opening.

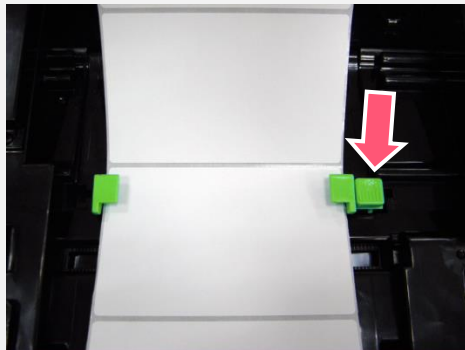

3. Move the media guides to fit the label width by pushing the media guide adjustment button.



4. Open the peel-off cover. Feed the liner into peel-off cover slot.
5. Use software to set the media sensor type, calibrate the selected sensor and set the post-print action to "CUTTER".(Please refer to chapter 5)

4. LED and Button Functions

4.1 LED Indication and Key

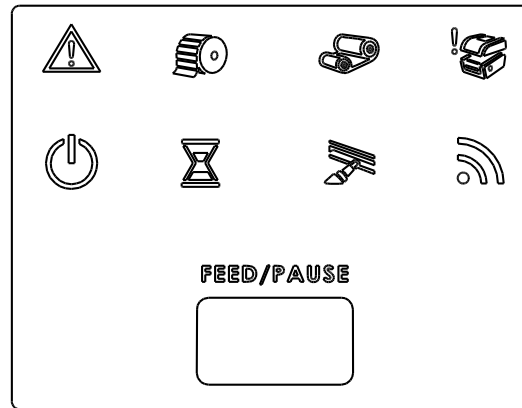

LED	Status	Indication	LED	Status	Indication
	On	Other errors		On	Printer is ready
	Blinking			Blinking	Pause
	On	Out of paper		On	Erasing memory
	Blinking	Paper jam		Blinking	Downloading file
	On	Out of ribbon		Blinking	Need to clear print head
	Blinking	Ribbon near end			
	On	Print head open		Blinking	RF communication

4.2 Regular Button Function

1. Feed labels

When the printer is ready, press the button to feed one label to the beginning of next label.

2. Pause the printing job







When the printer is printing, press the button to pause a printing job. When the printer is paused, the LED will be green blinking. Press the button again to continue the printing job.

4.3 Power-on Utilities

Power-on Utilities provides the basic functions and can be activated by below procedures:

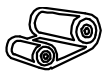
Turn off the power > **Hold** the Feed button > **Open** the power > **Release** the button depending on the the color of the LED.

Sequences of the settings:

LED Colors	Red	Red	Red	Red	Green	Green
Functions	 (5 blinks)	 (5 blinks)	 (5 blinks)	 (5 blinks)	 (5 blinks)	 (Solid)
1. Sensor Calibration (Gap / black mark sensor)	Release					
2. Self-Test (And enter dump mode)		Release				
3. Factory Default			Release			
4. Bline Calibration				Release		
5. Gap Calibration					Release	
6. READY (Skip AUTO.BAS)						Release

5. TSC Console

TSC Console is a management tool combining the Printer Management, Diagnostic Tool, CommTool and Printer Webpage settings, which enables you to adjust printer's settings/status; change printers' settings; download graphics, deploy fonts, graphics, label templates or upgrade the firmware to the group of printers, and send additional commands to printers at the same time.

※ **Printer firmware version before A2.12 will only use 9100 Port as command port; Printer firmware after A2.12 will use 6101 Port as command port.**

5.1 Start TSC Console

1. Double click TSC Console icon to start the software.

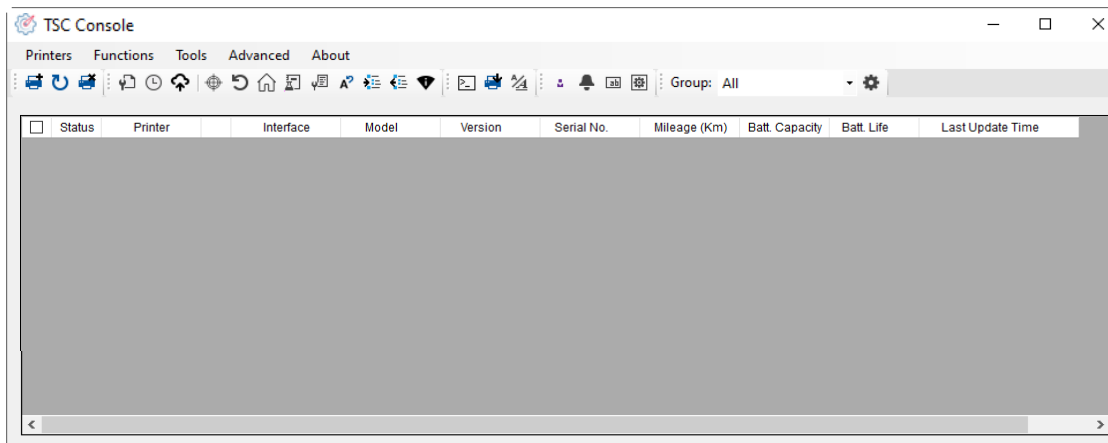

2. Manually add the devices by clicking **Printer > Add Printers**.

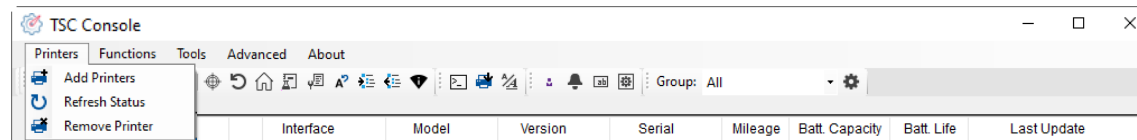

3. Select the current interface of the printer.

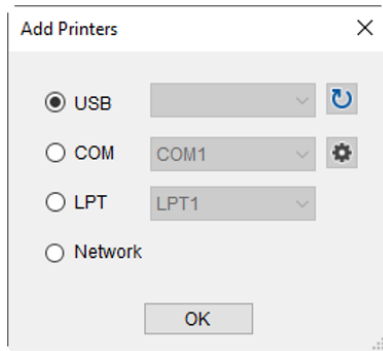

4. The printer will be added to **TSC Console**'s interface.

5. Select the printer and set the settings.

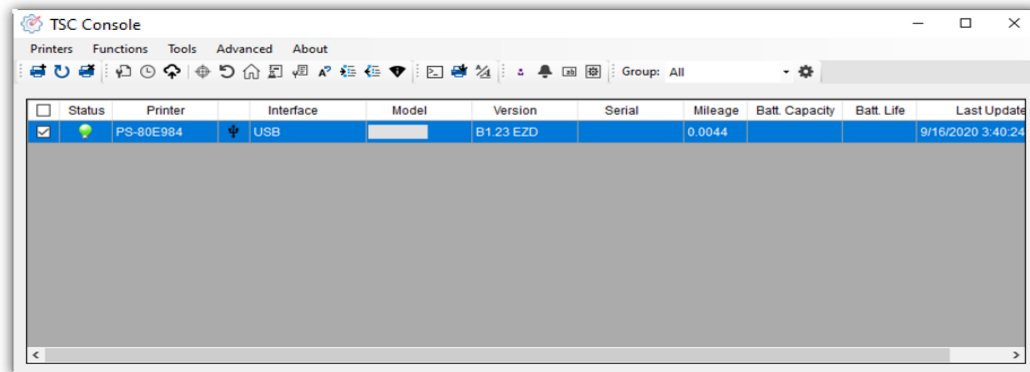

- For more information, please refer to **TSC Console User Manual**.

5.2 Setup Ethernet Interface

- Use **USB** or **COM** to establish the interface on **TSC Console**.

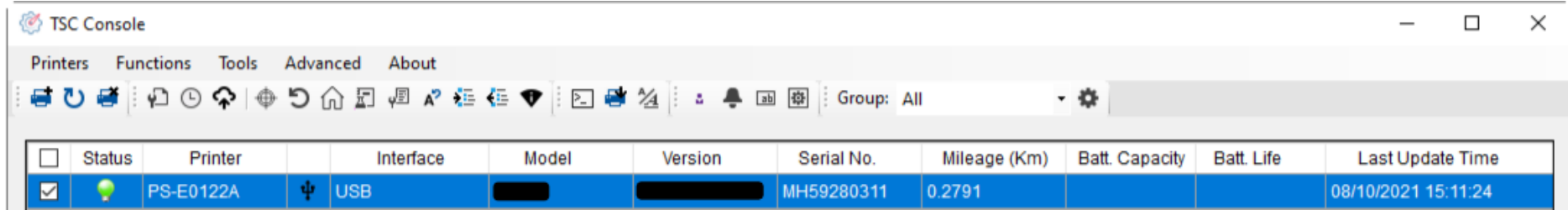

The screenshot shows the TSC Console software interface. At the top, there are menu options: Printers, Functions, Tools, Advanced, and About. Below the menu is a toolbar with various icons. A status bar at the bottom of the toolbar shows 'Group: All'. The main area contains a table with the following data:

Status	Printer	Interface	Model	Version	Serial No.	Mileage (Km)	Batt. Capacity	Batt. Life	Last Update Time
<input checked="" type="checkbox"/>	PS-E0122A	USB			MH59280311	0.2791			08/10/2021 15:11:24

- Double click to enter the **Printer Configuration Page** > Click **Ethernet** tab > Check the **IP Address**.

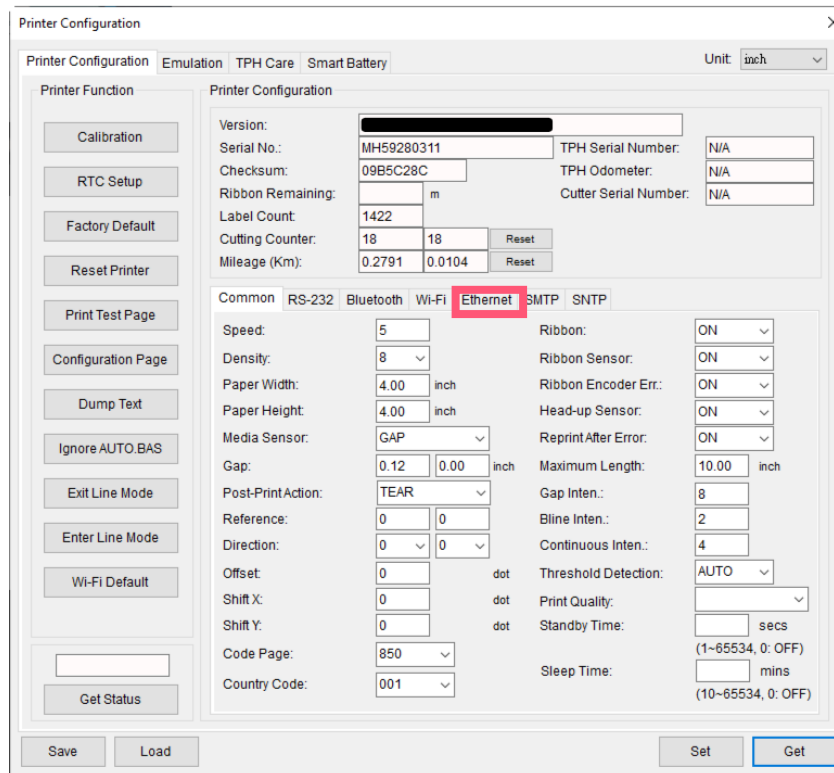

The screenshot shows the 'Printer Configuration' dialog box. The 'Printer Configuration' tab is selected. The 'Ethernet' sub-tab is highlighted with a red box. The 'DHCP' radio button is selected, and the 'Static IP' radio button is unselected. The IP Address is set to 10.0.10.181, Subnet Mask to 255.255.255.0, Gateway to 10.0.10.251, and MAC Address to 00-1B-82-E0-12-2A. A red arrow points from the 'Ethernet' sub-tab to the 'DHCP' radio button.

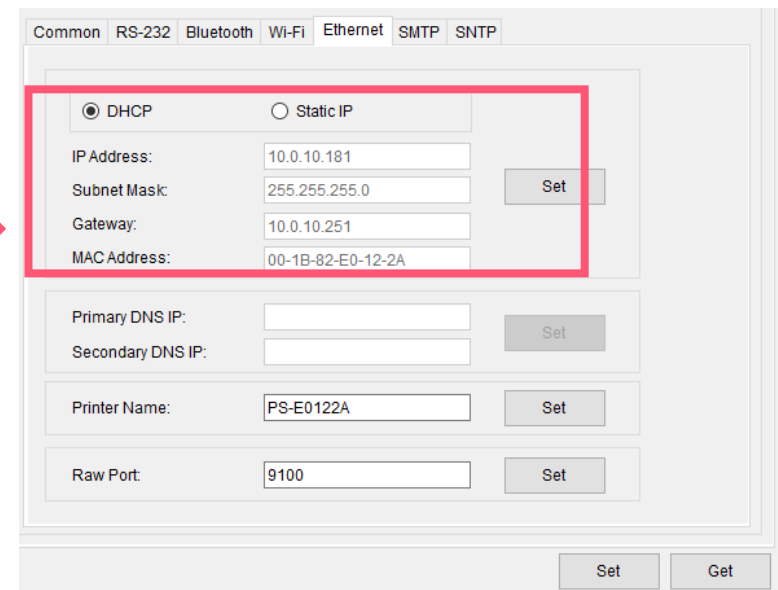

This is a close-up view of the Ethernet configuration section. It shows the 'DHCP' radio button selected and the 'Static IP' radio button unselected. The IP Address is 10.0.10.181, Subnet Mask is 255.255.255.0, Gateway is 10.0.10.251, and MAC Address is 00-1B-82-E0-12-2A. A 'Set' button is next to the IP Address field. Below this, there are fields for Primary DNS IP, Secondary DNS IP, Printer Name (PS-E0122A), and Raw Port (9100), each with a 'Set' button.

- Return to **TSC Console** main page > Click **Add Printer** on the top left of the window.

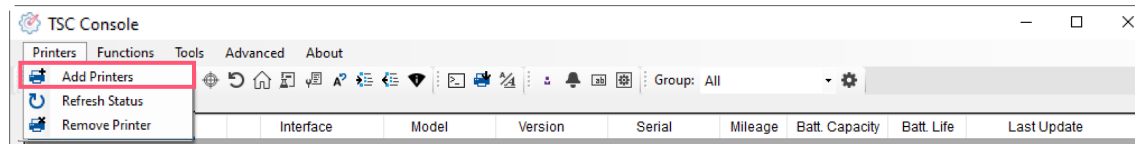

- Choose **Network** > Key in the **IP Address** > Click **Discover** to establish the Ethernet interface.

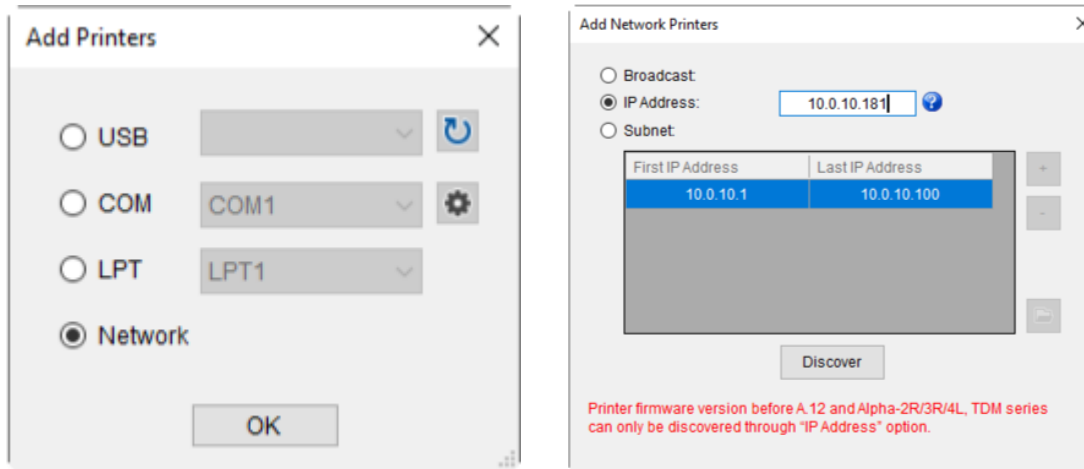

- The notification will pop up > Click **OK** to close the window > The Ethernet interface will be shown on **TSC Console**.

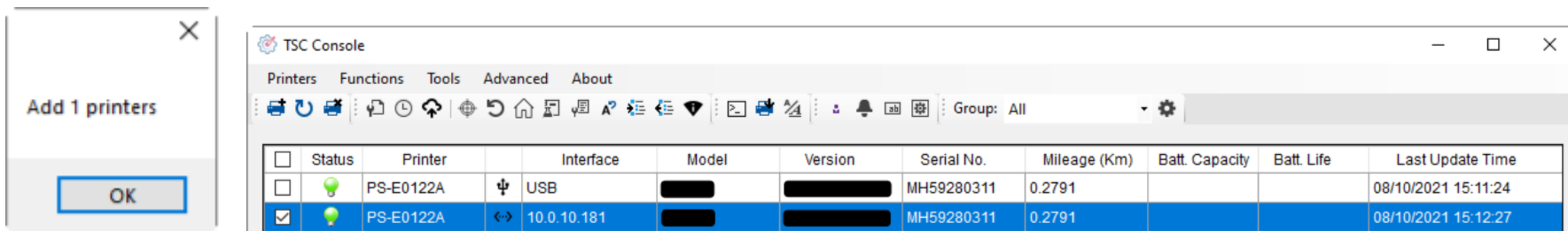

5.3 Set WiFi and Add to TSC Console Interface

- Use **USB** or **COM Port** to set up the interface.
(refer to chp.5.1)
- Double click to enter the printer configuration page.

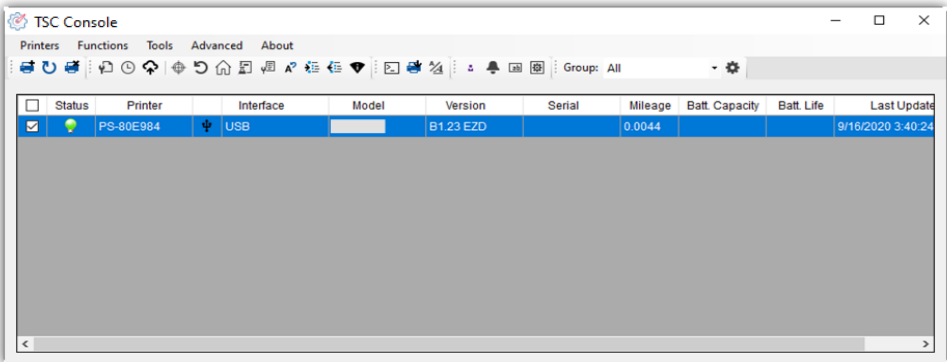

- Click **Get** to receive printer's information.
- Click **Wi-Fi** to the wi-fi setting page.

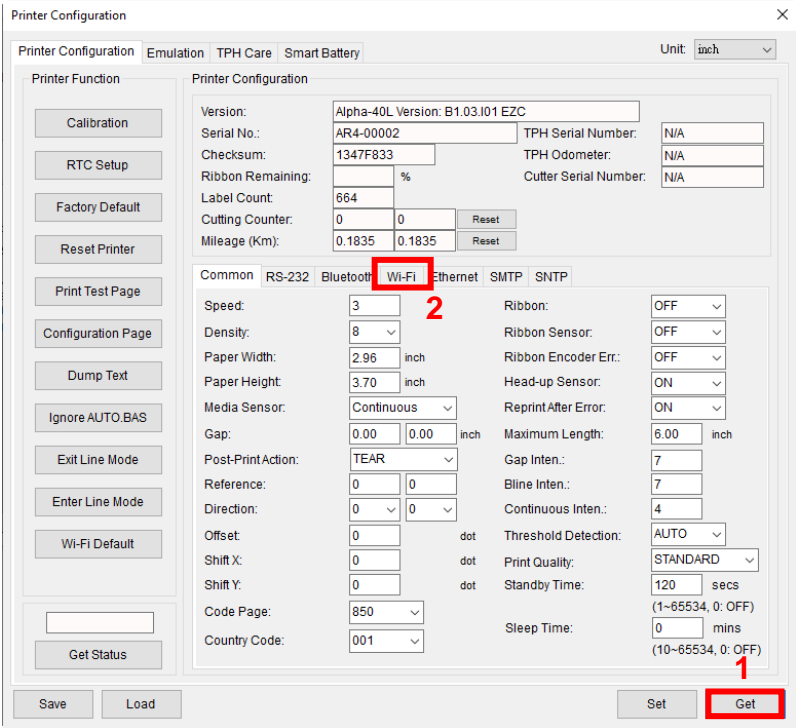

For WPA-Personal

- I. Fill-in the **SSID**.
- II. Select the Encryption option to **WPA-Personal**.
- III. Fill-in the Key.
- IV. Select **DHCP** to **ON**. (For **OFF** option, please fill-in the IP Address, Subnet Mask and Gateway)
- V. After setting, click the **Set** button.

Note:

Before setting, the entered field will be shown in yellow for reminding.

On DHCP, user can change the printer name by another model name in "Printer Name" field.

User also can change the raw port in "Raw Port" field.

Common RS-232 Bluetooth Wi-Fi Ethernet SMTP SNTP

Built-in Wi-Fi Module

SSID: SSID_1

WLAN Encryption: WPA-Personal

Key: ●●●●

DHCP: ON

IP Address: 0.0.0.0

Subnet Mask: 0.0.0.0

Gateway:

Primary DNS IP:

Secondary DNS IP:

Raw Port: 9100

Printer Name: PS-FF153C

MAC Address: 00:1B:82:FF:15:3C

EAP Type:

Username:

Password:

CA Certificate:

Client Certificate:

Private Key:

EAP-FAST PAC:

File Name Browse

Wi-Fi Version: 3.7.1.0R6

RSSI: 0

Set Get

For WPA-Enterprise

- I. Fill-in the **SSID**.
- II. Select the Encryption option to **WPA-Enterprise**.
- III. Select DHCP to **ON** (For **OFF** option, please fill-in the IP Address, Subnet Mask and Gateway)
- IV. Select the **EAP Type** option. (For **EAP-TLS** option, please upload the CA and Key for mutual authentication, integrity-protected cipher suite negotiation, and key exchange between two endpoints.)
- V. After setting, click the **Set** button.

Note:

Before setting, the entered field will be shown in yellow for reminding.

On DHCP, user can change the printer name by another model name in "Printer Name" field.

User also can change the raw port in "Raw Port" field.

Common RS-232 Bluetooth Wi-Fi Ethernet SMTP SNTP

Built-in Wi-Fi Module

SSID: SSID_2

WLAN Encryption: WPA-Enterprise

Key: ●●●●

DHCP: ON

IP Address: 0.0.0.0

Subnet Mask: 0.0.0.0

Gateway:

Primary DNS IP:

Secondary DNS IP:

Raw Port: 9100

Printer Name: PS-FF153C

MAC Address: 00:1B:82:FF:15:3C

EAP Type:

Username:

Password:

CA Certificate:

Client Certificate:

Private Key:

EAP-FAST PAC:

File Name Browse

Wi-Fi Version: 3.7.1.0R6

RSSI: 0

Set Get

- After clicking **Set** button, it'll pop-up the window tip as below shown.

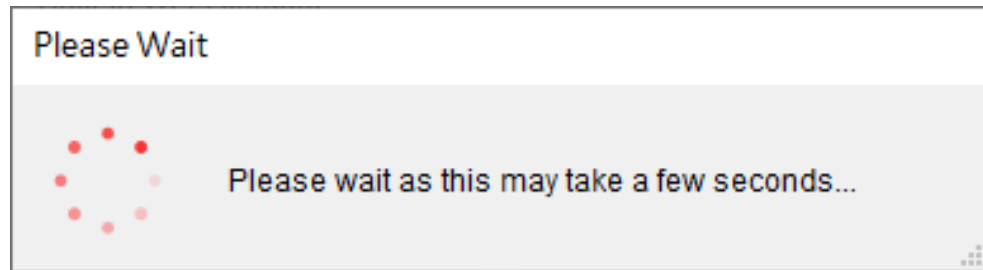

- IP address will be shown in the "IP address" field and the Wi-Fi logo and IP address will be displayed on the LCD control panel.

Note:

IP address should be shown within about 5~15 seconds after printer turn on. If not, please refer to steps below to initialize the printer Wi-Fi module settings then to setup it again.

- Remove the cable between the computer and the printer.
- Go to main page, click **Add Printer** to add the printer via **Network**.
- Select the printer and enter the setting page by double clicking the printer.
- Click the **Print Test Page** button to print the test page via Wi-Fi interface.

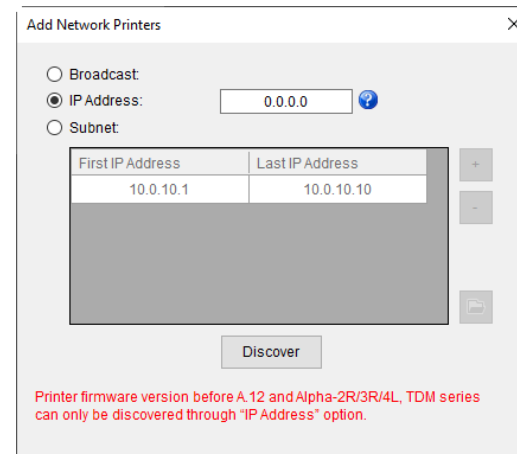

5.4 Initialize the Printer WiFi Setting

1. Return to the main page of TSC Console.

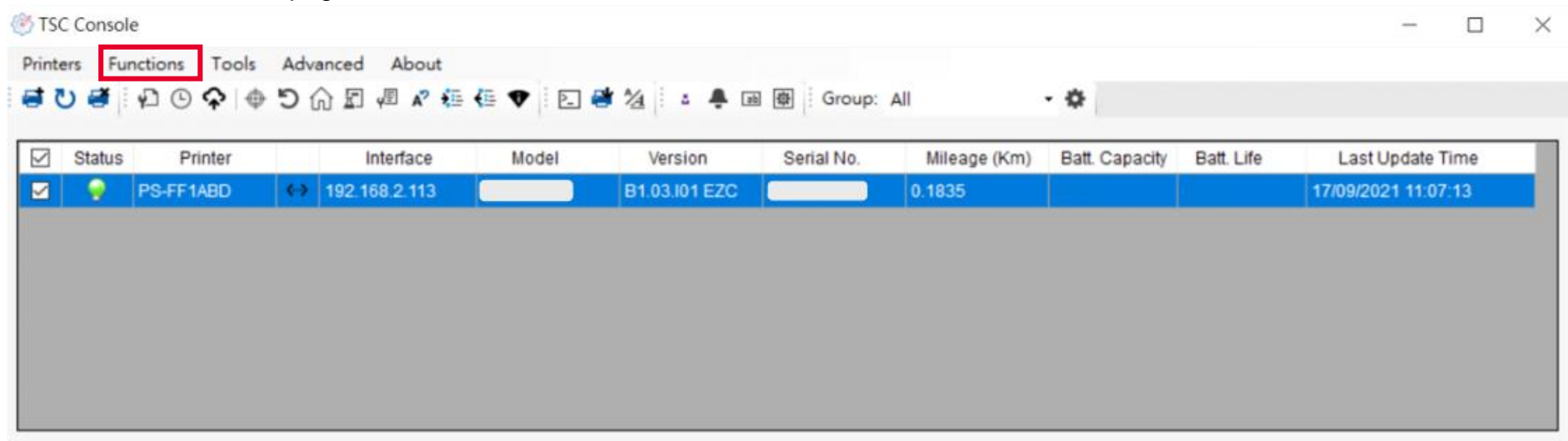

2. Click **Functions** to expand the page.
3. Click **Wi-Fi Default** to initialize the printer Wi-Fi module setting to factory default setting.

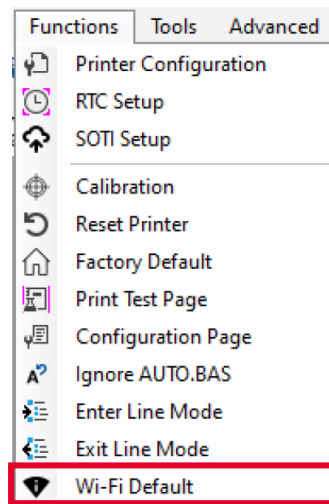

5.5 TPH Care

TPH Care provides users to check the condition of the print head and be able to set the dot failure threshold for indicating errors when the threshold is triggered.

This option is used to enable (ON)/ disable (OFF) the TPH care function.

This option is used to check the numbers of unhealthy TPH dot element.

This option is used to detect the unhealthy TPH dot.

This option is used to set the threshold for unhealthy TPH dot number.

This image is used to check the relative position of the unhealthy TPH dot.

This option is used to print a TPH test image to check the TPH printing result.

1. Enable the TPH Care function. (Note: The default is disabled/OFF.) Then click "Get TPH care profile" button and a diagram will show in the area above.
2. If the profile is flat, it means that the print head is good. Check "Unhealthy TPH dot number". If the result is zero (0), that means the print head is good.
3. Bad dots are presented as a spike in the profile. The arrow in below iprofile indicates the presence of potentially damaged dots and printer will stop printing.

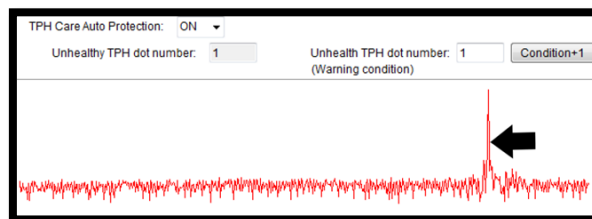

5.6 Printer Function

Printer Function could be found in **Printer Configuration**. “Printer Function” will be shown on the left side of the window.

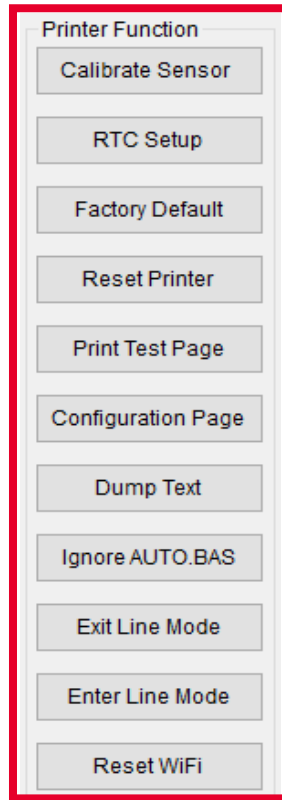

Functions	Description
Calibrate Sensor	Detect media types and the size of the label
RTC Setup	Synchronize printer with Real Time Clock on PC
Factory Default	Initialize the printer to default settings
Reset Printer	Reboot printer
Print Test Page	Print test page according to the specified label size and sensor type.
Configuration Page	Print printer configurations
Dump Text	Activate the printer to dump mode
Ignore AUTO.BAS	Ignore AUTO.BAS file when printer boot up.
Exit Line Mode	Exit the line mode to page mode
Enter Line Mode	Leave page mode and enter line mode
Reset WiFi	Restore the WiFi settings to defaults.

5.7 Setting Post-Print Action

When the printer is equipped with other option kits, ex: cutter, peeler, rewinder, please select the mode after finishing the calibration.

Follow below procedure to set the post action for the printing:

Refer Chp 5.1 to Connect the printer with **TSC Console** > **Double click** the printer > The **Printer Configuration Page** will pop up > Click **Get** to load information > Go to **Common Tab** > Find **Post-Print Action** > **Select the mode** depends on users' application > Click **Set**.

The screenshot shows the 'Printer Configuration' window with the 'Common' tab selected. The 'Post-Print Action' dropdown menu is open, showing options: OFF, TEAR, PEEL, CUTTER, REWIND, and APPLICATOR. The 'Set' and 'Get' buttons at the bottom are highlighted with red boxes. Blue circles with numbers 1, 2, and 3 indicate the sequence of actions: 1. Click 'Get', 2. Select the 'Post-Print Action' mode, 3. Click 'Set'.

Field	Value
Version:	
Serial No.:	
Checksum:	1344B9B1
Ribbon Remaining:	%
Label Count:	553
Cutting Counter:	0 0
Mileage (Km):	0.0913 0.0913
TPH Serial Number:	N/A
TPH Odometer:	N/A
Cutter Serial Number:	N/A

Field	Value
Speed:	3
Density:	8
Paper Width:	104.00 mm
Paper Height:	74.05 mm
Media Sensor:	Black Mark
Gap:	1.99 0.00 mm
Post-Print Action:	[Dropdown Menu]
Reference:	OFF
Direction:	
Offset:	
Shift X:	
Shift Y:	
Code Page:	850
Country Code:	001
Ribbon:	OFF
Ribbon Sensor:	OFF
Ribbon Encoder Err.:	OFF
Head-up Sensor:	ON
Reprint After Error:	ON
Maximum Length:	152.25 mm
Gap Inten.:	7
Blint Inten.:	7
Continuous Inten.:	4
Threshold Detection:	AUTO
Print Quality:	STANDARD
Standby Time:	120 secs
Sleep Time:	0 mins

6. LCD Menu Function

6.1 Enter the Menu

Press the “Menu” button to enter the main menu. Use the “Cross” button to select the item on main menu. The selected item will turn red. Press the “Feed” button to enter the setting list.

Note: This LCD function is optional for TX210 and TX310 series.

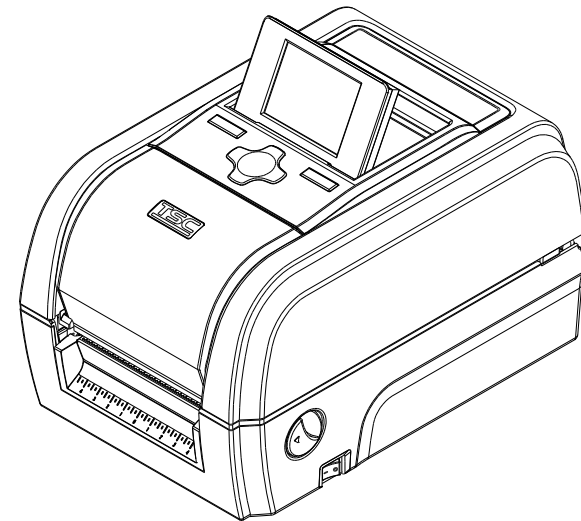

6.2 Main Menu Overview

There are 6 categories on the menu. Users can easily set the settings of the printer without connecting the computer. Please refer to following sections for more details.



Setting : To set up the printer settings for TSPL & ZPL2.



Advanced : To set LCD, initialization, cutter type,...etc.



Sensor : To calibrate the selected media sensor.



File Manager : To check and manage printer's memory storage.

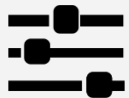

Interface : To set the printer interface settings.



Diagnostic : To check printer and help users to troubleshoot the problems.

6.3 TSPL

TSPL category can set up the printer settings for TSPL.

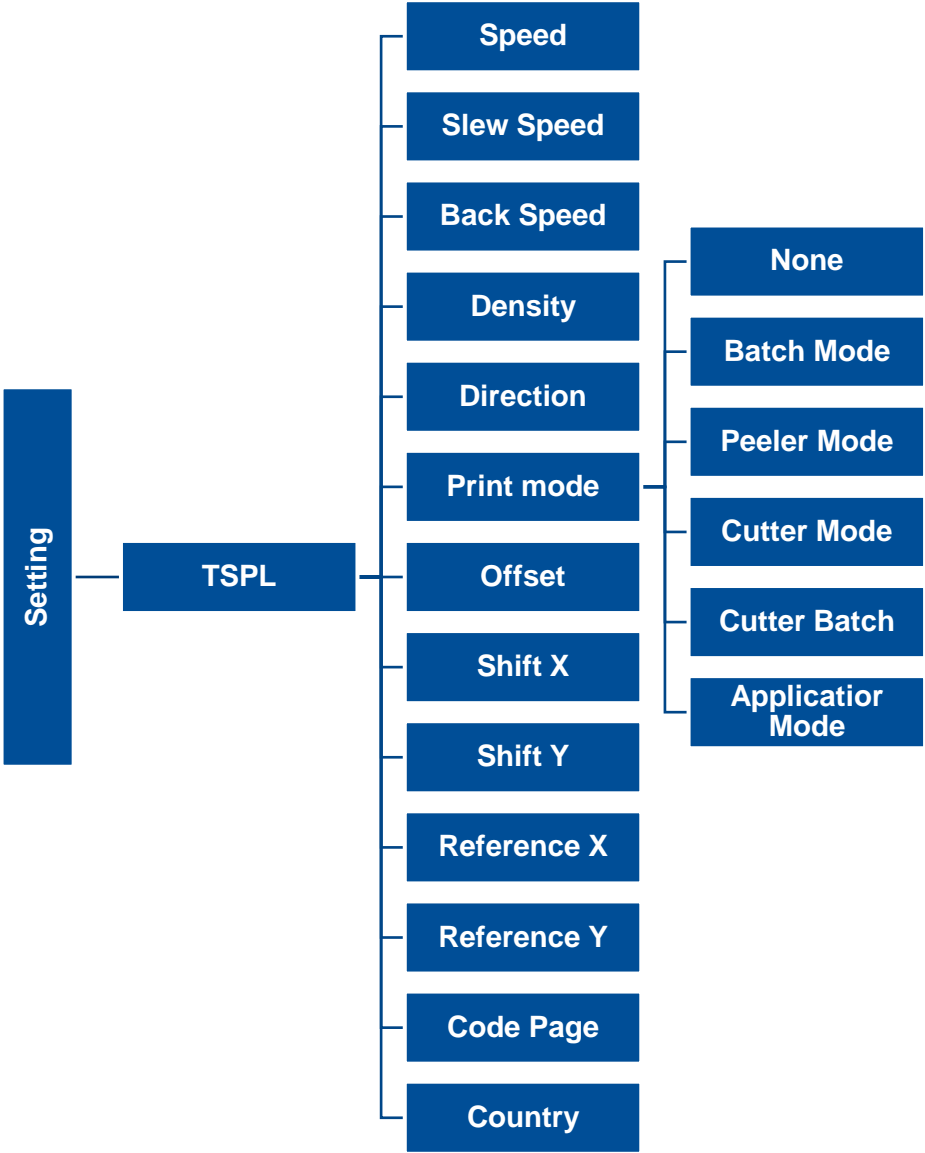

Item	Description	Default
Speed	Set the print speed.	N/A
Slew Speed	Use this item to setup feed speed. 203DPI: 1~8; 300DPI:1~6; 600DPI:1~4	N/A
Back Speed	Use this item to setup back feed speed. Setting value is from 1~3	2
Density	Set the printing darkness.	8
Direction	Set the printout direction. Setting Value: 0 and 1. Direction 0: <input type="text" value="Direction"/> Direction 1: <input type="text" value="Direction"/>	0
Print mode	Set the print mode. There are 5 modes in total: None: Next label top of form is aligned to the print head burn line location. (Tear Off Mode) Batch Mode: Once finishing the printing process, label will be fed to the tear plate location. Peeler Mode: Enable the label peel off mode. Cutter Mode: Enable the label cutter mode. Cutter Batch: Cut the label once at the end of the printing job. Applicator: The printer prints a label when it receives a signal from the applicator.	Batch Mode
Offset	Adjust media stop location. Available value setting range: -999 dots to 999 dots.	0 dot
Shift X	Adjust print position. Available value setting range: -999 dots to 999 dots.	0 dot
Shift Y		0 dot
Reference X	Set the origin of printer coordinate system horizontally and vertically. Available setting range: 0 dot to 999 dots.	0 dot
Reference Y		0 dot
Code page	Set the code page of international character set.	850
Country	Set the country code. Available setting value range: 1 to 358.	001

Note: If printing from enclosed software/driver, the software/driver will send out the commands, which will overwrite the settings set from the panel.

6.4 ZPL2

This "ZPL2" category can set up the printer settings for ZPL2.

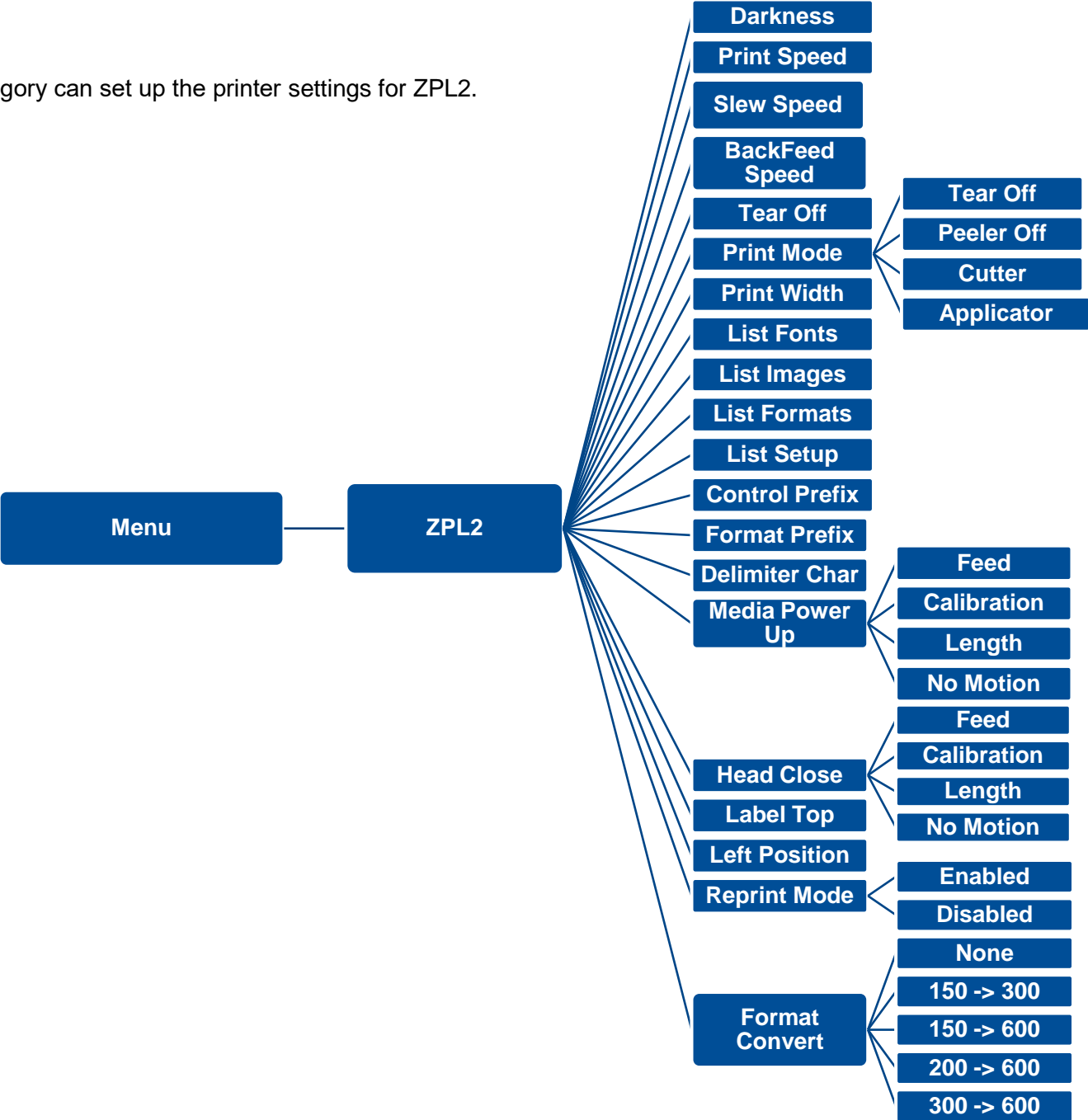

Item	Description	Default
Density	Set the printing darkness. Available setting range: 0 to 30.	16 6 (203dpi)
Print Speed	Set the print speed.	4 (300dpi) 3 (600dpi)
Slew Speed	Use this item to setup feed speed. 203DPI: 1~8; 300DPI:1~6; 600DPI:1~4	2
BackFeed Speed	Use this item to setup back feed speed. Setting value is up to 6 ips.	2 ips
Tear Off	Adjust media stop location. Available setting value range: -120~120 dots.	0 dot
Print mode	<p>Set the print mode. There are 4 modes:</p> <p>Tear Off: Next label top of form is aligned to the print head heating line location.</p> <p>Peeler Off: Enable the label peel off mode.</p> <p>Cutter: Enable the label cutter mode</p> <p>Applicator: The printer prints a label when it receives a signal from the applicator.</p>	Tear Off
Print Width	Set the print width. Available setting range: 2 ~ 999 dots.	812
List Fonts	Print the current fonts list from the memory devices to the label.	N/A
List Images	Print current printer available images list stored at the memory device to the label.	N/A
List Formats	Print current printer available formats list from the memory devices to the label.	N/A
List Setup	Print current printer configuration to the label.	N/A
Control Prefix	Set control prefix character.	N/A
Format Prefix	Set format prefix character.	N/A

Delimiter Char	Set delimiter character.	N/A
	Set the action of the media when turning on the printer.	
	Feed: Printer will advance one label.	
Media Power Up	Calibration: Printer will make calibration.	No Motion
	Length: Printer determine length and feed label.	
	No Motion: Printer will not move media.	
	Set the action of the media when closing the print head.	
	Feed: Printer will advance one label.	
Head Close	Calibration: Printer will make calibration.	No Motion
	Length: Printer determine length and feed label.	
	No Motion: Printer will not move media.	
Label Top	Adjust print position vertically on the label. Value range: -120 to +120 dots.	0
Left Position	Adjust print position horizontally on the label. Value range:-9999 to +9999 dots.	0
Reprint Mode	Reprint the last label by pressing  button on printer's control panel.	Disabled
Format Convert	Select the bitmap scaling factor. The first number is the original dots per inch (dpi) value; the second the dpi which you would like to scale.	None

Note: printing from other software/drive will overwrite the settings set from the panel.

6.5 Sensor

This option is used to calibrate the selected sensor. We recommend calibrate the sensor before printing when changing the me

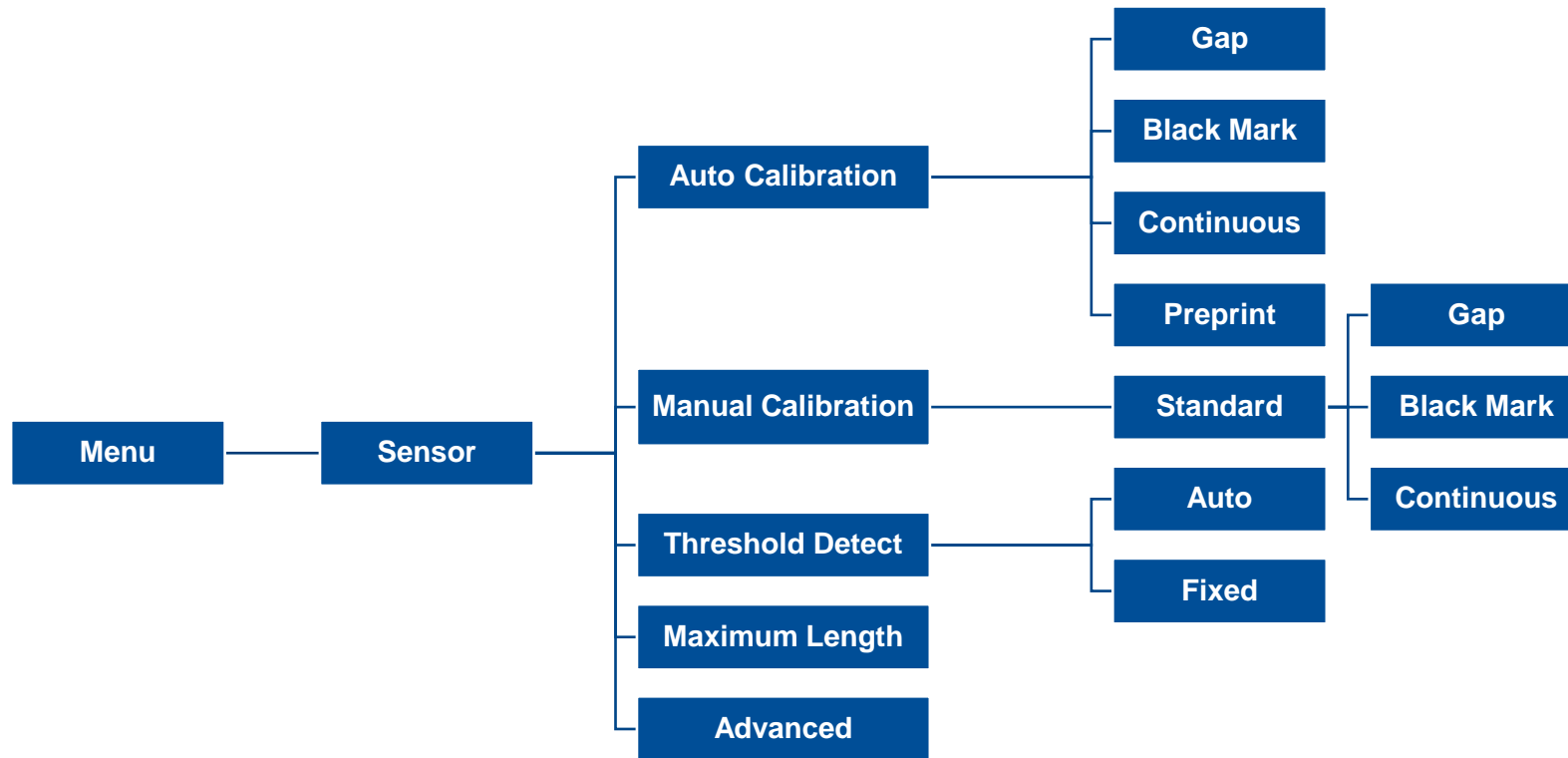

Item	Description	Default
Auto Calibration	Set the media sensor type and calibrate the selected sensor automatically.	N/A
Manual Calibration	In case Auto Calibration does not work, please use “Manual” function to set the paper length and gap/bline size to complete the calibration setting.	N/A
Threshold Detect	Set sensor sensitivity in fixed or auto.	Auto
Maximum Length	Set the maximum length for label calibration.	254 mm
Advanced	Set the minimum paper length and maximum gap/bline length for auto-calibration.	N/A

6.6 Interface

Interface can set the printer interface settings.

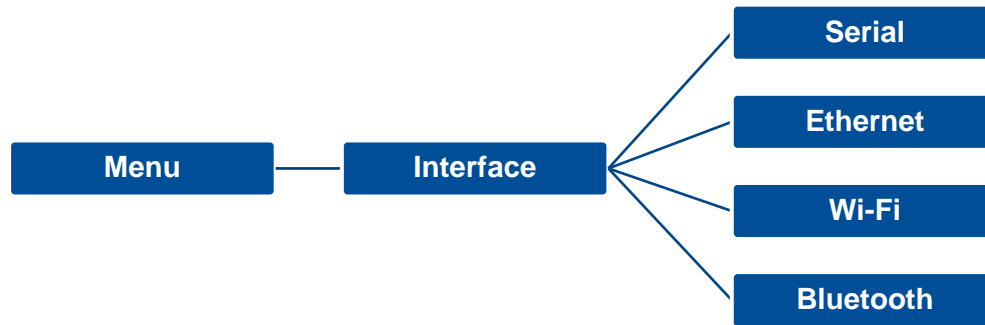

6.6.1 Serial Comm

Serial comm can set the printer RS-232 settings.

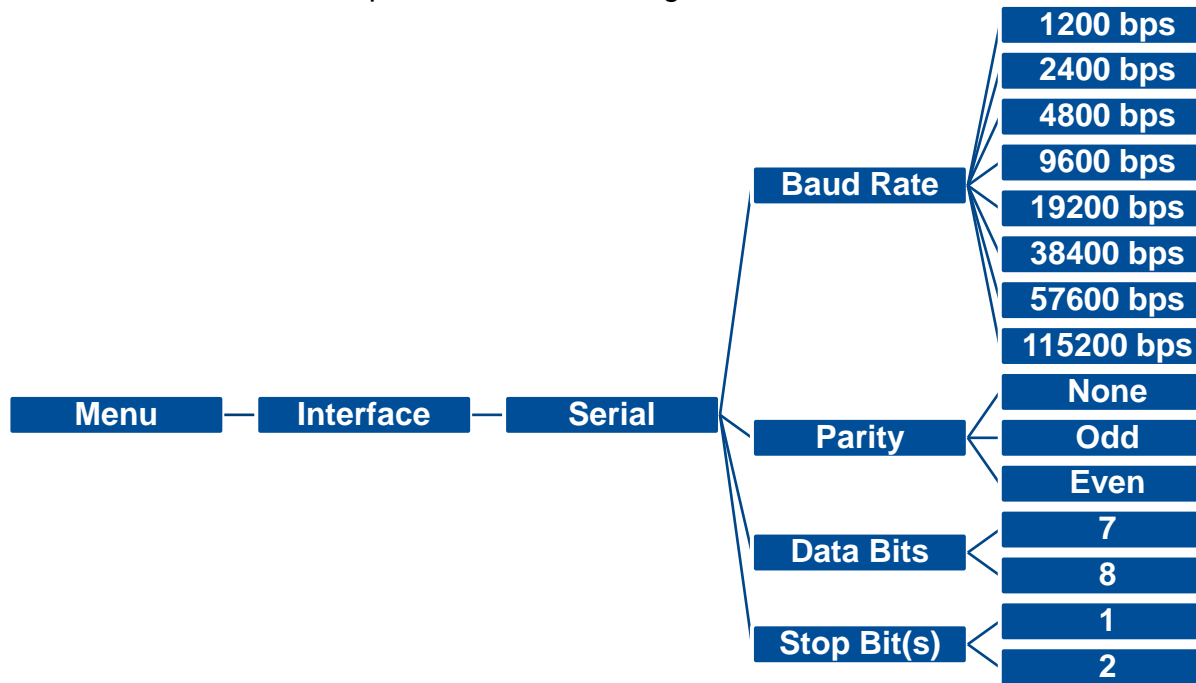

Item	Description	Default
Baud Rate	Set the RS-232 baud rate.	9600
Parity	Set the RS-232 parity.	None
Data Bits	Set the RS-232 Data Bits.	8
Stop Bit(s)	Set RS-232 Stop Bits.	1

6.6.2 Ethernet

Ethernet configures internal Ethernet configuration and checks the printer's Ethernet module status, and reset the Ethernet module.



Item	Description	Default
Status	Check the Ethernet IP address and MAC setting status.	N/A
Config.	DHCP: On or OFF the DHCP (Dynamic Host Configuration Protocol) network protocol. Static IP: Use this menu to set the printer's IP address, subnet mask and gateway.	DHCP

6.6.3 Bluetooth



Item	Description	Default
Bluetooth Name	This item is used to set the local name for Bluetooth.	PS+last 6 characters of MAC Address
Bluetooth PIN Code	This item is used to set the local PIN code for Bluetooth.	N/A

6.6.4 Wi-Fi

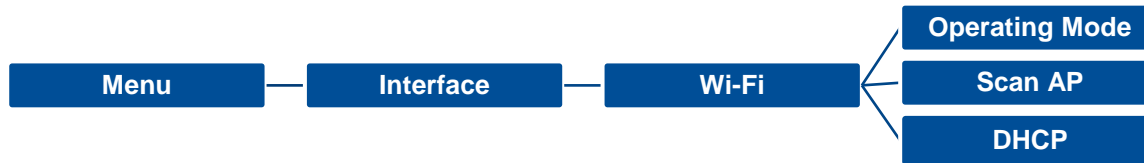

Item	Description	Default
Operating	<p>This item is used to set the operating mode of wireless local area networks to connect devices to the networks.</p> <p>Note: Infrastructure mode requires the use of an access point for this communication to take place. Ad hoc mode involves connecting a computer directly to another computer.</p>	Infrastructure
Scan AP	This item is used to scan the access point device	N/A
DHCP	<p>DHCP: On or OFF the DHCP (Dynamic Host Configuration Protocol) network protocol. Static IP: Use this menu to set the printer's IP address, subnet mask and gateway.</p>	ON

6.7 File Manager

File Manager is used to check the printer available memory, show the files list, delete the files or run the files that saved in the printer DRAM/Flash/Card memory.



Item	Description
DRAM	Use this menu to show, delete and run (.BAS) the files saved in the printer DRAM memory.
FLASH	Use this menu to show, delete and run (.BAS) the files saved in the printer Flash memory.
CARD	Use this menu to show, delete and run (.BAS) the files saved in the SD card on printer. Note: This subsection will only be visible when the SD card installed.

6.8 Diagnostic

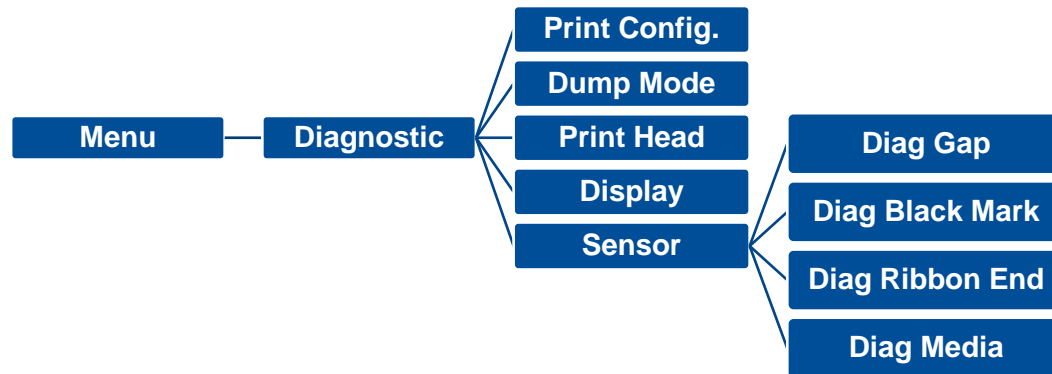

```

DOWNLOA 0D 0A 44 4F 57 4E 4C 4F 4I
D „TEST2. 44 20 22 54 45 53 54 32 2E
DAT“,5,CL 44 41 54 22 2C 35 2C 43 4C
S DOWNLO 53 0D 0A 44 4F 57 4E 4C 4F
AD F,“TES 41 44 20 46 2C 22 54 45 53
T4.DAT“,5 54 34 2E 44 41 54 22 2C 35
,CLS DOW 2C 43 4C 53 0D 0A 44 4F 57
NLOAD „TE 4E 4C 4F 41 44 20 22 54 45
ST2.DAT“, 53 54 32 2E 44 41 54 22 2C
5,CLS DO 35 2C 43 4C 53 0D 0A 44 4F
WNLOAD F, 57 4E 4C 4F 41 44 20 46 2C
„TEST4.DA 22 54 45 53 54 34 2E 44 41
T“,5,CLS 54 22 2C 35 2C 43 4C 53 0D
DOWNLOAD 0A 44 4F 57 4E 4C 4F 41 44
“TEST2.D 20 22 54 45 53 54 32 2E 44
AT“,5,CLS 41 54 22 2C 35 2C 43 4C 53
DOWNLOA 0D 0A 44 4F 57 4E 4C 4F 4I
D F,“TEST 44 20 46 2C 22 54 45 53 54
4.DAT“,5, 34 2E 44 41 54 22 2C 35 2C
CLS 43 4C 53 0D 0A
  
```

Item

Description

Print Config.

Print current printer configuration to the label. The configuration printout contains print head test pattern, which is useful for checking the dot damage on the print head heater.

Dump Mode

Captures the data from the communications port and prints out the data received by printer. In the dump mode, all characters will be printed in 2 columns. The left side characters are received from your system and right side data are the corresponding hexadecimal value of the characters. It allows users or engineers to verify and debug the program.

Dump mode requires 4" wide paper width.

Print Head

Check print head's temperature and bad dots.

Display

Check LCD's color state.

Sensor

Check sensors intensity and reading state.

6.9 Advanced

This feature is used to set the printer LCD settings.



Item	Description
Display Brightness	This item is used to setup the brightness for display.
Date & Time	This item is used to setup the date and time on display.
Language	This item is used to setup the language on display.







6.10 Service

This feature is used to restore printer settings to defaults and checking information for printer.



Item	Description
Initialization	This feature is used to restore printer settings to defaults.
Printer Information	This feature is used to check printer serial number, printed mileage(m), labels(pcs.) and cutting counter.
Contact us	This feature is used to check the contact information for tech support service

7. Troubleshooting

Problem	Possible Cause	Recovery Procedure
 Power indicator does not illuminate	<ul style="list-style-type: none"> * The power cord is not properly connected. 	<ul style="list-style-type: none"> * Plug the power cord in printer and outlet. * Switch the printer on.
 LED turn on (Carriage Open)	<ul style="list-style-type: none"> * The printer head is open. 	<ul style="list-style-type: none"> * Please close the print carriages.
 LED turn on (No Ribbon)	<ul style="list-style-type: none"> * Running out of ribbon. * The ribbon is installed incorrectly. 	<ul style="list-style-type: none"> * Supply a new ribbon roll. * Please refer to the steps on section 3.2 to re-install the ribbon.
 LED Blinking	<ul style="list-style-type: none"> * Ribbon near end 	<ul style="list-style-type: none"> * Supply a new ribbon roll.
 LED turn on (No Paper)	<ul style="list-style-type: none"> * Running out of label. * The label is installed incorrectly. * Gap/black mark sensor is not calibrated. 	<ul style="list-style-type: none"> * Supply a new label roll. * Please refer to the steps on section 3.3 to reinstall the label roll. * Calibrate the gap/black mark sensor.
 LED Blinking (Paper jam)	<ul style="list-style-type: none"> * Gap/black mark sensor is not set properly. * Make sure label size is set properly. * Labels may be stuck inside the printer mechanism. 	<ul style="list-style-type: none"> * Calibrate the media sensor. * Set media size correctly. * Remove the stuck label inside the printer mechanism.
 LED turn on (Other errors)	<ul style="list-style-type: none"> * Out of memory * Print head over heat * Cutter error/ Cutter jam * Check if interface cable is well connected to the interface connector. * Check if wireless or Bluetooth device is well connected between host and printer. * The port specified in the Windows driver is not correct. 	<ul style="list-style-type: none"> * Delete unused files in the FLASH/DRAM. * Wait for print head to cool down. * Remove the stuck label inside the cutter module. * Re-connect cable to interface or change a new cable. * If using serial cable, <ul style="list-style-type: none"> - Please replace the cable with pin to pin connected. - Check the baud rate setting. The default baud rate setting of
Not Printing		

<p>No print on the label</p>	<ul style="list-style-type: none"> * Label or ribbon is loaded not correctly. * Use wrong type paper or ribbon 	<p>printer is 9600,n,8,1.</p> <ul style="list-style-type: none"> * If using the Ethernet cable, <ul style="list-style-type: none"> - Check if the Ethernet RJ-45 connector green LED is lit on. - Check if the Ethernet RJ-45 connector amber LED is blinking. - Check if the printer gets the IP address when using DHCP mode. - Check if the IP address is correct when using the static IP address. - Wait a few seconds let the printer get the communication with the server then check the IP address setting again. * Please reset the wireless device setting. * Select the correct printer port in the driver. * Print head's harness connector is not well connected with printhead. Turn off the printer and plug the connector again. * Check your program if there is a command PRINT at the end of the file and there must have CRLF at the end of each command line. * Follow the instructions in loading the media and ribbon. * Ribbon and media are not compatible. * Verify the ribbon-inked side. * The print density setting is incorrect. * Clean the print head.
<p>Poor Print Quality</p>	<ul style="list-style-type: none"> * Ribbon and media is loaded incorrectly * Dust or adhesive accumulation on the print head. * Print density is not set properly. * Print head element is damaged. * Ribbon and media are incompatible. * The print head pressure is not set properly. 	<ul style="list-style-type: none"> * Reload the supply. * Clean the print head. * Clean the platen roller. * Adjust the print density and print speed. * Run printer self-test and check the print head test pattern if there is dot missing in the pattern. * Change proper ribbon or proper label media. * The release lever does not latch the print head properly.
<p>Take Label</p>	<ul style="list-style-type: none"> * Peel function is enabled. 	<ul style="list-style-type: none"> * If the peeler module is installed, please remove the label. * If there is no peeler module in front of the printer, please switch off the printer and install it. * Check if the connector is plugging correctly.
<p>Cutter is not working</p>	<ul style="list-style-type: none"> * The connector is loose. * Cutter jam. * Cutter PCB is damaged. 	<ul style="list-style-type: none"> * Plug in the connect cable correctly. * Remove the label. * Make sure the thickness of label is less than 0.19 mm.

		* Replace a cutter driver IC board.
Can't downloading the file to memory (FLASH / DRAM/CARD)	* The space of memory is full.	* Delete unused files in the memory.
SD card is unable to use	* SD card is damaged. * SD card doesn't insert correctly. * Use the non-approved SD card manufacturer.	* Use the supported capacity SD card. * Insert the SD card again. * The supported SD card spec and the approved SD card manufacturers, please refer to section 2.2.3.
Missing printing on the left or right side of label	* Wrong label size setup.	* Set the correct label size.
Gray line on the blank label	* The print head is dirty. * The platen roller is dirty.	* Clean the print head. * Clean the platen roller.
Irregular printing	* The printer is in Hex Dump mode. * The RS-232 setting is incorrect.	* Turn off and on the printer to skip the dump mode. * Re-set the Rs-232 setting.
Label feeding is not stable (skew) when printing	* The media guides do not touch the edge of the media.	* If the label is moving to the right side, please move the label guide to left. * If the label is moving to the left side, please move the label guide to right.
Skip labels when printing	* Label size is not specified properly. * Sensor sensitivity is not set properly. * The media sensor is covered with dust. * Printhead pressure is incorrect. * Ribbon installation is incorrect. * Media installation is incorrect. * Print density is incorrect. * Media feeding is incorrect.	* Check if label size is setup correctly. * Calibrate the sensor by Auto Gap or Manual Gap options. * Clear the GAP/Black mark sensor by blower.
Wrinkle Problem		* Please set the suitable density to have good print quality. * Make sure the label guides touch the edge of the media guide.
RTC time is incorrect when reboot the printer	* The battery has run down.	* Check if there is a battery on the main board.
The printing position of small label is incorrect	* Media sensor sensitivity is not set properly. * Label size is incorrect. * The parameter Shift Y is incorrect. * The vertical offset setting in the driver is incorrect.	* Calibrate the sensor sensitivity again. * Set the correct label size and gap size. * Use TSC Console to fine tune the parameter of Shift Y. * If using the software BarTender, please set the vertical offset in the driver.

8. Maintenance

This session presents the clean tools and methods to maintain the printer.

■ For Cleaning

Depending on the media used, the printer may accumulate residues (media dust, adhesives, etc.) as a by-product of normal printing. To maintain the best printing quality, you should remove these residues by cleaning the printer periodically. Regularly clean the print head and supply sensors once change a new media to keep the printer at the optimized performance and extend printer life.

■ For Disinfecting

Sanitize your printer to protect yourself and others and can help prevent the spread of viruses.

■ Important

- Set the printer power switch to O (Off) prior to performing any cleaning or disinfecting tasks. Leave the power cord connected to keep the printer grounded and to reduce the risk of electrostatic damage.
- Do not wear rings or other metallic objects while cleaning any interior area of the printer.
- Use only the cleaning agents recommended in this document. Use of other agents may damage the printer and void its warranty.
- Do not spray or drip liquid cleaning solutions directly into the printer. Apply the solution on a clean lint-free cloth and then apply the dampened cloth to the printer.
- Do not use canned air in the interior of the printer as it can blow dust and debris onto sensors and other critical components.
- Only use a vacuum cleaner with a nozzle and hose that are conductive and grounded to drain off static build up.
- All reference in these procedures for use of isopropyl alcohol requires that a 99% or greater isopropyl alcohol content be used to reduce the risk of moisture corrosion to the printhead.
- Do not touch printhead by hand. If you touch it carelessly, please use 99% Isopropyl alcohol to clean it.
- Always taking personal precaution when using any cleaning agent.

Cleaning Tools

- Cotton swab
- Lint-free cloth
- Brush with soft non-metallic bristles
- Vacuum cleaner
- 75% Ethanol (for disinfecting)
- 99% Isopropyl alcohol (for printhead and platen roller cleaning)
- Genuine printhead cleaning pen
- Mild detergent (without chlorine)

Cleaning Process:

Printer Part	Method	Interval
Print Head	<ol style="list-style-type: none"> I. Always turn off the printer before cleaning the printhead. II. Allow the printhead to cool for at least one minute. III. Use a cotton swab and 99% Isopropyl Alcohol or genuine print head cleaning pen to clean the print head surface. 	Clean the print head when changing a new label roll.
Platen Roller	<ol style="list-style-type: none"> I. Turn off the printer. II. Rotate the platen roller and wipe it thoroughly with the lint-free 99% Isopropyl Alcohol. 	Clean the platen roller when changing a new label roll
Peel Bar	Use the lint-free cloth with 99% Isopropyl Alcohol to wipe it.	As needed
Sensor	Use brush with soft non-metallic bristles or a vacuum cleaner, to remove paper dust. Clean upper and lower media sensors to ensure reliable Top of Form and Paper Out sensing.	Monthly
Exterior	Clean the exterior surfaces with a clean, lint-free cloth (water-dampened cloth). If necessary, use a mild detergent or desktop cleaning solution then use the 75% Ethanol to wipe it.	As needed
Interior	Clean the interior of the printer by removing any dirt and lint with a vacuum cleaner, as described above, or use a brush with soft non-metallic bristles then use the 75% Ethanol to wipe it.	As needed

9. Agency Compliance and Approvals



EN 55022, Class B
EN 55024
EN 60950-1



FCC part 15B, Class B



AS/NZS CISPR 22, Class B



UL 60950-1



EN 60950-1



GB 4943.1
GB 9254
GB 17625.1

Wichtige Sicherheits-Hinweise

1. Bitte lesen Sie diese Hinweis sorgfältig durch.
2. Heben Sie diese Anleitung für den späteren Gebrauch auf.
3. Vor jedem Reinigen ist das Gerät vom Stromnetz zu trennen. Verwenden Sie keine Flüssig-oder Aerosolreiniger. Am besten eignet sich ein angefeuchtetes Tuch zur Reinigung.

4. Die Netzanschluß-Steckdose soll nahe dem Gerät angebracht und leicht zugänglich sein.
5. Das Gerät ist vor Feuchtigkeit zu schützen.
6. Bei der Aufstellung des Gerätes ist auf sicheren Stand zu achten. Ein Kippen oder Fallen könnte Beschädigungen hervorrufen.
7. Beachten Sie beim Anschluß ans Stromnetz die Anschlußwerte.
8. Dieses Gerät kann bis zu einer Außentemperatur von maximal 40°C betrieben werden.

Battery safety warning:

DO NOT throw the battery in fire.

DO NOT short circuit the contacts.

DO NOT disassemble the battery.

DO NOT throw the battery in municipal waste.

The symbol of the crossed out wheeled bin indicates that the battery should not be placed in municipal waste.

CAUTION

Risk of explosion if battery is replaced by an incorrect type.

Dispose of used batteries according to the instructions.

“VORSICHT”

Explosionsgefahr bei unsachgemäßen Austausch der Batterie. Ersatz nur durch denselben oder einem vom Hersteller empfohlenem ähnlichen Typ. Entsorgung gebrauchter Batterien nach Angaben des Herstellers.

FCC STATEMENT :

This equipment has been tested and found to comply with the limits for a Class B digital device, pursuant to part 15 of the FCC Rules. These limits are designed to provide reasonable protection against harmful interference in a residential installation. This equipment generates, uses and can radiate radio frequency energy and, if not installed and used in accordance with the instructions, may cause harmful interference to radio communications. However, there is no guarantee that interference will not occur in a particular installation. If this equipment does cause harmful interference to radio or television reception, which can be determined by turning the equipment off and on, the user is encouraged to try to correct the interference by one or more of the following measures:

-Reorient or relocate the receiving antenna.

-Increase the separation between the equipment and receiver.

-Connect the equipment into an outlet on a circuit different from that to which the receiver is connected.

-Consult the dealer or an experienced radio/ TV technician for help.

This device complies with Part 15 of the FCC Rules. Operation is subject to the following two conditions: (1) This device may cause harmful interference, and (2) this device must accept any interference received, including interference that may cause undesired operation.

This Class B digital apparatus complies with Canadian ICES-003

Cet appareil numérique de la classe B est conforme à la norme NMB-003 du Canada.

CAUTION:

Any changes or modifications not expressly approved by the grantee of this device could void the user's authority to operate the equipment.

CAUTION :

HAZARDOUS MOVING PARTS, KEEP FINGER AND OTHER BODY PARTS AWAY.

10. Revise History

Date

Content

Editor

TSC **PRINTRONIX**[®]
AUTO ID