

CipherLab Reference Manual

RS30 Mobile Computer
Android 4.4.2

Version 1.00



Copyright © 2015 CIPHERLAB CO., LTD.
All rights reserved

The software is provided under a license agreement containing restrictions on use and disclosure and is also protected by copyright law. Reverse engineering of the software is prohibited.

Due to continued product development this information may change without notice. The information and intellectual property contained herein is confidential between CIPHERLAB and the client and remains the exclusive property of CIPHERLAB CO., LTD. If you find any problems in the documentation, please report them to us in writing. CIPHERLAB does not warrant that this document is error-free.

No part of this publication may be reproduced, stored in a retrieval system, or transmitted in any form or by any means, electronic, mechanical, photocopying, recording or otherwise without the prior written permission of CIPHERLAB CO., LTD.

For product consultancy and technical support, please contact your local sales representative. Also, you may visit our web site for more information.

The CipherLab logo is a registered trademark of CIPHERLAB CO., LTD.

All brand, product and service, and trademark names are the property of their registered owners.

The editorial use of these names is for identification as well as to the benefit of the owners, with no intention of infringement.

CIPHERLAB CO., LTD.

Website: <http://www.CipherLab.com>

IMPORTANT NOTICES

FOR USA

This equipment has been tested and found to comply with the limits for a **Class B** digital device, pursuant to Part 15 of the FCC Rules. These limits are designed to provide reasonable protection against harmful interference in a residential installation. This equipment generates, uses and can radiate radio frequency energy and, if not installed and used in accordance with the instructions, may cause harmful interference to radio communication. However, there is no guarantee that interference will not occur in a particular installation. If this equipment does cause harmful interference to radio or television reception, which can be determined by turning the equipment off and on, the user is encouraged to try to correct the interference by one or more of the following measures:

- ▶ Reorient or relocate the receiving antenna.
- ▶ Increase the separation between the equipment and receiver.
- ▶ Connect the equipment into an outlet on a circuit different from that to which the receiver is connected.
- ▶ Consult the dealer or an experienced radio/TV technician for help.

This device complies with Part 15 of the FCC Rules. Operation is subject to the following two conditions: (1) This device may not cause harmful interference, and (2) this device must accept any interference received, including interference that may cause undesired operation.

FCC Caution:

Any changes or modifications not expressly approved by the party responsible for compliance could void the user's authority to operate this equipment.

FOR PRODUCT WITH LASER

CAUTION



This laser component emits FDA / IEC Class 2 laser light at the exit port. Do not stare into beam.

SPECIFIC ABSORPTION RATE (SAR) INFORMATION

The product complies with the FCC / Canada portable RF exposure limit set forth for an uncontrolled environment and are safe for intended operation as described in this manual. The further RF exposure reduction can be achieved if the products can be kept as far as possible from the user body or set the device to lower output power if such function is available.

1. FCC SAR Value (Standard limit is 1.6 W/Kg)

USA (1g): Max. 0.9 W/Kg

2. CE SAR Value (Standard limit is 2 W/Kg)

CE (10g): Max. 0.339 W/Kg

SAFETY PRECAUTIONS

RISK OF EXPLOSION IF BATTERY IS REPLACED BY AN INCORRECT TYPE. DISPOSE OF USED BATTERIES ACCORDING TO THE INSTRUCTIONS.

- ▶ The use of any batteries or charging devices, which are not originally sold or manufactured by CipherLab, will void your warranty and may cause damage to human body or the product itself.
- ▶ DO NOT disassemble, incinerate or short circuit the battery.
- ▶ DO NOT expose the device or the battery to any flammable sources.
- ▶ For green-environment issue, it's important that batteries should be recycled in a proper way.



To prevent possible hearing damage, do not listen at high volume levels for long periods.

CARE & MAINTENANCE

- ▶ This mobile computer is intended for industrial use. The mobile computer is rated IP54, however, damage may be done to the mobile computer if it is exposed to extreme temperatures or soaked in water.
- ▶ When the body of the mobile computer gets dirty, use a clean, wet cloth to wipe off dust and debris. DO NOT use bleaches or cleaners.
- ▶ Use a clean, non-abrasive, lint-free cloth to wipe dust off the LCD touch screen. DO NOT use any pointed or sharp objects against the surface. Always keep the LCD dry.

- ▶ If you want to put away the mobile computer for a period of time, download the collected data to a host computer, and then remove the battery pack from the mobile computer's battery compartment. Store the mobile computer and battery pack separately.
- ▶ If you encounter malfunction on the mobile computer, write down the specific scenario and consult your local sales representative.

EUROPE - EU DECLARATION OF CONFORMITY

This device complies with the essential requirements of the R&TTE Directive 1999/5/EC. The following test methods have been applied in order to prove presumption of conformity with the essential requirements of the R&TTE Directive 1999/5/EC:

- ▶ EN 60950-1: 2001
- ▶ EN 60950-1/A1: 2010
- ▶ EN 60950-1/A11: 2009
- ▶ EN 60950-1/A12: 2011
Safety of Information Technology Equipment
- ▶ EN 62479:2010
Assessment of the compliance of low power electronic and electrical equipment with the basic restrictions related to human exposure to electromagnetic fields (10 MHz to 300 GHz)
- ▶ EN 62311: 2008 / Article 3(1)(a) and Article 2 2006/95/EC
Assessment of electronic and electrical equipment related to human exposure restrictions for electromagnetic fields (0 Hz-300 GHz) (IEC 62311:2007 (Modified))
- ▶ EN 50360: 2001+A1: 2012
Product standard to demonstrate the compliance of mobile phones with the basic restrictions related to human exposure to electromagnetic fields (300 MHz - 3 GHz)
- ▶ EN 62209-1: 2006
Human exposure to radio frequency fields from hand-held and body-mounted wireless communication devices – Human models, instrumentation, and procedures –
Part 1: Procedure to determine the specific absorption rate (SAR) for hand-held devices used in close proximity to the ear (frequency range of 300 MHz to 3 GHz).
- ▶ EN 62209-2: 2010
Human exposure to radio frequency fields from handheld and bodymounted wireless communication devices — Human models, instrumentation, and procedures
- ▶ EN 300 330-2 V1.5.1: 2006
Electromagnetic compatibility and Radio spectrum Matters (ERM); Short Range Devices (SRD); Radio equipment in the frequency range 9 kHz to 25 MHz and inductive loop systems in the frequency range 9 kHz to 30 MHz; Part 1: Technical characteristics and test methods.
- ▶ EN 300 330-1 V1.7.1: 2010
Electromagnetic compatibility and Radio spectrum Matters (ERM); Short Range Devices (SRD); Radio equipment in the frequency range 9 kHz to 25 MHz and inductive loop systems in the frequency range 9 kHz to 30 MHz; Part 1: Technical characteristics and test methods.
- ▶ EN 300 440-1 V1.6.1: 2010
Electromagnetic compatibility and Radio spectrum Matters (ERM); Short range devices; Radio equipment to be used in the 1 GHz to 40 GHz frequency range; Part1: Technical characteristics and test methods.

- ▶ EN 300 440-2 V1.4.1: 2010
Electromagnetic compatibility and Radio spectrum Matters (ERM); Short range devices; Radio equipment to be used in the 1 GHz to 40 GHz frequency range; Part 2: Harmonized EN under article 3.2 of the R&TTE Directive.
- ▶ EN 300 328 V1.7.1: 2006
Electromagnetic compatibility and Radio spectrum Matters (ERM); Wideband Transmission systems; Data transmission equipment operating in the 2,4 GHz ISM band and using spread spectrum modulation techniques; Harmonized EN covering essential requirements under article 3.2 of the R&TTE Directive.
- ▶ EN 301 893 V1.6.1: 2011
Broadband Radio Access Networks (BRAN); 5 GHz high performance RLAN; Harmonized EN covering essential requirements of article 3.2 of the R&TTE Directive.
- ▶ EN 301 908-1 V5.2.1: 2011
Electromagnetic compatibility and Radio spectrum Matters (ERM); Base Stations (BS), Repeaters and User Equipment (UE) for IMT-2000 Third-Generation cellular networks; Part 1: Harmonized EN for IMT-2000, introduction and common requirements, covering essential requirements of article 3.2 of the R&TTE Directive.
- ▶ EN 301 511 V9.0.2: 2003
Global System for Mobile communications (GSM); Harmonized standard for mobile stations in the GSM 900 and DCS 1800 bands covering essential requirements under article 3.2 of the R&TTE directive (1999/5/EC).
- ▶ EN 301 489-1 V1.9.2: 2008
Electromagnetic compatibility and Radio Spectrum Matters (ERM); ElectroMagnetic Compatibility (EMC) standard for radio equipment and services; Part 1: Common technical requirements.
- ▶ EN 301 489-3 V1.4.1 2002
Electromagnetic compatibility and Radio Spectrum Matters (ERM); ElectroMagnetic Compatibility (EMC) standard for radio equipment and services; Part 3: Specific conditions for Short-Range Devices (SRD) operating on frequencies between 9 kHz and 40 GHz.
- ▶ EN 301 489-7 V1.3.1: 2005
ElectroMagnetic compatibility and Radio spectrum Matters (ERM); ElectroMagnetic Compatibility (EMC) standard for radio equipment ad services; Part 7: Specific conditions for mobile and portable radio and ancillary equipment of digital cellular radio telecommunications systems (GSM and DCS).
- ▶ EN 301 489-17 V2.2.1: 2012
Electromagnetic compatibility and Radio spectrum Matters (ERM); ElectroMagnetic Compatibility (EMC) standard for radio equipment and services; Part 17: Specific conditions for 2,4 GHz wideband transmission systems and 5 GHz high performance RLAN equipment.
- ▶ EN 301 489-24 V1.5.1: 2010
Electromagnetic compatibility and Radio Spectrum Matters (ERM); ElectroMagnetic Compatibility (EMC) standard for radio equipment and services; Part 24: Specific conditions for IMT-2000 CDMA Direct Spread (UTRA) for Mobile and portable (UE) radio and ancillary equipment.

CE 0560 !

cs Český [Czech]	<i>[Jméno výrobce]</i> tímto prohlašuje, že tento <i>[typ zařízení]</i> je ve shodě se základními požadavky a dalšími příslušnými ustanoveními směrnice 1999/5/ES.
da Dansk [Danish]	Undertegnede <i>[fabrikantens navn]</i> erklærer herved, at følgende udstyr <i>[udstyrets typebetegnelse]</i> overholder de væsentlige krav og øvrige relevante krav i direktiv 1999/5/EF.
de Deutsch [German]	Hiermit erkläre <i>[Name des Herstellers]</i> , dass sich das Gerät <i>[Gerätetyp]</i> in Übereinstimmung mit den grundlegenden Anforderungen und den übrigen einschlägigen Bestimmungen der Richtlinie 1999/5/EG befindet.
et Eesti [Estonian]	Käesolevaga kinnitab <i>[tootja nimi = name of manufacturer]</i> seadme <i>[seadme tüüp = type of equipment]</i> vastavust direktiivi 1999/5/EÜ põhinõuetele ja nimetatud direktiivist tulenevatele teistele asjakohastele sätetele.
en English	Hereby, <i>[name of manufacturer]</i> , declares that this <i>[type of equipment]</i> is in compliance with the essential requirements and other relevant provisions of Directive 1999/5/EC.
es Español [Spanish]	Por medio de la presente <i>[nombre del fabricante]</i> declara que el <i>[clase de equipo]</i> cumple con los requisitos esenciales y cualesquiera otras disposiciones aplicables o exigibles de la Directiva 1999/5/CE.
el Ελληνική [Greek]	ΜΕ ΤΗΝ ΠΑΡΟΥΣΑ <i>[name of manufacturer]</i> ΔΗΛΩΝΕΙ ΟΤΙ <i>[type of equipment]</i> ΣΥΜΜΟΡΦΩΝΕΤΑΙ ΠΡΟΣ ΤΙΣ ΟΥΣΙΩΔΕΙΣ ΑΠΑΙΤΗΣΕΙΣ ΚΑΙ ΤΙΣ ΛΟΙΠΕΣ ΣΧΕΤΙΚΕΣ ΔΙΑΤΑΞΕΙΣ ΤΗΣ ΟΔΗΓΙΑΣ 1999/5/ΕΚ.
fr Français [French]	Par la présente <i>[nom du fabricant]</i> déclare que l'appareil <i>[type d'appareil]</i> est conforme aux exigences essentielles et aux autres dispositions pertinentes de la directive 1999/5/CE.
it Italiano [Italian]	Con la presente <i>[nome del costruttore]</i> dichiara che questo <i>[tipo di apparecchio]</i> è conforme ai requisiti essenziali ed alle altre disposizioni pertinenti stabilite dalla direttiva 1999/5/CE.
Latviski [Latvian]	Ar šo <i>[name of manufacturer / izgatavotāja nosaukums]</i> deklarē, ka <i>[type of equipment / iekārtas tips]</i> atbilst Direktīvas 1999/5/EK būtiskajām prasībām un citiem ar to saistītajiem noteikumiem.
Lietuvių [Lithuanian]	Šiuo <i>[manufacturer name]</i> deklaruojama, kad šis <i>[equipment type]</i> atitinka esminius reikalavimus ir kitas 1999/5/EB Direktyvos nuostatas.
nl Nederlands [Dutch]	Hierbij verklaart <i>[naam van de fabrikant]</i> dat het toestel <i>[type van toestel]</i> in overeenstemming is met de essentiële eisen en de andere relevante bepalingen van richtlijn 1999/5/EG.
mt Malti [Maltese]	Hawnhekk, <i>[isem tal-manifattur]</i> , jiddikjara li dan <i>[il-mudell tal-prodott]</i> jikkonforma mal-htigijiet essenzjali u ma provvedimenti oħrajn relevanti li hemm fid-Dirrettiva 1999/5/EC.
hu Magyar [Hungarian]	Alulírott, <i>[gyártó neve]</i> nyilatkozom, hogy a <i>[... típus]</i> megfelel a vonatkozó alapvető követelményeknek és az 1999/5/EC irányelv egyéb előírásainak.
pl Polski [Polish]	Niniejszym <i>[nazwa producenta]</i> oświadczam, że <i>[nazwa wyrobu]</i> jest zgodny z zasadniczymi wymogami oraz pozostałymi stosownymi postanowieniami Dyrektywy 1999/5/EC.
pt Português [Portuguese]	<i>[Nome do fabricante]</i> declara que este <i>[tipo de equipamento]</i> está conforme com os requisitos essenciais e outras disposições da Directiva 1999/5/CE.
sl Slovensko [Slovenian]	<i>[Ime proizvajalca]</i> izjavlja, da je ta <i>[tip opreme]</i> v skladu z bistvenimi zahtevami in ostalimi relevantnimi določili direktive 1999/5/ES.
Slovensky [Slovak]	<i>[Meno výrobcu]</i> týmto vyhlasuje, že <i>[typ zariadenia]</i> spĺňa základné požiadavky a všetky príslušné ustanovenia Smernice 1999/5/ES.
fi Suomi [Finnish]	<i>[Valmistaja = manufacturer]</i> vakuuttaa täten että <i>[type of equipment = laitteen tyyppimerkintä]</i> tyyppinen laite on direktiivin 1999/5/EY oleellisten vaatimusten ja sitä koskevien direktiivin muiden ehtojen mukainen.
sv Svenska [Swedish]	Härmed intygar <i>[företag]</i> att denna <i>[utrustningstyp]</i> står i överensstämmelse med de väsentliga egenskapskrav och övriga relevanta bestämmelser som framgår av direktiv 1999/5/EG.

RELEASE NOTES

Version	Date	Notes
1.00	May 7, 2015	▶ Initial release

CONTENTS

IMPORTANT NOTICES	- 3 -
For USA	- 3 -
For Product with Laser	- 4 -
Specific Absorption Rate (SAR) information	- 4 -
Safety Precautions	- 4 -
Care & Maintenance	- 4 -
EUROPE - EU Declaration of Conformity	- 6 -
RELEASE NOTES	- 9 -
INTRODUCTION	1
Features	2
Inside the Package	2
Accessories	2
QUICK START	5
1.1. Overview	5
1.1.1. Installing Battery	7
1.1.2. Installing SIM Card, SAM Card and Memory Card	8
1.1.3. Installing Hardshell	10
1.1.4. Power On/Off Mobile Computer	10
1.1.5. Using Hardware Buttons	11
1.1.6. Connecting Headset	11
1.2. Charging & Communication	12
1.2.1. Charge Mobile Computer	12
1.2.2. Wired Data Transmission	15
1.2.3. Using Wireless Networks	15
USING THE RS30 MOBILE COMPUTER	17
2.1. Battery	18
2.1.1. Battery Status Indicators	19
2.1.2. Monitor Battery Level	20
2.1.3. Replace Main Battery	22
2.1.4. Power Management	23
2.2. Memory	24
2.2.1. Check Storage Space	25
2.3. Touch Screen	26
2.3.1. Screen Brightness	26
2.3.2. Screen Rotation	26
2.3.3. Screen Timeout Settings	27
2.3.4. Text Size	28
2.4. Notifications	29
2.4.1. Status LED	29
2.4.2. Audio	29
2.4.3. Vibrator	29
2.5. Date and Time	31
2.5.1. Set Date, Time and Time Zone	31

2.6.	Language & Keyboard Input	32
2.6.1.	On-screen Keyboard	32
2.7.	Sound and Volume	33
2.8.	Programmable Keys	34
2.9.	Data Capture.....	38
2.9.1.	Barcode Reader.....	38
2.9.2.	Digital Camera	38
2.10.	Snap-on USB Charging Cable.....	39
2.11.	Charging Cradle	40
BASIC OPERATION		41
3.1.	Home Screen	42
3.1.1.	Customize Home Screen.....	44
3.1.2.	Customize Wallpaper.....	46
3.2.	Widgets.....	47
3.2.1.	Add Widgets	48
3.2.2.	Remove Widgets.....	49
3.3.	Status Bar	50
3.4.	Notifications Panel	53
3.5.	Applications Menu	55
3.6.	Manage Applications.....	57
3.6.1.	Current Applications	57
3.7.	Suspend & Lock.....	58
3.7.1.	Suspend Device.....	58
3.7.2.	Lock Device.....	58
3.8.	OS Update	59
WIRELESS RADIOS.....		67
4.1.	Use Wireless Wide Area Network	68
4.1.1.	Share WWAN Data.....	69
4.1.2.	Data Usage.....	70
4.1.3.	Data Connection Settings	71
4.1.4.	SIM Card Settings.....	72
4.2.	Use Wireless Local Area Network (Wi-Fi)	73
4.2.1.	Power On/Off Wi-Fi	73
4.2.2.	Connect to Wi-Fi Network.....	74
4.2.3.	Manually Add Wi-Fi Network	76
4.2.4.	Advanced Wi-Fi Settings.....	77
4.2.5.	Configure Proxy Server	78
4.2.6.	Use Static IP Address	78
4.2.7.	Connect With Wi-Fi Protected Setup (WPS)	78
4.2.8.	Modify Wi-Fi Network.....	78
4.2.9.	Disconnect Wi-Fi Network	79
4.3.	Use Bluetooth	80
4.3.1.	Bluetooth Profiles	80
4.3.2.	Power On/Off Bluetooth	81
4.3.3.	Set Bluetooth Visibility.....	82
4.3.4.	Change Bluetooth Name.....	83
4.3.5.	Pair Bluetooth Device.....	83
4.3.6.	Unpair Bluetooth Device	84

4.3.7.	Select Bluetooth Service	84
4.4.	Use Near Field Communications	85
USING THE PHONE.....		89
5.1.	Phone Power	90
5.1.1.	Turn On/Off Phone Power	91
5.1.2.	SIM Card Missing.....	91
5.2.	Phone Application.....	92
5.2.1.	Phone Interface	92
5.2.2.	Place Call.....	94
5.2.3.	Receive Incoming Call	95
5.2.4.	Check Missed Calls	96
5.2.5.	View Call History	97
5.2.6.	Make Multi-Party Calls.....	98
5.2.7.	Audio Modes	99
5.2.8.	In-call Volume	99
5.2.9.	Phone Settings.....	100
USING READER CONFIGURATION UTILITY		103
6.1.	Configure Reader.....	104
6.1.1.	General Settings	105
6.1.2.	Symbology	113
6.1.3.	Miscellaneous.....	117
6.1.4.	Reader Config Option Menu.....	118
6.2.	Read Printed Barcodes	124
SPECIFICATIONS		127
	Platform, Processor & Memory.....	127
	Communication & Data Capture	127
	Electrical Characteristics	128
	Physical Characteristics	129
	Environmental Characteristics	130
	Programming Support.....	130
	Accessories.....	131
SCAN ENGINE SETTINGS		132
	Symbologies Supported	133
CCD (SM1)		136
	Symbology Settings	136
LASER (SE955)		142
	Symbology Settings	142
	Miscellaneous	147
	AIM Code ID – Code Characters.....	148
	AIM Code ID – Modifier Characters.....	148
2D IMAGER (SE4500DL)		152
	Symbology Settings	152
	1D Symbologies	152
	2D Symbologies	161
	Miscellaneous	162

INTRODUCTION

The RS30 Mobile Computer, powered by Android 4.4.2, is light-weight, easy to use, and provides more powerful and handy tools to delivering flexibility in customization.

Specifically designed to work as an industrial PDA, the RS30 Mobile Computer provides rich options of data collection, voice and data communication, long-lasting working hours, and so on. Its large color transmissive display guarantees ease in reading in all lighting conditions. Integrated with Bluetooth v4.0, v2.1+EDR and 802.11b/g/n technologies, the mobile computer also includes a GSM/GPRS/EDGE/WCDMA/UMTS/HSDPA/HSUPA/HSPA+ module to gain greater speeds and optimal mobility. In particular, an integrated GPS receiver is made available for use with third-party location-based applications.

This manual serves to guide you through how to install, configure, and operate the mobile computer. The Care & Maintenance section is specifically crucial for those who are in charge of taking care of the mobile computer.

We recommend you to keep one copy of the manual at hand for quick reference or maintenance purposes. To avoid any improper disposal or operation, please read the manual thoroughly before use.

Thank you for choosing CipherLab products!

FEATURES

- ▶ Built tough to survive drop test and sealed against moisture/dust to industrial standard IP54
- ▶ Android 4.4.2 operating system with a powerful Cortex 1.3 GHz Quad-Core processor
- ▶ 8GB eMMC flash memory to store OS and software programs
- ▶ 1GB LPDDR2 RAM to store and run programs, as well as store program data
- ▶ One expansion slot for microSDHC memory card up to 32GB, SDXC supported
- ▶ Three reader options — 1D linear, 1D laser or 2D imager
- ▶ Built-in 8.0 Megapixel CMOS digital camera with white LED for flash and auto focus
- ▶ Left and right side triggers for ambidextrous scanning
- ▶ Total wireless solution — connectivity includes Bluetooth v4.0 and v2.1+EDR, 802.11b/g/n, GSM/GPRS/EDGE/WCDMA/UMTS/HSDPA/HSUPA/HSPA+, and near field communication (NFC)
- ▶ A 4.7" color transmissive display with 960x540 pixels to deliver excellent visibility in all lighting conditions
- ▶ Configurable feedback indicators including speaker and vibrator
- ▶ Built-in scan engine setting tool Reader Configuration which serves out-of-the-box keyboard wedge functionality
- ▶ Accessories and peripherals include USB Charging and Data Transfer Cable, Snap-on USB Charging Cable and Charging Cradle

INSIDE THE PACKAGE

The following items are included in the kit package. Save the box and packaging material for future use in case you need to store or ship the mobile computer.

- ▶ RS30 Mobile Computer
- ▶ Rechargeable Li-ion battery pack
- ▶ Wrist Band
- ▶ Micro USB Charging and Data Transfer Cable
- ▶ Snap-on USB Charging Cable
- ▶ AC Power Adaptor
- ▶ Quick Guide

ACCESSORIES

- ▶ Hardshell
- ▶ Charging Cradle

RELATED DOCUMENTATION

Log in to GoBetween to access related documentation about the RS30 mobile computer from the CipherLab Central Service (CCS) platform. Download the GoBetween desktop or mobile device application, or launch the GoBetween Lite web application from the following site: <http://ccs.cipherlab.com/>.

QUICK START

1.1. OVERVIEW

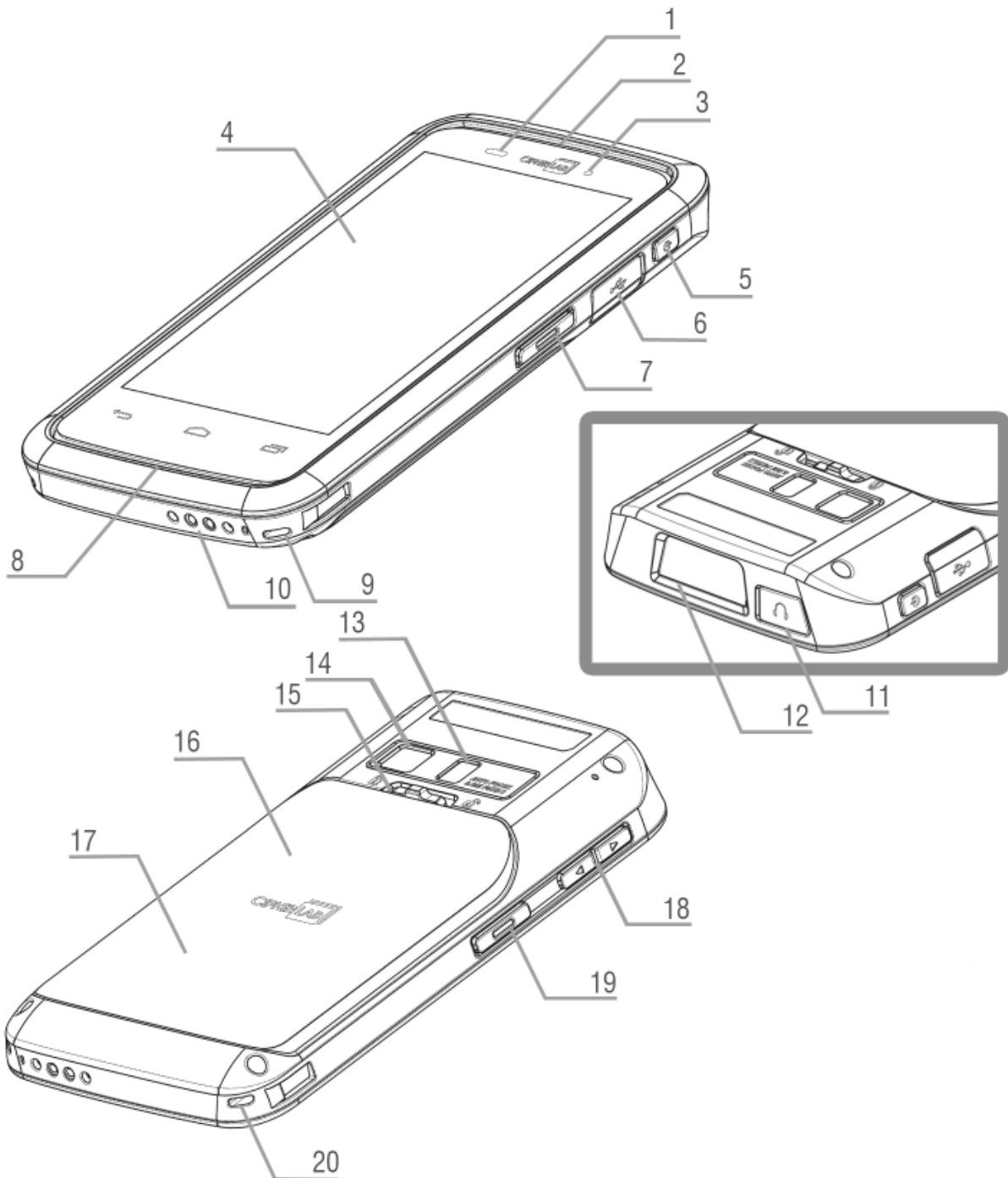

No.	Description	No.	Description
1	Proximity+ALS Sensor Hole	2	Receiver
3	Status LED	4	Touchscreen
5	Power Button	6	Micro USB Port
7	Side Key	8	Speaker
9	Wristband Slot	10	Charging Pins
11	Headset Jack	12	Scan Window
13	Camera Flash	14	Camera
15	Battery Cover Latch	16	Battery Cover
17	NFC Detection Area	18	Volume Buttons
19	Side Key	20	Wristband Slot

1.1.1. INSTALLING BATTERY

For shipping and storage purposes, the mobile computer and the main battery are saved in separate packages.

Note: Any improper handling may reduce the battery life.

To install the main battery:

- 1) Push the battery lock at the top of the battery cover to the right in order to unlock.
- 2) The battery cover will open automatically.
- 3) Insert the main battery with the contact pins facing the lower end. Fix the top edge of the battery first.
- 4) Press down the lower edge of the battery.
- 5) Fix the lower edge of the battery cover, then push the upper end in.
- 6) Push the battery lock to the left to lock.

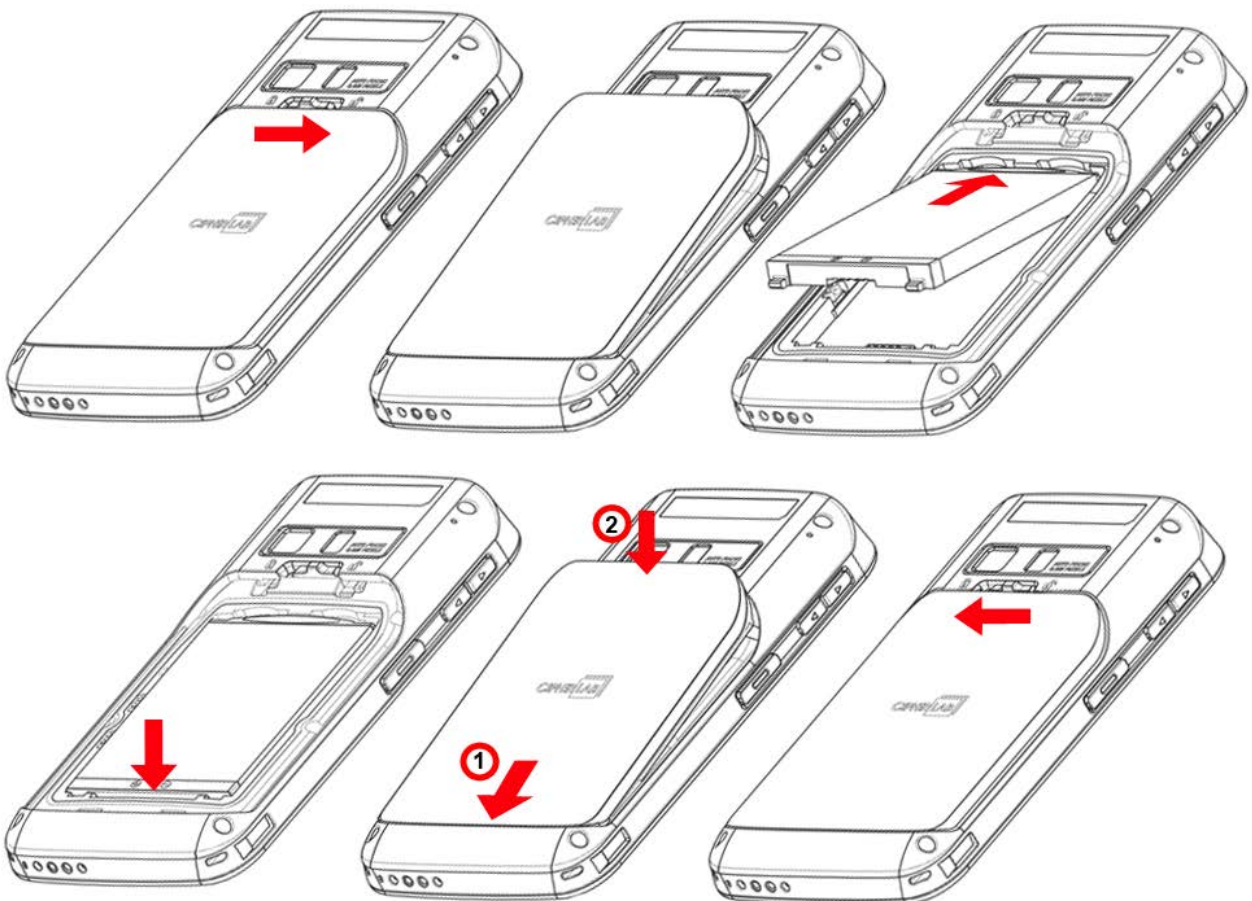

Warning:

- (1) Check that the battery lock is at the "lock" position before powering on the device.
- (2) For initial use, insert a charged battery, lock the battery cover in place, then press the Power key to power on the mobile computer.

Remove Battery

- 1) Unlock the battery lock and remove the battery cover.
- 2) Lift the battery up from its lower end.
- 3) Replace the battery cover and push the battery lock to the left.

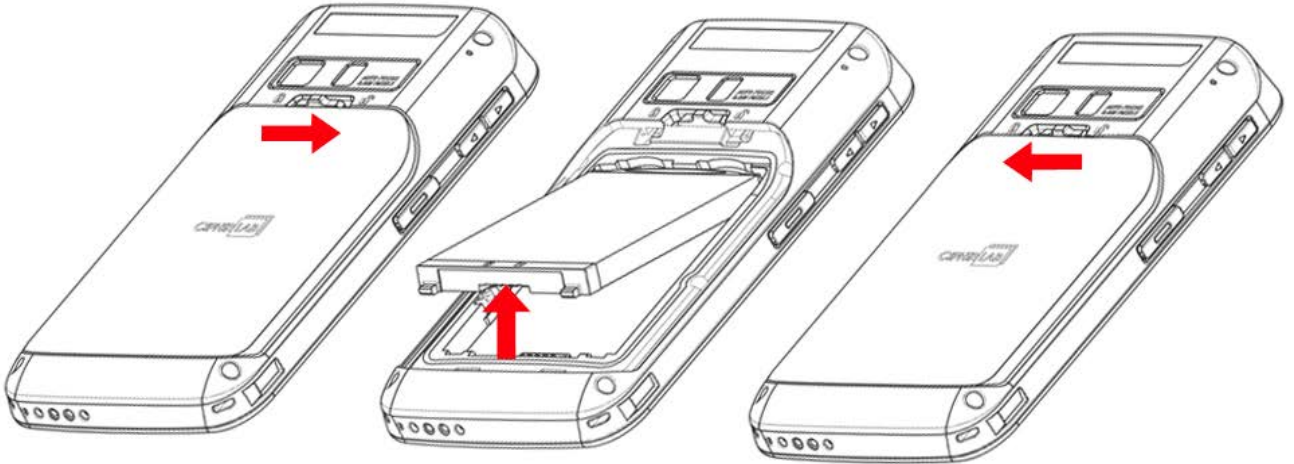

1.1.2. INSTALLING SIM CARD, SAM CARD AND MEMORY CARD

The RS30 Mobile Computer is equipped with two SIM card slots, one SAM card slot and one memory card slot.

To insert the cards:

- 1) Remove the battery cover as described in steps 1-3 of [Installing Battery](#).
- 2) Insert the cards into their respective slots according to the directions indicated. Push the cards to lock them in.

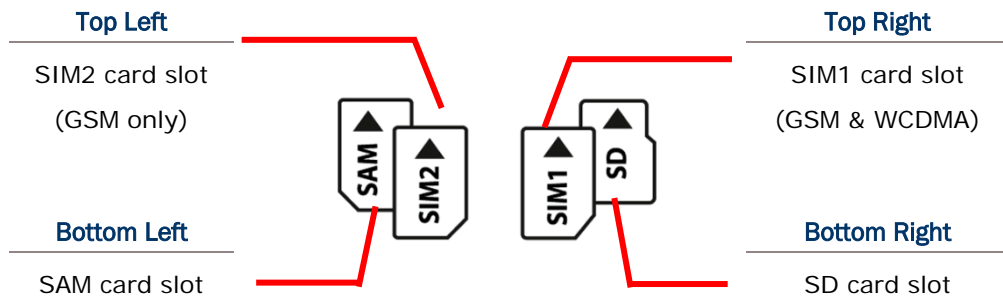

The SIM 1 slot (on the right) supports both 2G and 3G networks, while the SIM 2 slot (on the left) supports only 2G networks. See [Data Connection Settings](#) for how to configure 2G and 3G networks.

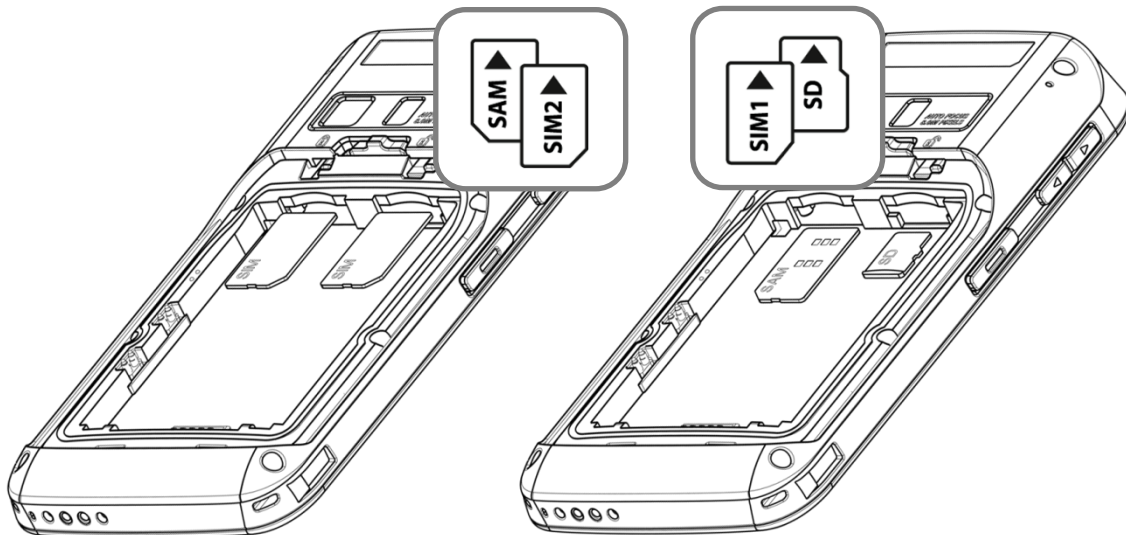

- 3) Replace the battery cover and push the battery lock back to the lock position.

Remove Cards

- 1) Remove the battery cover as described in steps 1-3 of [Installing Battery](#).
- 2) Push the SIM cards, SAM card and SD card to eject them from their slots.
- 3) Replace the battery cover and push the battery lock back to the lock position.

1.1.3. INSTALLING HARDSHELL

The Hardshell is a protective cover that shields the mobile computer from impact due to bumps, drops and scratches.

To fit the mobile computer in the Hardshell:

- 1) Fix the upper end of the mobile computer in at a 45 degree angle.
- 2) Press the two lower corners of the mobile computer down to secure it inside the shell.

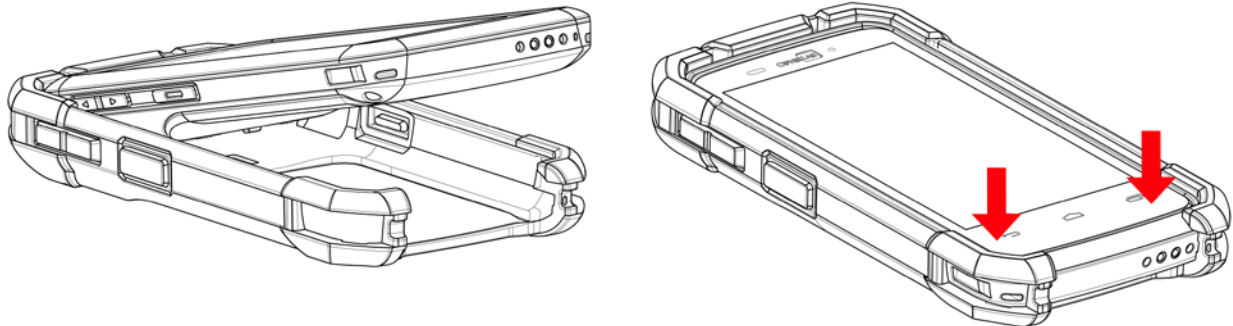

1.1.4. POWER ON/OFF MOBILE COMPUTER

POWER ON

To power on the mobile computer, press and hold the power button  located on the upper right side of the device. The mobile computer opens to show the [Home Screen](#).

Note: For the mobile computer to power on, the battery cover must be secured in place.

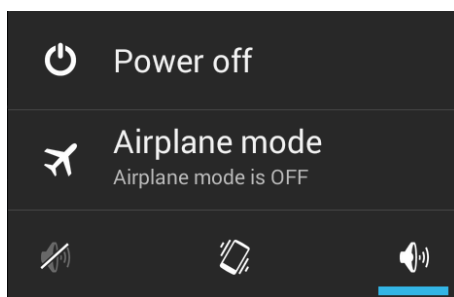

POWER OFF

To power off the mobile computer, press and hold the power button  for more than three seconds. A menu will appear on-screen which allows you to power off the device, switch to airplane mode, or set the system sound to mute or vibrate only. Make sure all user data and tasks have been stored before tapping **Power off**.



1.1.5. USING HARDWARE BUTTONS

On the bottom of the mobile computer are three hardware buttons that deliver the following functions:

Button	Function	Description
	Back button	Returns to the previous screen or closes the active window or keyboard.
	Home button	Displays the Home screen. Tap and hold the Home button to open a list of recently used applications.
	Recent apps button	Opens a list of recently used applications.

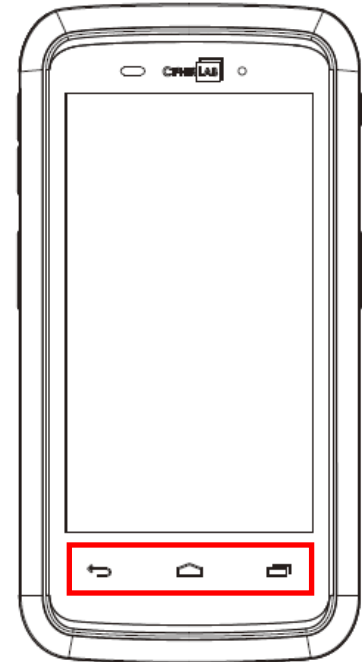

1.1.6. CONNECTING HEADSET

The headset jack is located on the top of the mobile computer. You can use the headset for audio playback or communication via the phone application, audio instant messaging, etc.

- 1) Flip up the rubber cover.
- 2) Connect the headset to the headset jack.
- 3) Replace the rubber cover.

1.2. CHARGING & COMMUNICATION

1.2.1. CHARGE MOBILE COMPUTER

The main battery may not be charged to full for shipment. When you first receive the kit package, you will need to charge the main battery to full before using the mobile computer. You may use the Snap-on USB Charging Cable or Charging Cradle along with a power adapter to charge the mobile computer.

Charging Time

- ▶ Main battery: The main battery powers the mobile computer to work. It takes approximately 4 hours to charge an empty main battery to full. The charging LED above the screen (located on the right) will light up in red while charging and will turn green when charging is complete.
- ▶ When the main battery is removed, RTC retention will be maintained for at least 30 minutes.
- ▶ Backup battery: The backup battery is mounted on the main board. Its role is to temporarily keep the mobile computer in suspension when the main battery is drained out so data in DRAM will be retained. The backup battery takes approximately 3.5 hours to charge to full by the main battery or power adapter.

Charging Temperature

- ▶ It is recommended to charge the battery at room temperature (18°C to 25°C) for optimal performance.
- ▶ Battery charging stops when ambient temperature drops below 0°C or exceeds 40°C.

Operation on Battery Power

- ▶ When 802.11b/g/n, GSM/GPRS/EDGE/WCDMA/UMTS/HSDPA/HSUPA/HSPA+, Bluetooth v4.0 & v2.1+EDR and GPS are all enabled on battery power, the main battery level will drop down substantially. Prolonged use of the display and continued scanning of barcodes will also affect battery level.
- ▶ In order to prevent system shut down after the battery is drained out, we suggest that you keep a fresh battery for replacement at all times, or connect the mobile computer to an external power.

USE SNAP-ON USB CHARGING CABLE

- 1) Fasten the Snap-on USB Charging Cable to the lower end of the mobile computer.
- 2) Connect the other end of the cable to the adapter.
- 3) Fix the adapter plug onto the adapter, and plug in into an electrical outlet.

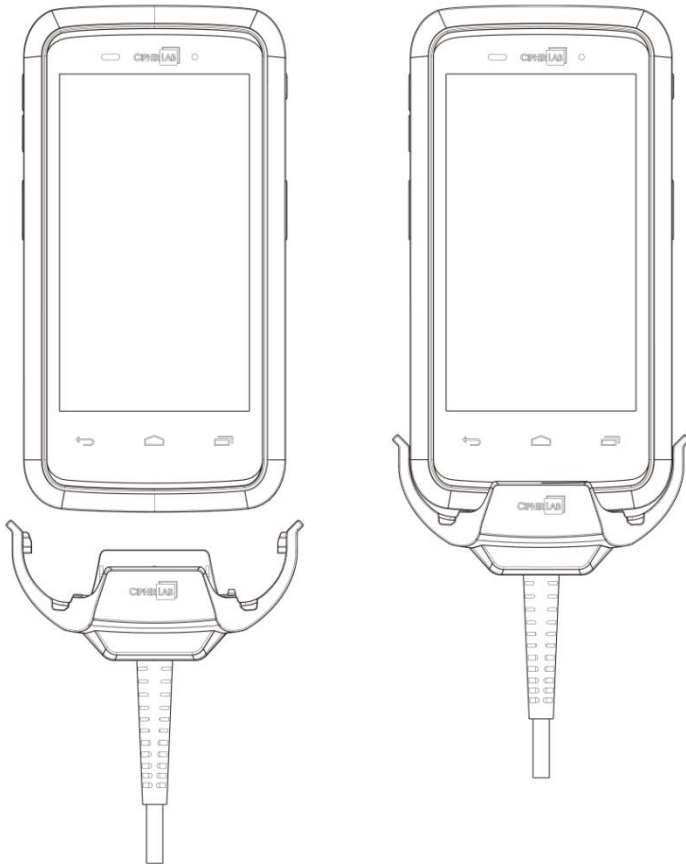

RS30 LED Indicator	Status	Description
Charging	Red, solid	Charging the mobile computer
	Red, blink	Charging error
	Green, solid	Charging complete
	No light	Charging error (charging will stop)

USE CHARGING CRADLE

- 1) Insert the mobile computer onto the Charging Cradle. Press the mobile computer down till you hear a 'click' to make sure it is secured in the charging station.
If the Hardshell is installed on the mobile computer, remove the cap on the Cradle's charging station, and insert the mobile computer.
- 2) Connect the adapter to the Cradle, and plug the other end into an electrical outlet.

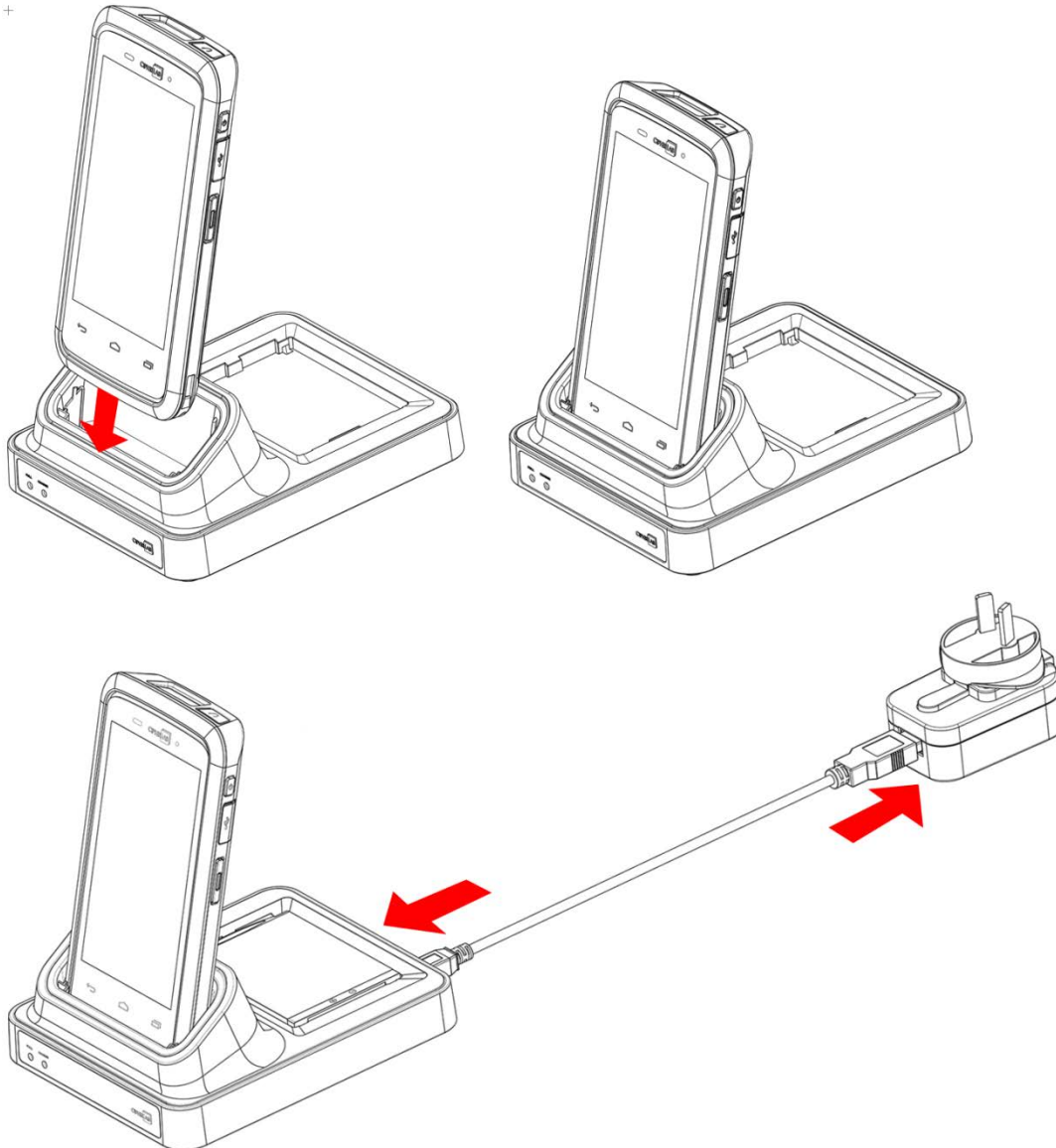

RS30 Cradle LED Indicator	Status	Description
Charging	Red, solid	Charging the mobile computer
	Red, blink	Charging error
	Green, solid	Charging complete
	No light	Charging error (charging will stop)

1.2.2. WIRED DATA TRANSMISSION

Use the micro USB cable to connect the mobile computer to your PC for data transmission.

1.2.3. USING WIRELESS NETWORKS

The mobile computer supports widely applied wireless technologies including Bluetooth v4.0 & v2.1+EDR, 802.11b/g/n and NFC, and is able to send/receive data in real time in an efficient way. Select GSM/GPRS/EDGE/WCDMA/UMTS/HSDPA/HSUPA/HSPA+ modules embedded for a total wireless solution for data and voice communication.

USING THE RS30 MOBILE COMPUTER

This chapter explains the features and usage of the mobile computer.

IN THIS CHAPTER

2.1 Battery	18
2.2 Memory	24
2.3 Touch Screen	26
2.4 Notifications	29
2.5 Date and Time	31
2.6 Language & Keyboard Input	32
2.7 Sound and Volume	33
2.8 Data Capture.....	38
2.9 Snap-on USB Charging Cable	39
2.10 Charging Cradle	40

2.1. BATTERY

▶ Main Battery

The mobile computer is powered by a rechargeable 3.7V / 2500mAh Li-ion battery pack, and it takes approximately 4 hours to charge it to full from the power adaptor. However, the charging time may vary by your working condition.

▶ Spare Battery

A spare battery pack is provided as an accessory. We recommend keeping a fully charged spare battery at hand in order to replace the main battery when it is nearly drained out.

▶ Backup Battery

Settled on the main board is a backup battery that keeps the mobile computer in suspension when the main battery is depleted. The backup battery is a 60 mAh rechargeable Li-ion battery, and can retain data in the DRAM for 30 minutes when it is fully charged (as long as wireless modules on the mobile computer are inactive). The backup battery can be charged by the main battery or the power adaptor, and takes approximately 3.5 hours to charge to full.





Warning:



- (1) The battery cover must be secured in position. If not, the mobile computer cannot turn on by pressing the power key.
 - (2) For a new battery, make sure it is fully charged before using.
 - (3) To avoid data loss, when replacing the main battery, make sure you replace it with a well-charged spare battery pack. Always prepare a spare battery at hand, especially when you are on the road.
 - (4) When the mobile computer has been on backup battery for 30 minutes, the system will shut down. Be sure to replace the main battery as soon as possible in order to avoid data loss.
-

2.1.1. BATTERY STATUS INDICATORS

The main battery pack is the only power source for the mobile computer to work. Therefore, when the main battery level goes low, you need to replace the battery pack with a charged one or charge it as soon as possible. Most of all, you should backup important data on a regular basis.

By checking the battery status icon, you can tell the battery level remaining in the main battery.

Battery Icon	Description
	External power source is connected and main battery is being charged.
	Main battery is fully charged.
	Main battery level is partially drained.
	Main battery level is low.
	Main battery level is very low and needs charging immediately.

Note: When the mobile computer is fully charged and battery level reaches 100%, the battery icon will change from  to  to indicate charging is completed.

Warning:

- (1) Once the battery level drops below 15%, the low battery notification will be displayed on the screen.
- (2) Data loss with RAM may occur when battery level is low. Always save data before the battery runs out of power or keep a fresh battery for replacement.
- (3) Constant usage of the mobile computer at low battery level can affect battery life. For maximum performance, recharge the battery periodically to avoid battery drain out and maintain good battery health.

2.1.2. MONITOR BATTERY LEVEL

MAIN BATTERY LEVEL

The main battery is the only source that feeds the mobile computer to work. It also supplies the backup battery on the main board in order to retain the data stored in DRAM. When main battery level gets low, recharge it or replace it as soon as possible. Most critically, back up the important data from time to time to protect your work.

To check main battery level:

Tap **Home**  | **Settings**  | **Battery** .

Battery level percentage is also shown to provide a clear grasp of the remaining battery power. The screen also shows the rate of battery discharge since the last battery charging session, how long the device has been running on battery power, and which applications are consuming the most battery power.

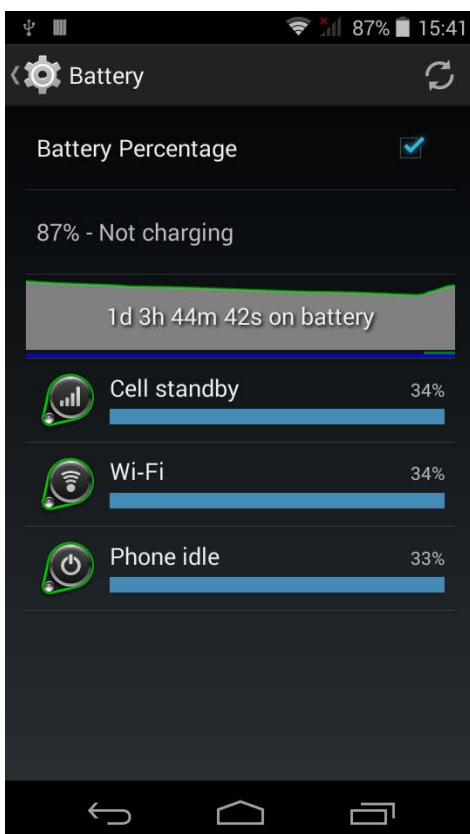

LOW BATTERY ALERT

When the main battery level drops to 15%, the mobile computer prompts a warning reminding you to charge the main battery. Connect the mobile computer to an external power source, or replace the main battery pack as soon as possible.

To replace the main battery pack, see [Replace Main Battery](#).

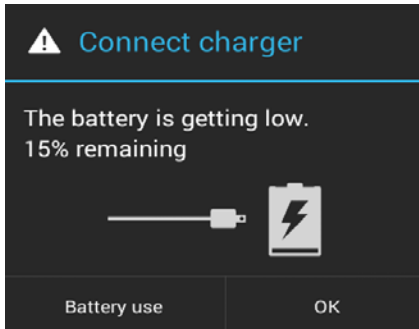

2.1.3. REPLACE MAIN BATTERY

When main battery level is low, follow the steps below to replace the main battery.

- 1) Press and hold the power button on the side of the mobile computer.
- 2) Tap power off in the pop-up menu. The mobile computer will power off.

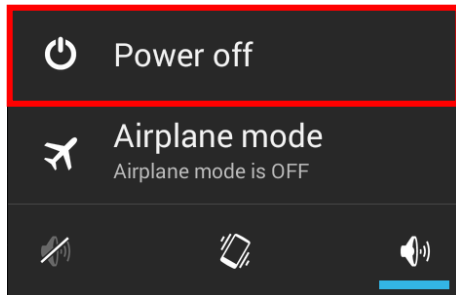

- 3) Open the battery cover and insert a charged main battery as in [Installing Battery](#).
- 4) Press the power button to power on the mobile computer.

Note:

- (1) Before replacing the main battery, make sure the backup battery is well-charged in order to avoid unnecessary data loss.
- (2) After removing the main battery, insert a well-charged battery as soon as possible.

2.1.4. POWER MANAGEMENT

For any portable device, power management is a critical issue especially when you are on the road. Below are some tips to help you save battery power.

Warning: Using backlight, wireless connectivity, and peripheral devices while on battery power will substantially reduce battery power.

- ▶ Bring an additional main battery pack with you on the road.
- ▶ End wireless connections (such as Bluetooth v4.0 & v2.1+EDR, 802.11b/g/n, GSM/GPRS/EDGE/WCDMA/UMTS/HSDPA/HSUPA/HSPA+, NFC and GPS) which are not in use.
- ▶ Shorten the screen turn off time. See [Screen Timeout Settings](#).
- ▶ Reduce the screen brightness level. See [Screen Brightness](#).
- ▶ Shut down automatic data syncing of applications (such as Email, Calendar, Contacts).

2.2. MEMORY

- ▶ Flash Memory (ROM)

8GB flash memory for storing the OS (Android 4.4.2) and custom application programs.

- ▶ Random-access Memory (RAM)

1GB RAM for storing and running programs, as well as storing program data.

- ▶ Expansion Slot

The mobile computer is equipped with one microSDHC card slot which accommodates an SD card up to 32 GB (microSDXC is supported as well).

CAUTION OF DATA LOSS

When the main battery is removed or drained, the backup battery on the main board takes over to supply the mobile computer and keep it in suspension. A fully charged backup battery will retain the data in the RAM for 30 minutes. When the backup battery is drained out as well, the mobile computer will shut down, and only the contents of RTC will be retained. All other unsaved data will be lost.

If you want to put away the mobile computer for a couple of days, you should be aware that data loss occurs when the main battery and backup battery discharges completely. Therefore, it is necessary to backup data and files before putting away the mobile computer.

2.2.1. CHECK STORAGE SPACE

Tap **Home**  | **Settings**  | **Storage**  to check usage of the internal and external storage spaces.



2.3. TOUCH SCREEN

The mobile computer comes with a 4.7" transmissive LCD with 960 by 540 pixels resolution (qHD). The LED backlight of the screen, which helps ease reading under dim environments, can be controlled manually and automatically.

Warning: DO NOT use any pointed or sharp objects to move against the surface of the screen.

2.3.1. SCREEN BRIGHTNESS

Tap **Home**  | **Settings**  | **Display**  | **Brightness**.

Adjust screen brightness by dragging the slider to the right (to increase brightness) or left (to reduce brightness). Select the **Economical backlight** checkbox to enable automatic backlight adjustment with the mobile computer's built in sensor.

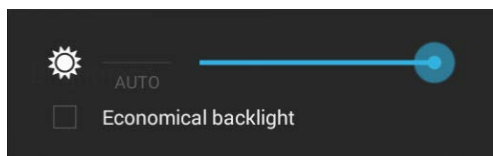

Note: To save battery power, dim the screen brightness while working in a well-lit area, or set a shorter sleeping plan for the screen backlight to go off.

2.3.2. SCREEN ROTATION

For the mobile computer to automatically adjust screen orientation:

Select **Home**  | **Settings**  | **Display**  | **Auto-rotate screen**.

Note: The Home Screen does not rotate.

2.3.3. SCREEN TIMEOUT SETTINGS

Tap **Home**  | **Settings**  | **Display**  | **Sleep**.

Select the time for screen timeout.

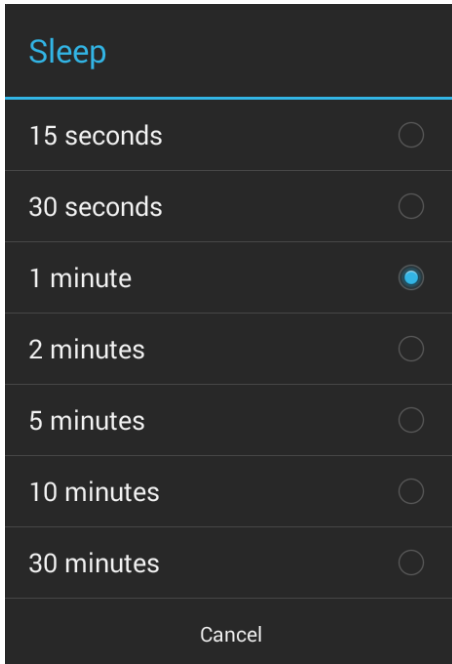

2.3.4. TEXT SIZE

Tap **Home**  | **Settings**  | **Display**  | **Font Size**. Select the font size between Small, Normal, Large and Extra Large.

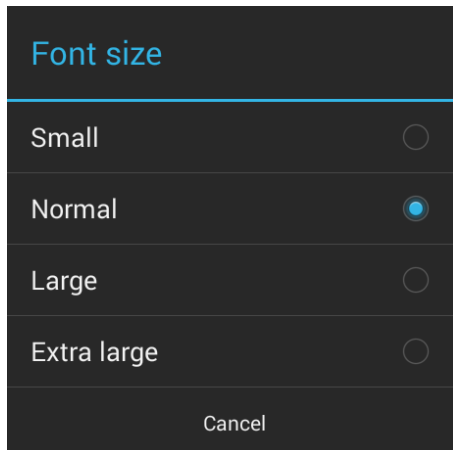

2.4. NOTIFICATIONS

2.4.1. STATUS LED

An LED indicators located above the touch screen provide information about charging status, scanner light beam, and scanner "Good Read" during data collection.

Indicator	Status	Description
Charging	Green, solid	Charging complete
	Red, solid	Charging the mobile computer
	Red, blinking	Charging error (for instance, battery not in place)
Barcode or wireless tag decode	Green, flash once	Good read
Wireless radio	Blue, blinking	Wi-Fi, Bluetooth, or mobile data is in use

Note: For Scanner decode and Scanner beam LED to function, LED notification must be enabled in Reader Configuration. See [Notification Settings](#).

2.4.2. AUDIO

The speaker is used to play sounds for events in windows and programs, or play audio files. In addition, it can be programmed for status feedback. In noisy environments, you may consider connecting a headset instead. A headset jack is provided on the top of the mobile computer, which is a 3.5 mm DIA stereo earphone jack. The mobile computer also supports using Bluetooth headsets.

Supported audio file formats include: WAV, MP3, AAC, AAC+, Enhanced AAC+, AU (including ADPCM), Midi, XMF, AMR (NB and WB).

Use the volume buttons on the side of the mobile computer to adjust the system volume.

2.4.3. VIBRATOR

The mobile computer is integrated with a vibrator, which is software programmable for tactile feedback. This can be helpful when working in noisy environments.

You may also set the mobile computer to vibrate only, in which all system sounds will be muted and replaced by the vibrator.

Press and hold the power key, and tap the vibrate mode icon  in the menu.

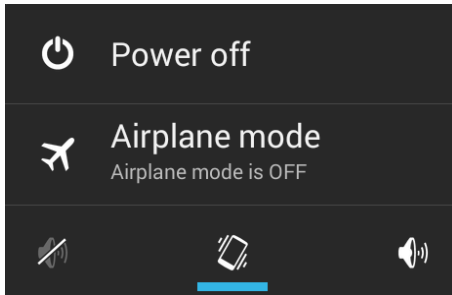



2.5. DATE AND TIME

2.5.1. SET DATE, TIME AND TIME ZONE

By default, the mobile computer automatically synchronizes the date and time to the WWAN network (if connected).

To set the data and time manually:

- 1) Tap **Home**  | **Settings**  | **Date & time** .
- 2) Tap **Automatic data & time** and select **Off** to disable using network-provided time.
- 3) Deselect Automatic time zone.
- 4) Tap **Set date**. Use the sliders to select the correct month, date and year. Tap **Done** to save.
- 5) Tap **Set time**. Use the sliders to select the correct time. Tap **Done** to save.
- 6) Tap **Select time zone**. Select the correct time zone from the list.

2.6. LANGUAGE & KEYBOARD INPUT

Tap **Home**  | **Settings**  | **Language & input** to change the system language, default keyboard type, and configure keyboard input and speech settings.

2.6.1. ON-SCREEN KEYBOARD

Tap a text input field to automatically open an on-screen keyboard.

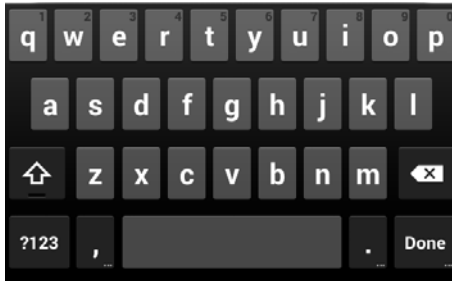

ADJUST KEYBOARD SETTINGS

To configure keyboard settings, tap and hold the comma button  until a settings button



appears. A menu will open allowing you to adjust input language (if you would like to use an input language different from the system language) or keyboard settings.

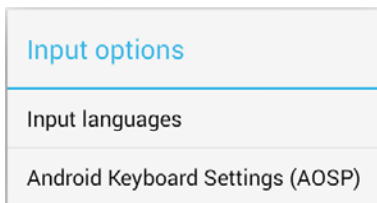

EDIT TEXT

Tap and hold text on the screen to enable a text editing menu for selecting all text, or cutting, copying and pasting text within or across applications. Some applications may use different ways to select or edit text.



ENTER NUMBERS AND SYMBOLS

The top row of keys on the on-screen keyboard have an ellipsis (...) below the character. Tap and hold one of the top row keys until a menu opens, and select a number.

ENTER UPPERCASE LETTERS

Tap and hold the Shift key, and tap a character key to enter an uppercase letter. The letters will return to lower case once an uppercase letter is entered.

ENTER SYMBOLS

Tap  to switch to a keyboard for entering numbers and symbols. On this keyboard,

tap  to open a keyboard for entering special characters. Tap and hold a number or symbol key to open a menu of additional symbols related to that key.



Tap  to switch back to the keyboard for entering lowercase letters.

2.7. SOUND AND VOLUME

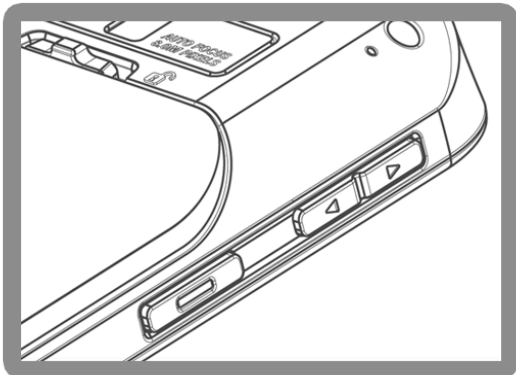
Use the volume buttons on the left side of the mobile computer to adjust system and ringer volume.



2.8. PROGRAMMABLE KEYS

Tap **Home**  | **Settings**  | **Programmable Keys** to assign specific functions to the four programmable keys: volume up, volume down, and the left and right function keys (side keys).

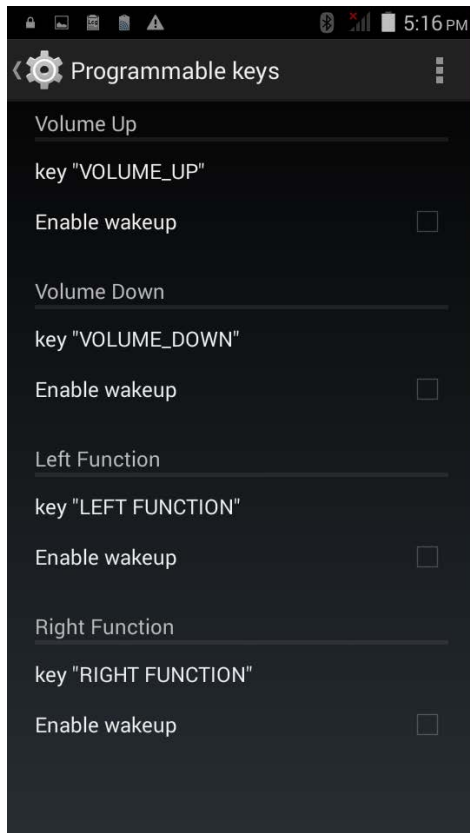

After redefining the programmable keys, tap **Apply** to allow the changes to take effect.

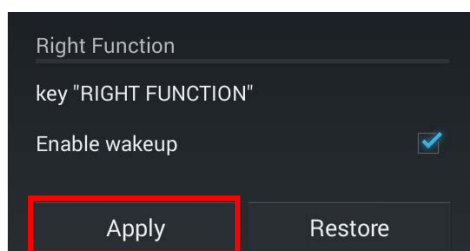

Note: The newly assigned function will not take effect until **Apply** is tapped.

ENABLE WAKEUP

Select the **Enable wakeup** checkbox to enable pressing the key to wake the mobile computer from suspend mode.

Note: This checkbox is automatically disabled if an application is selected for the key on the **Apps** tab page.

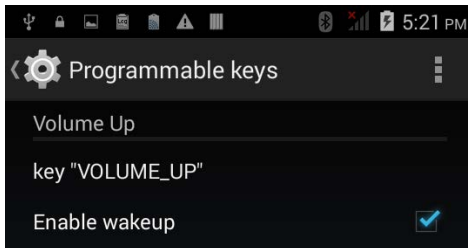

ASSIGN KEYCODE

Tap the key you would like to assign. A screen opens showing a list of available keycodes or applications. On the **Keycodes** tab page, scroll down to view the entire list of keycodes, and tap a keycode to apply.



ASSIGN APPLICATION

Tap the key you would like to assign. Tap the **Apps** tab page to open a list of available applications. Scroll down to view the entire list of applications, and tap an application to apply.

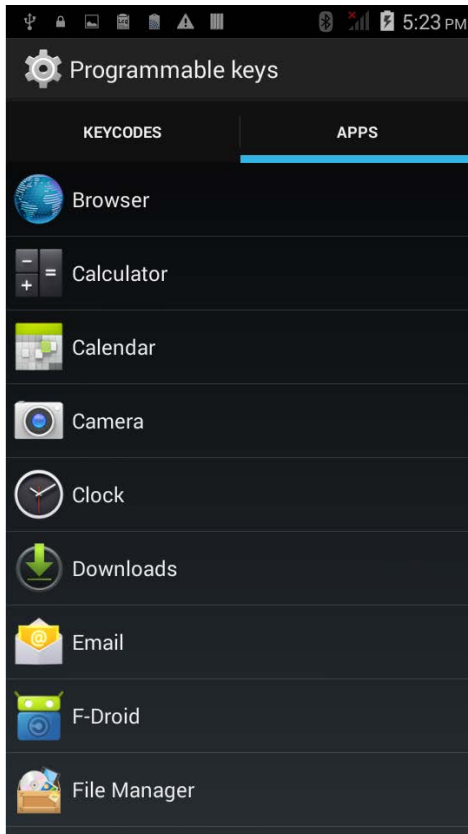

After an application is selected, an icon will appear next to the assigned key. Also, the **Enable wakeup** checkbox will be automatically disabled.

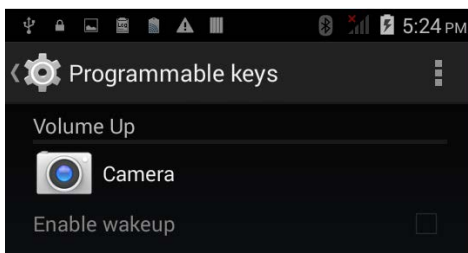

RESTORE FUNCTION

To restore a key to its previously assigned function, tap the **Restore** button in the bottom right corner.

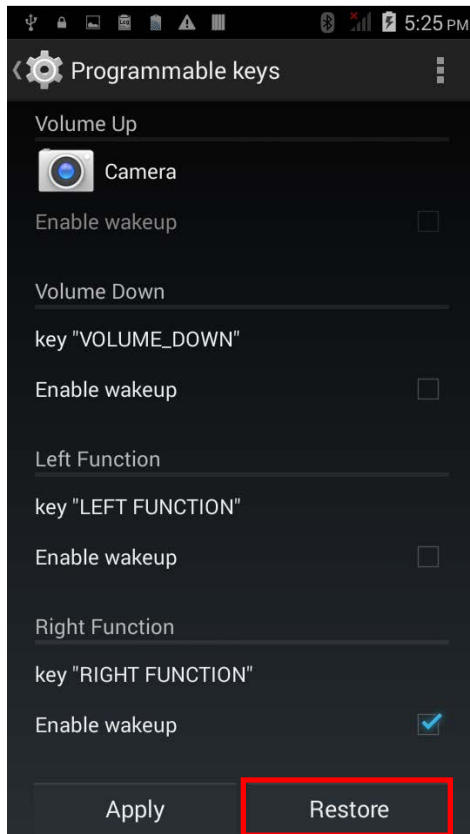

2.9. DATA CAPTURE

2.9.1. BARCODE READER

A selection of scan engines is available for delivering flexibility to meet different requirements. Depending on the scan engine integrated, the mobile computer is capable of scanning barcodes of a number of symbologies that are enabled by default while running the ReaderConfig.exe utility. If you need to scan barcodes that are encoded in a different symbology, enable the symbology first.

2.9.2. DIGITAL CAMERA

An integrated 8 megapixel camera in the mobile computer is specifically designed for collecting image data. You may use the image capture utility to turn on the camera and capture images.

2.10. SNAP-ON USB CHARGING CABLE

The Snap-on USB Charging Cable provides a convenient way to charge your mobile computer.

- ▶ Click the Snap-on USB Charging Cable on to attach; pull either side outwards to detach
- ▶ Connect USB to PC or adapter to charge mobile computer
- ▶ Cable completes charging in approximately 4 hours
- ▶ LED on mobile computer shows charging status
- ▶ Adapter input 100-240VAC, 50/60Hz; output 5VDC/2A

Note: The Snap-on USB Charging Cable is for charging only. For data communication, use the micro USB cable to connect the mobile computer to your PC or laptop.

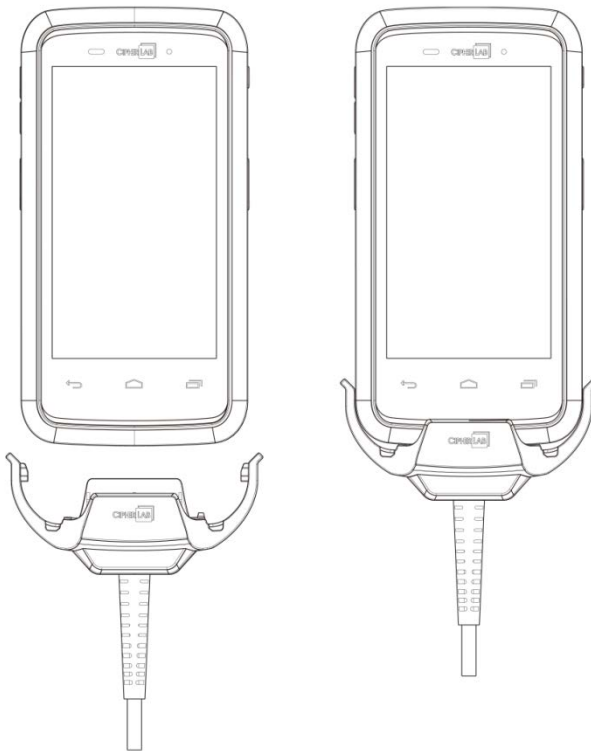

2.11. CHARGING CRADLE

The Charging Cradle charges your mobile computer and a spare battery at the same time.

- ▶ Presents charging compartment for mobile computer and spare battery
- ▶ Provides micro USB socket on the back for charging
- ▶ Supports USB Host Mode via a USB OTG cable
- ▶ Completes charging in approximately 4 hours
- ▶ Two LEDs, one for power connection status and one for battery charging status
- ▶ Adapter input 100-240VAC, 50/60Hz; output 5VDC/2A

Note: The Charging Cradle is for charging only. For data communication, use the micro USB cable to connect the mobile computer to your PC or laptop.

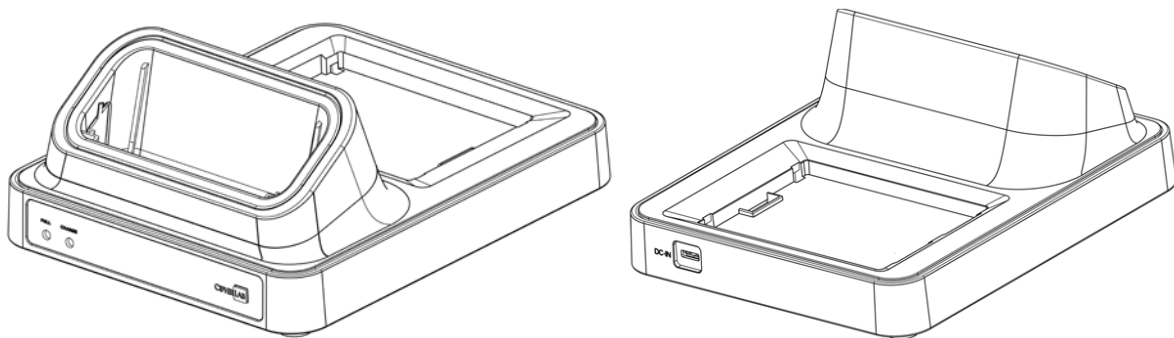

BASIC OPERATION

This chapter describes the basic skills to work with the RS30 Mobile Computer, for instance how to operate the home screen, check system statuses and manage notifications. The add-on utilities for applications regarding data collection, processing, and transmission are introduced in the following chapters.

IN THIS CHAPTER

3.1 Home Screen.....	42
3.2 Widgets	47
3.3 Status Bar.....	50
3.4 Notifications Panel.....	53
3.5 Applications Menu	55
3.6 Manage Applications.....	57
3.7 Suspend & Lock	58
3.8 OS Update	59

3.1. HOME SCREEN

When the mobile computer is fully charged, press the Power key for three seconds to turn on the mobile computer. A locked screen will appear. Slide the lock button  in either direction to unlock the screen.

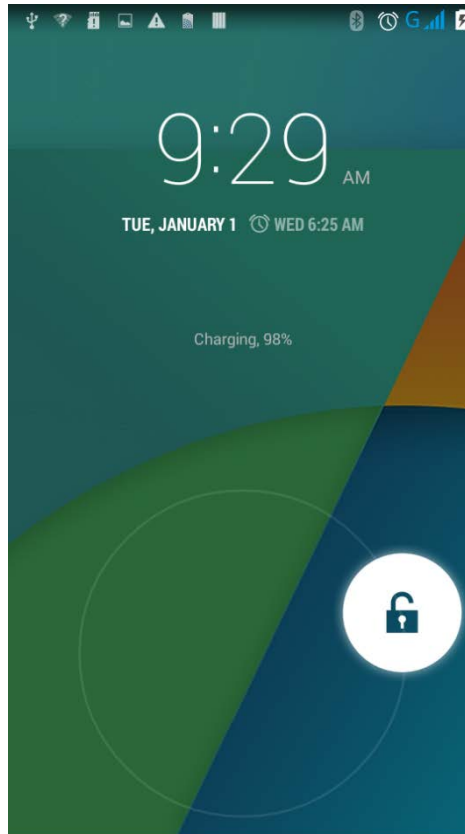
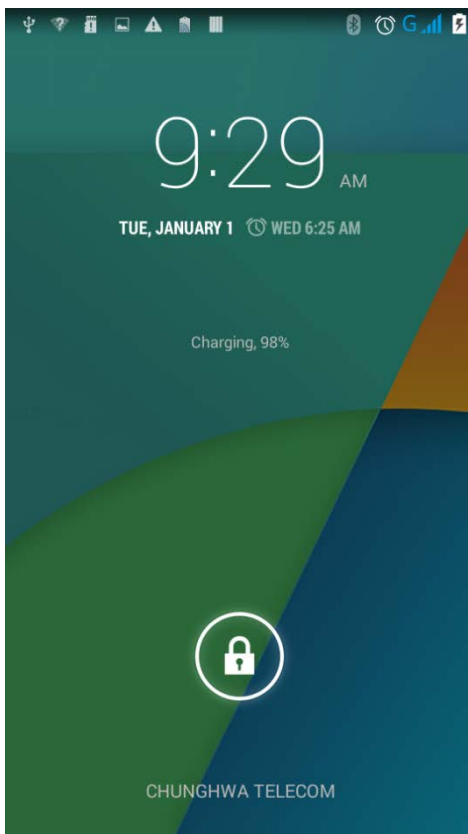

The **Home Screen** appears showing a status bar, shortcut icons, and a dock bar containing an All Apps button. The home screen allows up to four pages for placing shortcut icons and widgets. You may customize the home screen according to your preferences.

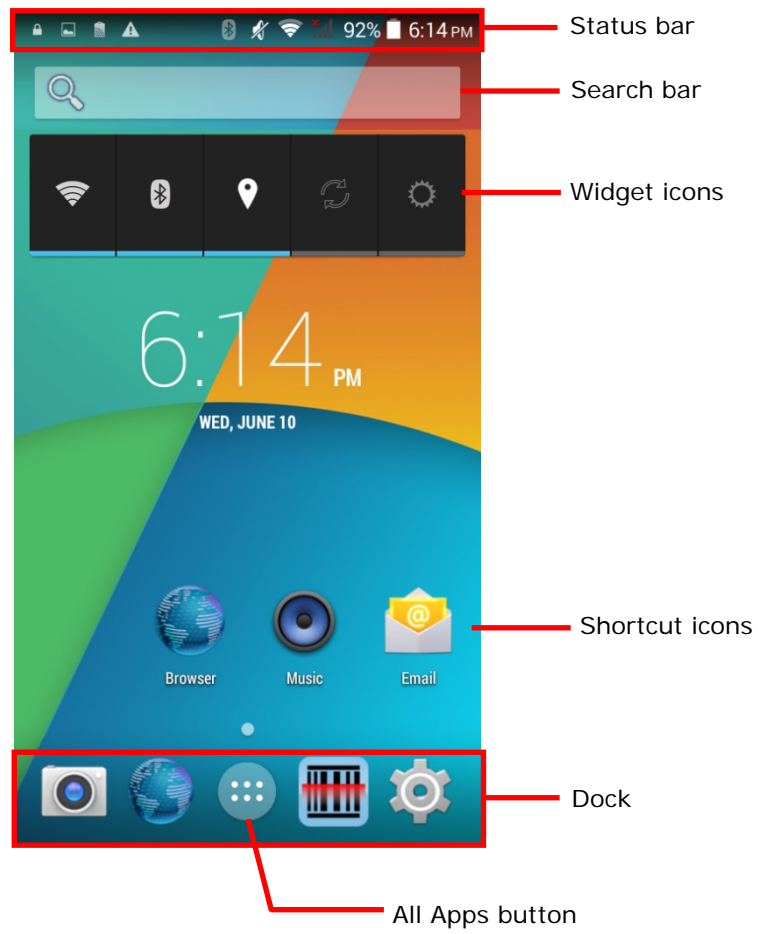

3.1.1. CUSTOMIZE HOME SCREEN

ADD APPLICATION SHORTCUT TO HOME SCREEN

- 1) On the home screen you would like to customize, tap  .
- 2) Locate the application to add.
- 3) Tap and hold the application icon. The home screen will appear.
- 4) Drag the application icon to your preferred position and release to have it placed.

ADD WIDGET TO HOME SCREEN

- 1) Tap and hold any empty spot on the home screen.
- 2) Tap **Widgets** in the menu that appears.
- 3) Tap and hold the widget to add. The home screen will appear.
- 4) Drag the widget to your preferred position and release to have it placed.

MOVE APPLICATION SHORTCUTS ON HOME SCREEN

- 1) On the home screen you would like to customize, tap and hold the application shortcut you would like to move.
- 2) Drag the icon to the preferred position and release it to have it placed.

REMOVE APPLICATION SHORTCUT OR WIDGET FROM HOME SCREEN

- 1) On the home screen you would like to customize, tap and hold the application shortcut or widget you would like to move.
- 2) Drag the icon to the top of the screen where the remove icon  is located.

CREATE FOLDER

- 1) On the home screen you would like to customize, tap and hold the application shortcut you would like to move.
- 2) Drag the icon on the top of another icon to create a folder.

NAME FOLDER

- 1) Tap the folder you would like to name.
- 2) Tap **Unnamed Folder** and edit the folder name.
- 3) Tap **Done** on the on-screen keyboard.

REMOVE FOLDER

- 1) Tap and hold the folder you would like to remove.
- 2) Drag the folder to the top of the screen where the remove icon  is located.

CHANGE HOME SCREEN WALLPAPER

- 1) Tap and hold any empty spot on the home screen.

- 2) Tap **Wallpapers** in the menu that appears.
- 3) Select an image to apply as the wallpaper.
- 4) Tap **Set wallpaper** at the bottom of the wallpaper preview screen to apply it.

3.1.2. CUSTOMIZE WALLPAPER

- 1) Tap and hold any empty area on the Home Screen. A settings menu for the Home Screen will open at the bottom.



- 2) Tap **WALLPAPER** in the settings menu.

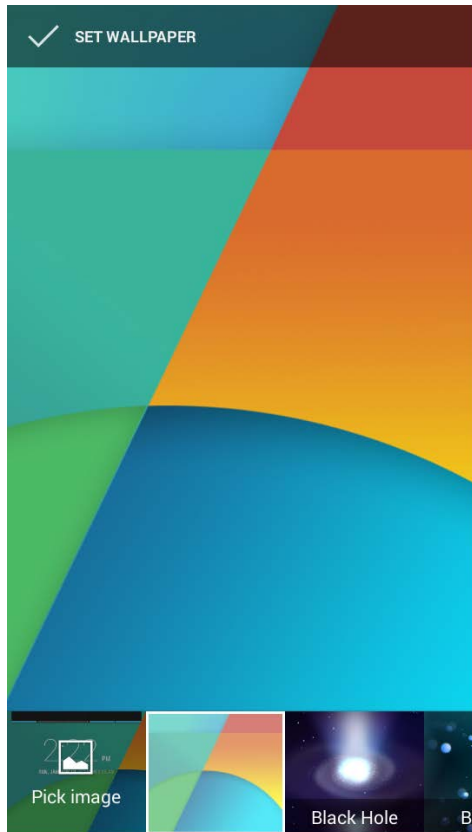



- 3) A wallpaper selection screen opens. Scroll through the wallpapers to select a wallpaper to apply.

3.2. WIDGETS

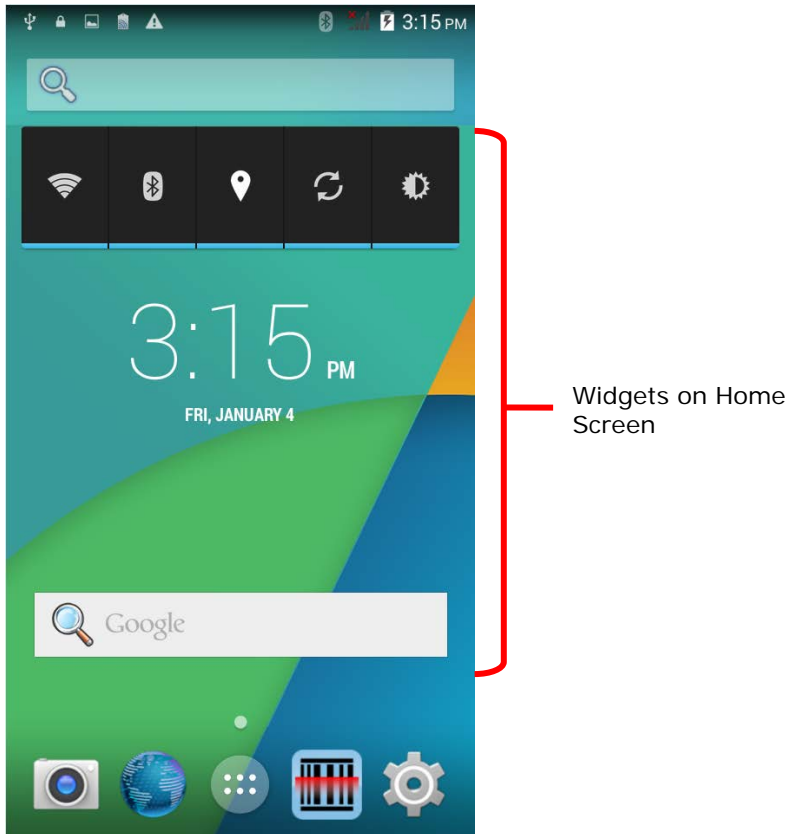
Widgets are designed for easy control of settings and viewing of status. Enabled widgets will be displayed on the Home Screen.

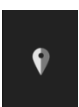
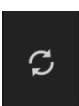

By default, two widgets are enabled, the power control widget and digital clock widget.

Default Widget	Icon	Description
Power control		Wi-Fi control. Tap to Power On/Off Wi-Fi .
		Bluetooth control. Tap to Power On/Off Bluetooth .
		GPS control. Tap to set GPS mode between high accuracy and battery saving.
		Data syncing control. Tap to sync data of your Google account.

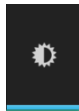

Screen brightness control. Tap to set the screen brightness profile between full, half, dim or auto.

Digital clock

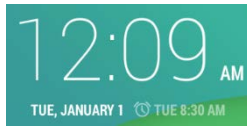

Shows the current time, date and the set alarm.

3.2.1. ADD WIDGETS

To add a widget:

- 1) Tap and hold any empty area on the Home Screen. A settings menu for the Home Screen will open at the bottom.



- 2) Tap **WIDGETS** in the settings menu.
- 3) A widget menu opens. Tap and hold a widget and drag it to the Home Screen you would like to place it on.



3.2.2. REMOVE WIDGETS

To remove a widget:

- 1) Tap and hold a widget so it becomes highlighted. The widget is available for relocation.
- 2) Drag the widget to the top of the screen where a remove icon is located. The remove icon will change to red to indicate the widget is about to be removed.

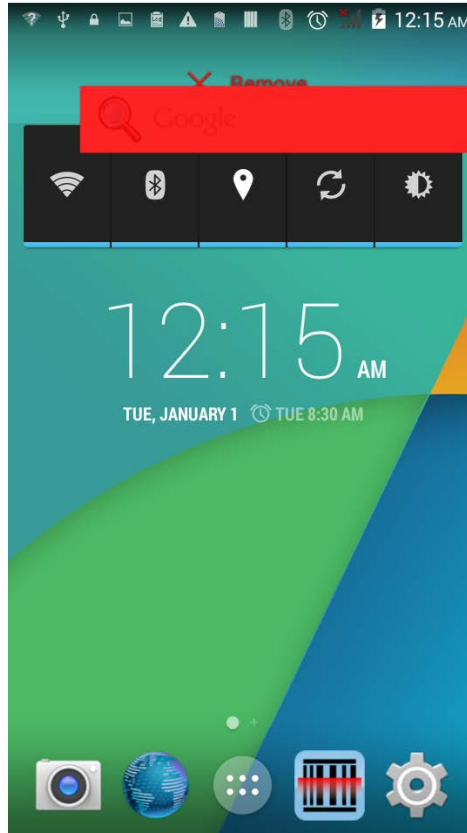





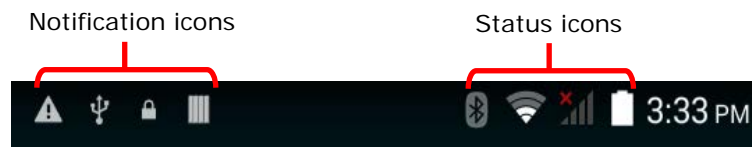



3.3. STATUS BAR

The left side of the status bar shows notification icons, and the right side of the status bar shows status icons.















NOTIFICATION ICONS











Icon	Description
	More notifications are available, tap to show the Notifications Panel
	Upcoming event
	Data is syncing
	A problem has occurred with sign-in or data sync
	A new system update file is available on the server
	A song is currently playing
	Preparing storage card
	Storage card is almost full
	Uploading data
	Downloading data; when download is finished, icon stops flashing
	Connected to PC via USB cable. Change the type of USB connection by viewing the notification in the Notifications Panel
	No SIM card detected in either of the two SIM card slots
	NFC is enabled
	Multiuser feature is enabled
	New user is logged in

	Text message is received
	Missed call
	Car mode is active
	Connected to/disconnected from VPN network
	Bluetooth tethering is active
	USB tethering is active
	Wi-Fi network is available
	Wi-Fi hotspot is active

STATUS ICONS

The icons at the top of the screen are explained below.

Icon	Description
	GPS is active
	Currently searching for location data
	Alarm is active
	Vibrate mode is active; all system sounds (except media and alarms) are muted
	Phone ringer is muted
	Microphone is muted during a call
	Battery is fully charged
	Battery is partially drained
	Battery level is very low
	Battery is almost completely drained and needs charging immediately
	Battery is charging
	Airplane mode is active

	Bluetooth is active
	Connected to a Bluetooth device
	Connected to a Wi-Fi network
	No Wi-Fi signal detected
	Signal strength of mobile network
	No mobile network signal
	Connected to 3G network
	Connected to HSPA network
	Connected to EDGE network
	Connected to GPRS network
	No SIM card installed

3.4. NOTIFICATIONS PANEL

Use a downwards sliding motion from the top of the screen to open the notifications panel. To close the panel, slide the screen back upwards.

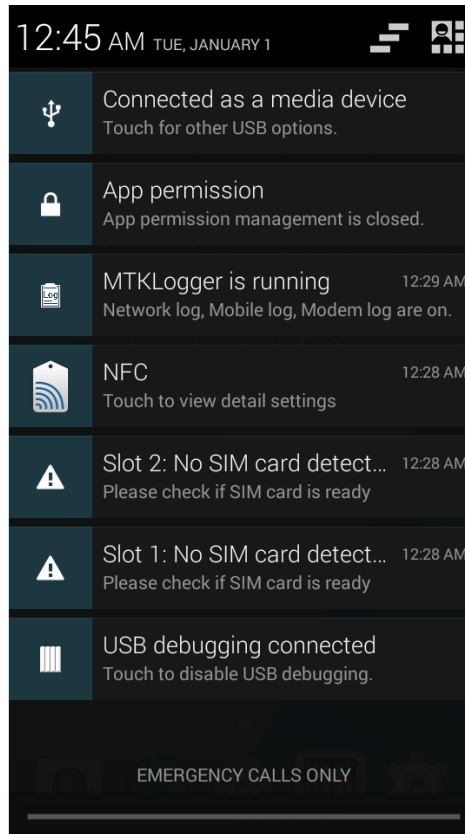
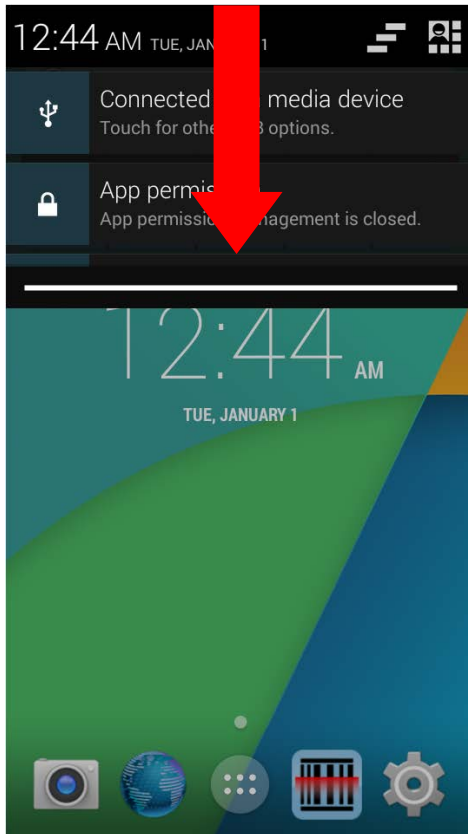

VIEW NOTIFICATIONS

Tap a notification message to enter a page for subsequent activity. The activity required for each notification will differ.

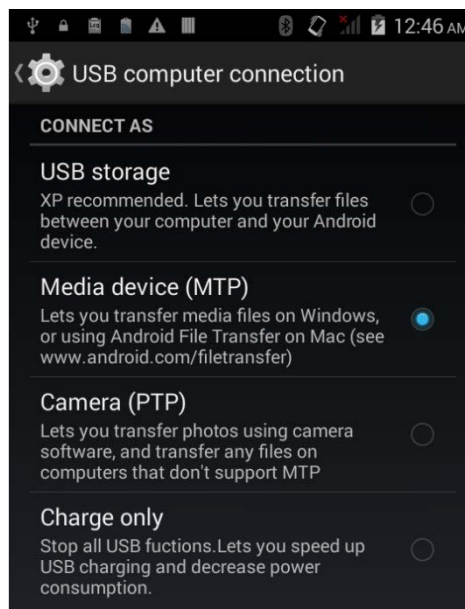
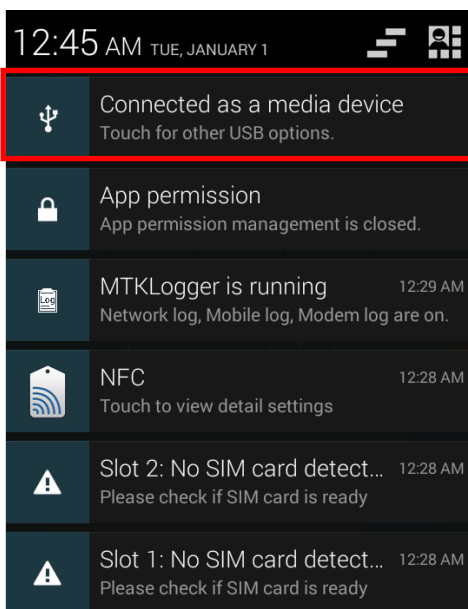

CLEAR NOTIFICATION















Slide each notification sideways to have it cleared. Some notifications will require subsequent activity to be cleared; tap the notification to enter a corresponding settings page for taking further steps.













CLEAR ALL NOTIFICATIONS

Tap  on the status bar to clear all notifications. Ongoing notifications and notifications that require subsequent activity to be cleared will remain in the list.

3.5. APPLICATIONS MENU

Tap  on the Home screen to open the applications menu.

Icon	Name	Description
	Browser	Accesses the internet or intranet.
	Calculator	Performs mathematical calculations.
	Calendar	Creates and manages events, meetings and appointments.
	Camera	Takes pictures and shoots videos.
	Clock	Sets date, time, time zone according to your locale, and sets and manages alarms.
	Downloads	List all files downloaded on the mobile computer.
	Email	Sends and receives emails.
	F-Droid	Free market service for browsing, installing and keeping track of applications for Android platform.
	File Manager	Browses and manages files on the local storage and storage card.
	Gallery	Views photos and videos stored on the mobile computer.
	MAPS.ME	Tracks your current location, searches for specific locations, plans routes to target destinations, and offers downloadable map data.
	Messaging	Sends SMS and MMS messages.
	Movie Studio	Creates movies with the video files stored on the mobile computer.
	Music	Plays music and audio files stored on the mobile computer and storage card.
	People	Manages contact information, and shares or exports/imports the information to other devices or SD card.

	Phone	Places and receives calls, accesses voicemail, views call history, manages phone contacts and adjusts phone settings.
	Reader Config	Sets scanner preferences, data output format and destination, symbology settings, and reads barcodes.
	Search	Searches the internet and mobile computer with the Google search engine.
	Settings	Opens settings to configure the mobile computer.
	SIM Toolkit	Additional services provided by your mobile carrier.
	Sound Recorder	Records and plays audio information.
	ToDo	Manages tasks to do.
	Videos	Plays video files taken or stored on the mobile computer.
	Zello	Allows the mobile computer to be used as a walkie talkie by connecting to either a Wi-Fi network or cellular network. Set up channels to create groups talks, and enable encryption to provide secure communication.
	UnifiedNlp	<p>Location provider middleware which can be used along with a backend service to provide geolocation service through Wi-Fi network or cellular network. Configure a backend to use for geolocation or address lookup,</p> <p>then activate UnifiedNlp in Home  Settings  Location . Launch a front-end location discovery application for location tracking.</p>

3.6. MANAGE APPLICATIONS

3.6.1. CURRENT APPLICATIONS

Tap and hold the Home button . The screen will show a list of recently used applications.

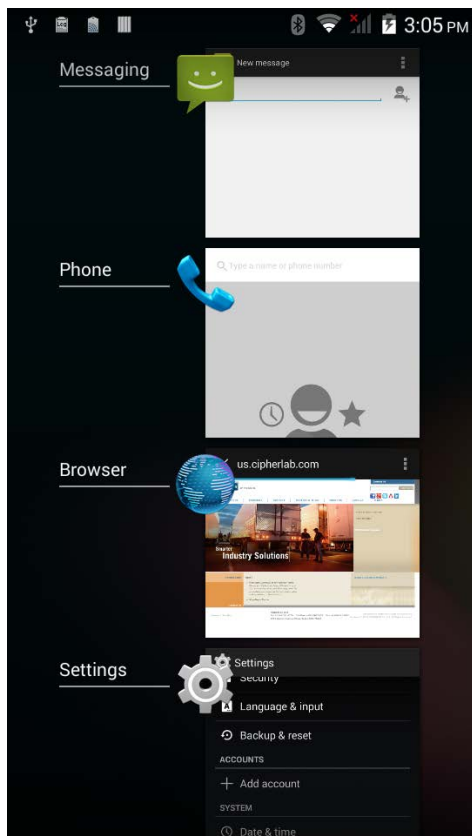

Actions to take on this screen include the following:

SWITCH BETWEEN APPLICATIONS

Tap one of the listed applications to open it on the screen.

END APPLICATION

Slide an application to the left or right to close it.

Note: Close unused applications in order to release RAM. Remember to save your data or settings before closing any application.

3.7. SUSPEND & LOCK

3.7.1. SUSPEND DEVICE

The mobile computer operates continuously once it is powered on. To minimize power consumption and prevent unintended operation, suspend the mobile computer if you are not actively using it. The mobile computer can be quickly awoken from suspend mode to operate as needed. When the mobile computer enters suspend mode, the system is in a power-saving status, meaning the device will not respond to screen touch, and volume keys and side buttons will also be unavailable until the device is unlocked.

SUSPEND RS30

Press the power button to suspend the mobile computer. The mobile computer will automatically suspend when the time period set in [Screen Timeout Settings](#) has passed without any activity.

3.7.2. LOCK DEVICE

LOCK RS30

Tap **Home**  | **Settings**  | **Security**  | **Screen lock** to change the lock method.

- ▶ None
- ▶ Slide: Uses the default slide gesture to unlock a locked screen.
- ▶ Voice Unlock: Select a voice command to use for unlocking the screen.
- ▶ Pattern: Enter a pattern to use for unlocking the screen.
- ▶ PIN: Uses the PIN code to unlock a locked screen.
- ▶ Password: Enter a password of at least 4 characters for unlocking the screen.

UNLOCK RS30

When the mobile computer is in suspend mode, pressing the power button will wake it up. If a lock method is set, follow the gestures below to unlock the screen:

- ▶ None
- ▶ Slide: Slide the lock icon in either direction so it relocates outside of the white circle.
- ▶ Voice Unlock: Say the voice command to unlock.
- ▶ Pattern: Swipe the set pattern to unlock.
- ▶ PIN: Enter the PIN code to unlock.
- ▶ Password: Enter the password unlock.

Warning: To save battery power, suspend the mobile computer when not in use.

3.8. OS UPDATE

Updating the operating system on the mobile computer helps maintain it at an optimized state. You may choose to update the system by establishing a wireless network and downloading the update file from the server, or by using an SD card.

Note: The mobile computer will shut down during system update. Save any unfinished tasks and data before updating the system in order to avoid data loss.

NETWORK UPDATE

1) In order to check for and download the latest system update file on the server, make sure a wireless network connection is established on the mobile computer.

Note: To avoid any additional charges to your wireless data plan, Wi-Fi connection is recommended for downloading the file.

2) Tap **Home**  | **Settings**  | **About phone**  | **System updates**.

A window pops up asking you to input the password for system update. Enter the password and tap **OK**.

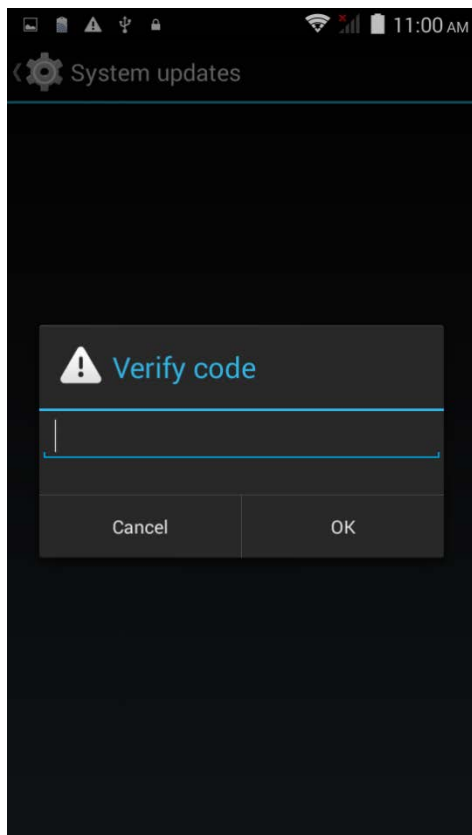

- 3) The mobile computer searches for the latest system update file on the server. Tap **DOWNLOAD AND INSTALL** to download the update file. Tap  to refresh.

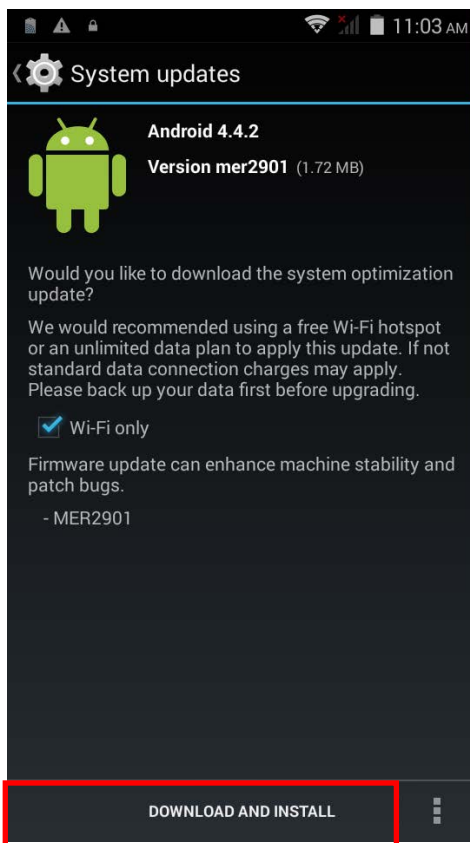

When a new system update file is detected on the server, a notification icon will appear on the status bar, and a text notification will pop up in the notifications panel.

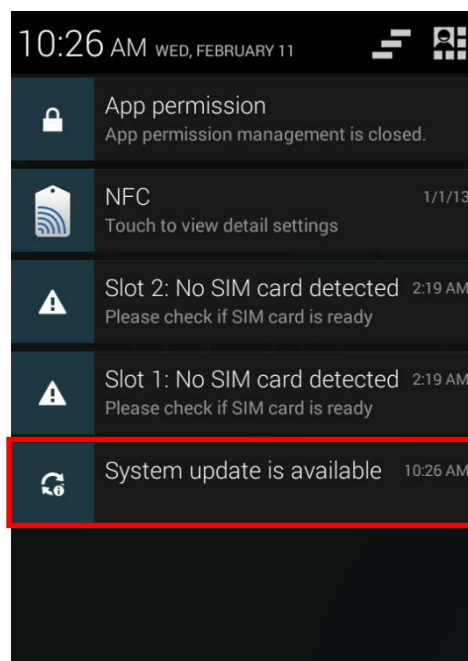
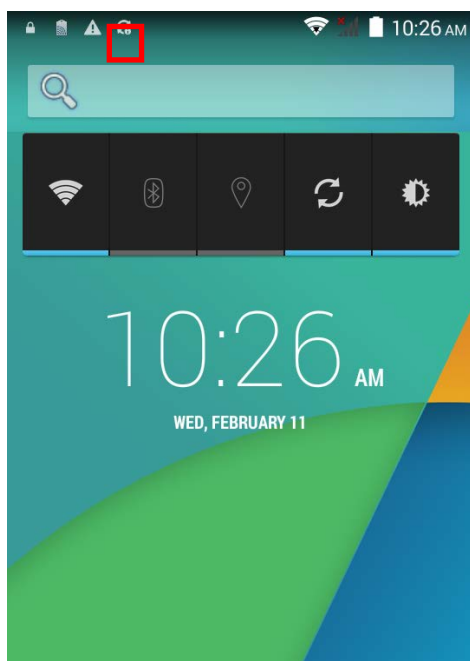

If your mobile computer has the latest version installed already and there is currently no later version available, or if no wireless connection is established, the System updates screen will show the following message:

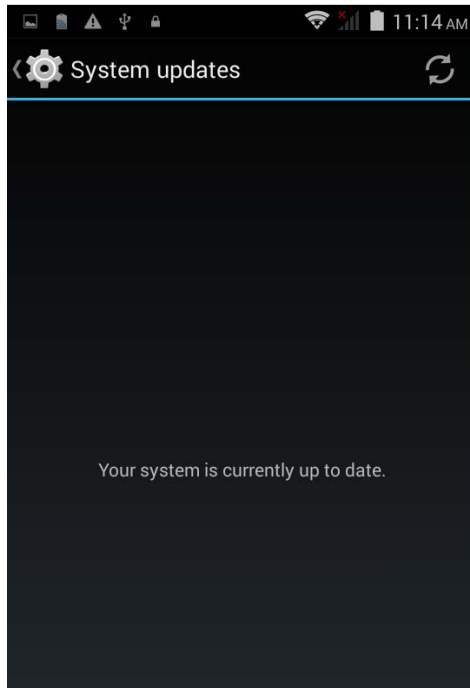

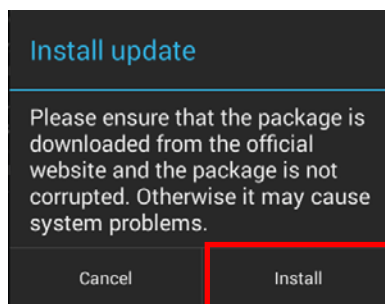
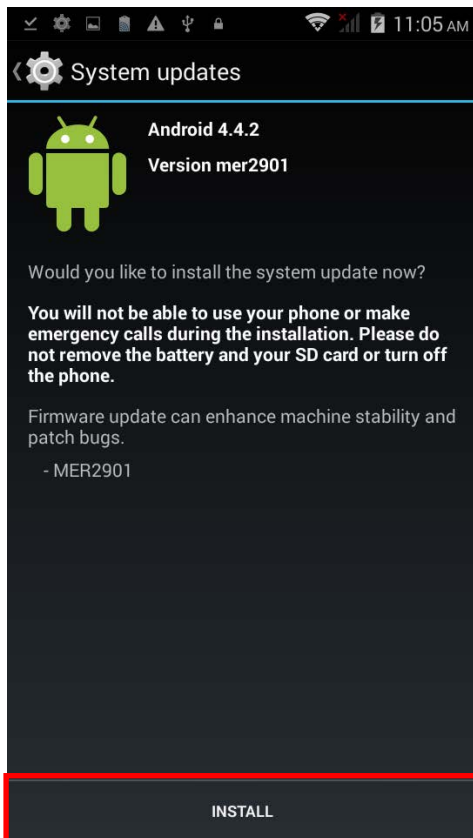

- 4) When the system update file has been downloaded, tap **INSTALL** to open an “Install update” confirmation window. Tap **Install** in the confirmation window to begin the installation.

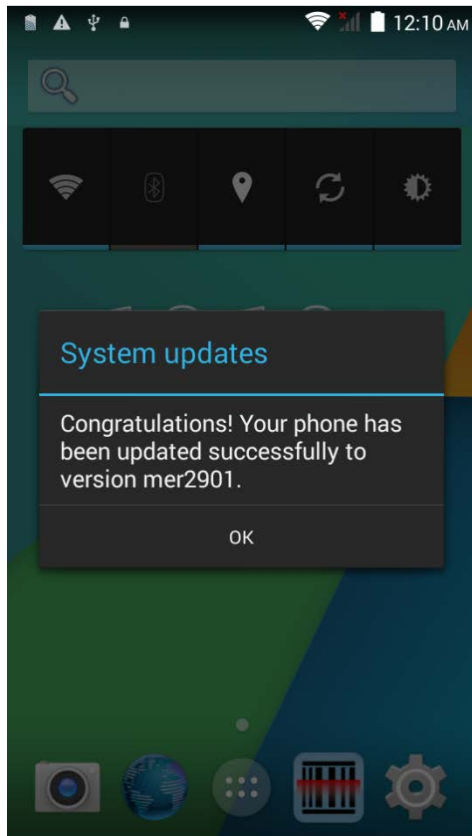

- 5) Once complete, a notification will appear showing that the system has been updated successfully. Tap **OK** to show the Home screen.



SD CARD UPDATE

- 1) Obtain the latest system update file, and copy the file onto the root storage of your SD card.
- 2) Insert the SD card into the memory card slot on the mobile computer. Press the power button to power it on.
- 3) Tap **Home**  | **Settings**  | **About phone**  | **System updates**.

A window pops up asking you to input the password for system update. Enter the password and tap **OK**.

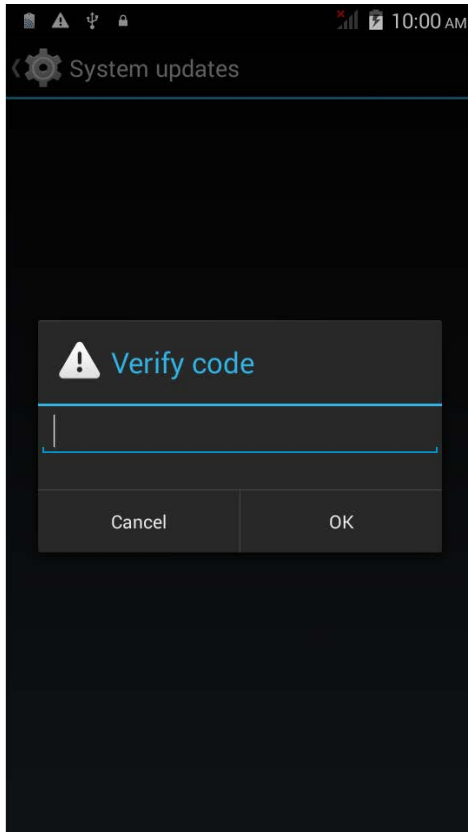

- 4) The mobile computer searches for an available system update file on the SD card.

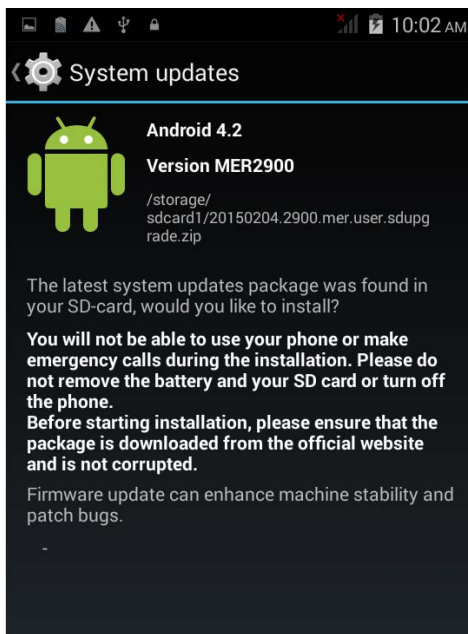

Note: Make sure the SD card is inserted in the mobile computer. If not, the screen will show that your system is currently up to date.

If there is a later version of the system update file available on the server, it will be listed on the screen along with the update file found on the SD card. Tap the update file you would like to use and proceed.

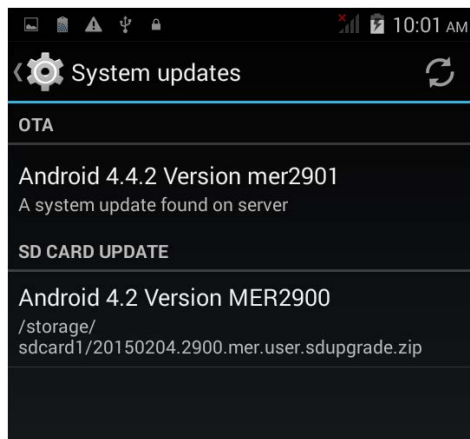

- 5) Tap **INSTALL** to open an "Install update" confirmation window. Tap **Install** in the confirmation window to begin the installation.

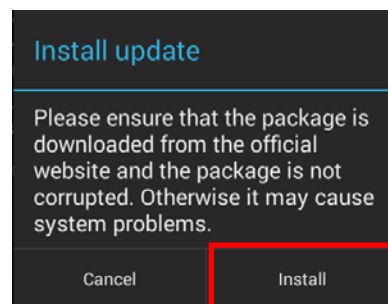
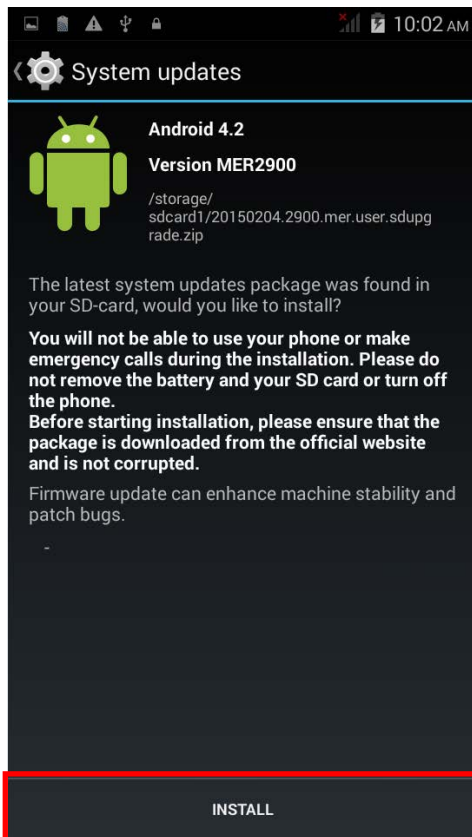

- 6) Once complete, a notification will appear showing that the system has been updated successfully. Tap **OK** to show the Home screen.

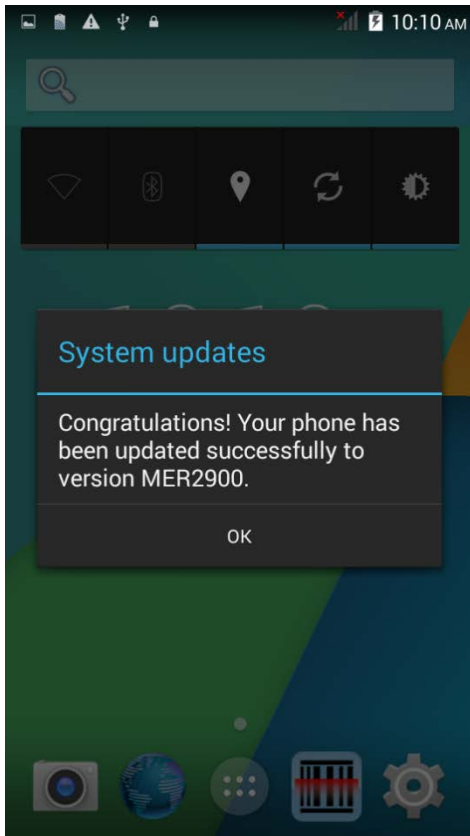

WIRELESS RADIOS

The Wi-Fi module integrated on the mobile computer lets you configure and connect to network wirelessly.

IN THIS CHAPTER

4.1 Use Wireless Wide Area Network.....	68
4.2 Use Wireless Local Area Network (Wi-Fi)	73
4.3 Use Bluetooth.....	80
4.4 Use Near Field Communications	85

4.1. USE WIRELESS WIDE AREA NETWORK

The mobile computer will be automatically configured to connect to your wireless service provider's network when you insert a SIM card and turn on data connection for the first time.

- 1) When a SIM card is inserted, a dialog will appear confirming the mobile carrier detected. By default, data connection is set as "off".

If you would like to change the default settings, tap **Change** to enter the SIM management settings page.

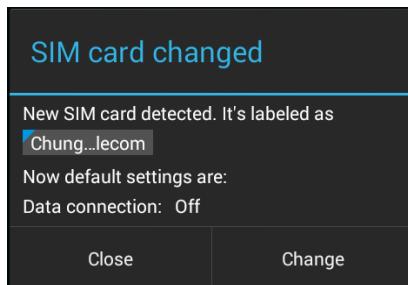



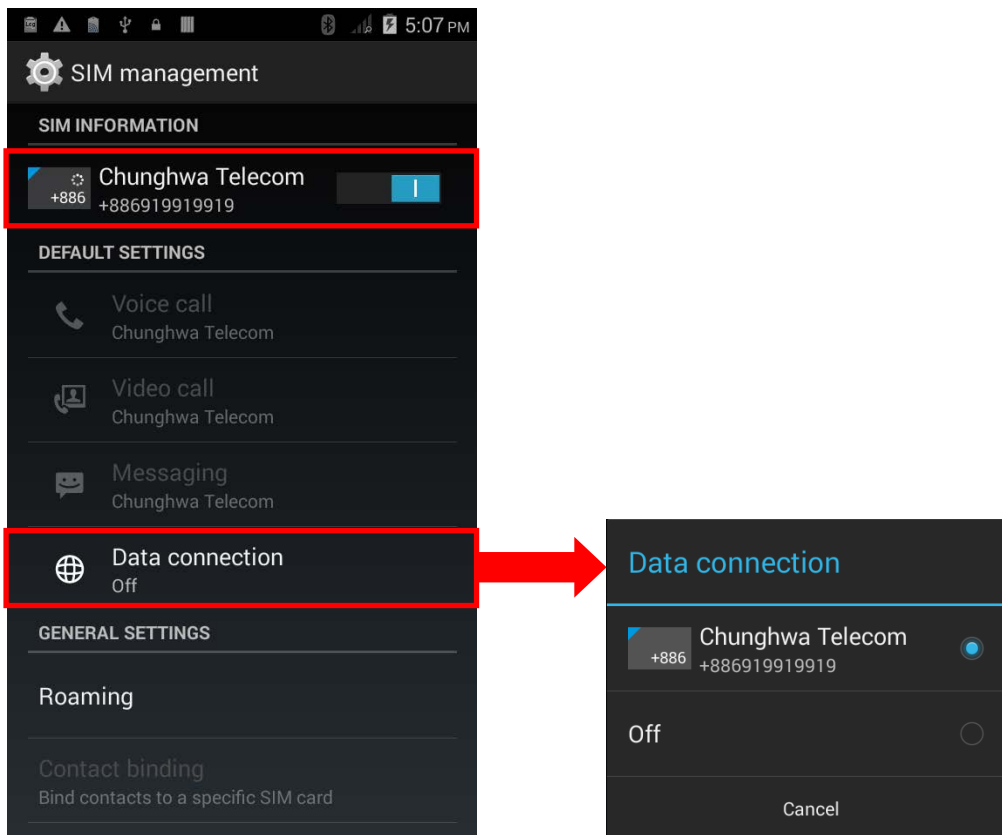

- 2) By default, phone power is turned "on", and data connection is turned "off". To enable mobile data connection, tap **Data connection**, and select the mobile carrier you would like to use.



EDIT ACCESS POINT NAME

You may need to change the access point name according to the information obtained from your mobile carrier.



- 1) Tap **Home**  | **Settings**  | **Mobile networks**.
- 2) On the Network settings page, tap **Access Point Names**.
- 3) Tap the settings button , and tap **New APN** in the pop-up menu.
- 4) Tap each field to input the APN name and settings obtained from your mobile carrier.
- 5) When finished, tap the settings button  and tap **Save**.
- 6) Tap the radio button next to the APN you would like to apply.

4.1.1. SHARE WWAN DATA

The WWAN connection on the mobile computer can be shared to other devices. You may share internet connection with a computer or device through USB or Bluetooth tethering, or share with a maximum of eight devices by turning the mobile computer into a Wi-Fi hotspot.



BLUETOOTH TETHERING

To share data connection through Bluetooth tethering:

- 1) Pair the mobile computer with the device of interest.
- 2) Tap **Home**  | **Settings**  | **More...** | **Tethering & portable hotspot**.
- 3) Tap **Bluetooth tethering**. The mobile computer will share its WWAN network with Bluetooth-connected devices.
- 4) To disable data connection through Bluetooth sharing, uncheck the **Bluetooth tethering** checkbox.



USB TETHERING

To share data connection through USB tethering:

- 1) Connect the mobile computer with a USB cable. A USB icon will appear at the top of the screen, and in the Notifications panel, a description "Connected as USB Storage" will appear.
- 2) Tap **Home**  | **Settings**  | **More...** | **Tethering & portable hotspot**.
- 3) Tap **USB tethering**. The mobile computer will share its WWAN network with the connected host computer.

WI-FI HOTSPOT

To share data connection in the form of a Wi-Fi hotspot:



- 1) Tap **Home**  | **Settings**  | **More...** | **Tethering & portable hotspot**.
- 2) Tap the **Wi-Fi hotspot** switch to enable data sharing through Wi-Fi. The mobile computer will start broadcasting its SSID for other devices to connect.

- 3) Tap the **Wi-Fi hotspot** label to manage Wi-Fi hotspot settings: set when to turn the Wi-Fi hotspot off, change SSID and security settings, select whether to minimize battery usage when Wi-Fi hotspot is enabled, enable WPS mode and adjust bandwidth, and view connected users.

4.1.2. DATA USAGE

Data usage is the amount of data uploaded or downloaded on the mobile computer. Managing the data usage amount within a certain period of time is a recommended task, as an excess amount of data usage might incur additional fees from your service provider.

To check wireless data usage:

- 1) Tap **Home**  | **Settings**  | **Data usage** .
- 2) The **Overview** tab page opens showing a summary of data usage for your mobile network and Wi-Fi connection. Open the tab page of your mobile carrier to view a chart of data usage on a monthly cycle.

SET DATA USAGE LIMIT

- 1) Open the data usage tab page for your mobile carrier.
- 2) Tap the **Mobile data** switch to enable data usage overview.
- 3) Select the **Set mobile data limit** checkbox to enable a limit for mobile data.
- 4) To adjust the limit level, tap the limit value on the chart to open a value selection box. If a limit is set, when the data usage amount reaches the limit, mobile data connection will be automatically disabled.

ENABLE DATA USAGE DURING ROAMING

- 1) On the data usage tab page for your mobile carrier, tap the settings button .
- 2) Select the **Data roaming** checkbox for your mobile carrier.
- 3) A dialog box appears confirming whether you would like to enable data roaming. Tap **OK** to confirm.

RESTRICT BACKGROUND DATA

- 1) On the data usage tab page for your mobile carrier, tap the settings button .
- 2) Select the **Restrict background data** checkbox.
- 3) A dialog box appears confirming whether you would like to enable data restriction. Tap **OK** to confirm.

The mobile computer conserves data usage by restricting background mobile data. Certain applications and services will be disabled unless the mobile computer is connected to a Wi-Fi network.

AUTO SYNC

- 1) On the data usage tab page for your mobile carrier, tap the settings button .
- 2) Select the **Auto-sync data** checkbox.

- 3) A dialog box appears confirming whether you would like to enable data auto-synchronization. Tap **OK** to confirm.

Once auto-sync is enabled, any changes made to your personal account will be automatically reflected on the mobile computer.

4.1.3. DATA CONNECTION SETTINGS



TURN ON/OFF DATA CONNECTION

To manually turn on/off mobile data connection:

- 1) Tap **Home**  | **Settings**  | **More...**  | **Mobile networks**.
- 2) On the **Network settings** page, tap **Data connection** to show a dialog box for selection.
- 3) To turn on data connection, tap the radio button for the mobile carrier of interest. To turn off all data connection, tap **Off**.



3G DATA CONNECTION

To manually turn on/off 3G mobile data connection:

- 1) Tap **Home**  | **Settings**  | **More...**  | **Mobile networks**.
- 2) On the **Network settings** page, tap **3G service**.
- 3) Tap **Enable 3G** to show a dialog box for selection.
- 4) To enable 3G data connection for a specific mobile carrier, tap the radio button for the mobile carrier of interest. To turn off all 3G data connection, tap **Off**. The mobile computer will thus be limited to 2G networks if data connection is enabled.

2G DATA CONNECTION

To manually turn on/off 2G mobile data connection:

- 1) Tap **Home**  | **Settings**  | **More...**  | **Mobile networks**.
- 2) On the **Network settings** page, tap **3G service**.
- 3) Tap **Network Mode** to adjust the network mode.
- 4) Select the network mode between **2G/3G** or **3G only**.



Note: To limit data connection to 2G networks, set Network Mode to **2G/3G**, and set Enable 3G to **Off**.

To limit data connection to 3G networks, set Network Mode to **3G only**, and for Enable 3G, select the mobile carrier you would like to use.

4.1.4. SIM CARD SETTINGS



LOCK SIM CARD

To lock the SIM card:

- 1) Tap **Home**  | **Settings**  | **Security** .
- 2) Tap **Set up SIM card lock**.
- 3) Tap **Lock SIM card**.
- 4) Enter the PIN to enable SIM card lock. Once enabled, you are required to enter the PIN code in order to use the phone

CHANGE PIN CODE

To change the PIN code:

- 1) Tap **Home**  | **Settings**  | **Security** .
- 2) Tap **Set up SIM card lock**.
- 3) Tap **Change SIM PIN**.
- 4) Enter your old PIN code to confirm your identity, and then input a new PIN code.

4.2. USE WIRELESS LOCAL AREA NETWORK (WI-FI)

4.2.1. POWER ON/OFF WI-FI

To power on Wi-Fi:

- 1) Tap the Wi-Fi icon on the power control widget.



OR

- 1) Tap **Home**  | **Settings** .
- 2) Tap the Wi-Fi switch to turn on Wi-Fi power.

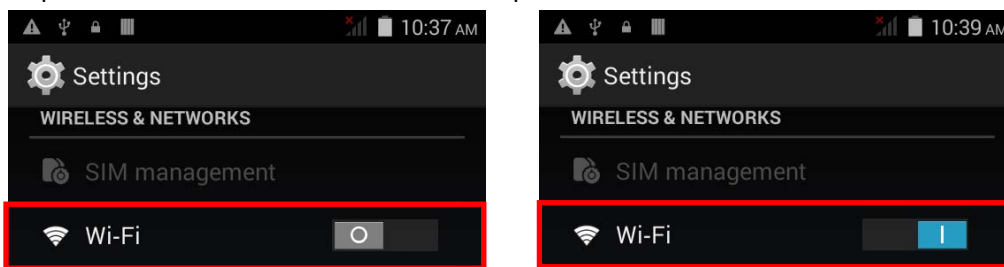

Tap the switch once more to turn off Wi-Fi power.

4.2.2. CONNECT TO WI-FI NETWORK

To connect to a Wi-Fi network:

- 1) Tap **Home**  | **Settings**  | **Wi-Fi** .

The Wi-Fi screen shows a list of available Wi-Fi hotspots.

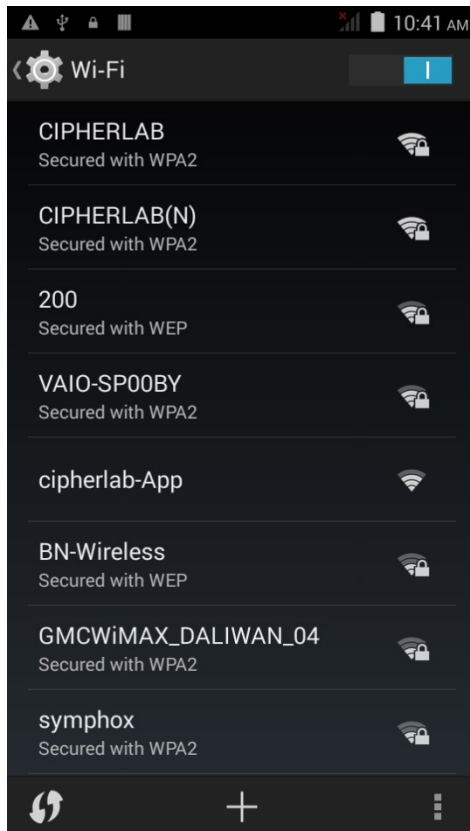

- 2) Tap the network you would like to connect to.

OR

Tap and hold the network to connect, and tap **Connect to network** in the pop-up menu.

- 3) If the network is an open one, the mobile computer will attempt to connect to it directly. When connected, the status will change to show "Connected".

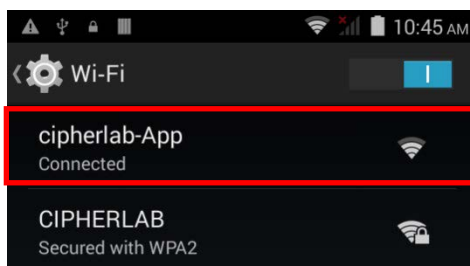

If the network is a secured one, the mobile computer prompts a dialog to enter the password for connection.

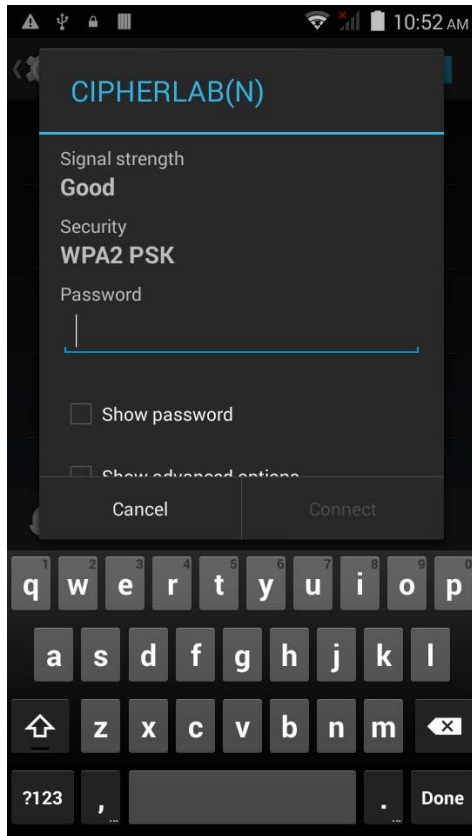

- ▶ For WEP/WPA/WPA2 PSK connections: Enter the required password and tap **Connect**.
- ▶ For 802.1x EAP connections: Check the **Show advanced options** checkbox and select the **EAP method** in the drop-down box (PEAP, TLS, TTLS, PWD, SIM, AKA), and the **Phase 2 authentication** in the drop-down box (None, MSCHAPV2, GTC). Select a **CA certificate** and **User certificate** if required (certificates may be installed under **Home** | **Settings** | **Security**.) Enter your username in the **Identity** box and the password in the **Password** box if required.

4.2.3. MANUALLY ADD WI-FI NETWORK

If the network you would like to connect to does not broadcast its SSID, or if the network is out of range, you may add it manually.

- 1) On the Wi-Fi screen, tap the add button  seated at the bottom.
- 2) In the dialog box, enter the name of the network in the **Network SSID** field, and select a security method in the **Security** field (None, WEP, WPA/WPA2 PSK, 802.1x EAP).
 - ▶ For WEP/WPA/WPA2 PSK connections: Enter the required password and tap **Save**.
 - ▶ For 802.1x EAP connections: Check the **Show advanced options** checkbox and select the **EAP method** in the drop-down box (PEAP, TLS, TTLS, PWD, SIM, AKA), and the **Phase 2 authentication** in the drop-down box (None, MSCHAPV2, GTC). Select a **CA certificate** and **User certificate** if required (certificates may be installed under **Home | Settings | Security**.) Enter your username in the **Identity** box and the password in the **Password** box if required.
- 3) If necessary, select the **Proxy** server and **IPv4** settings. By default, no proxy is set and IP settings are set to **DHCP**.

4.2.4. ADVANCED WI-FI SETTINGS

To configure advanced Wi-Fi settings:

- 1) On the Wi-Fi screen, tap the settings button  seated at the bottom right.
- 2) Select **Advanced** in the pop-up menu. Available settings are as below:

Icon	Description
Network notification	Notifies when an open network is available.
Keep Wi-Fi on during sleep	Sets when to turn Wi-Fi on during sleep.
Scanning always available	Allows location discovering applications to search for the device even when Wi-Fi is off.
Install certificates	Installs certificates recently downloaded or placed on the internal storage.
Wi-Fi optimization	Minimizes battery usage when Wi-Fi is on.
MAC address	Displays the MAC address of the device when connecting to Wi-Fi networks.
IPv6 address	Displays the IPv6 address of the device.
IPv4 address	Displays the IPv4 address of the device.

4.2.5. CONFIGURE PROXY SERVER

A proxy server acts as an intermediary between an endpoint device and another server from which the device is requesting a service.

To change the proxy settings for a connection:

- 1) Tap a network in the available Wi-Fi hotspot list.
- 2) Check the **Show advanced options** checkbox.
- 3) Tap **Proxy** and select **Manual** in the pop-up menu.
- 4) Enter the address of the proxy server in the **Proxy hostname** field. Enter the port number for the proxy server in the **Proxy port**. Enter the addresses of websites which are allowed to bypass the proxy server in the **Bypass proxy for** field. (Use the separator | between addresses.)
- 5) Tap **Connect**.

4.2.6. USE STATIC IP ADDRESS

By default, the device uses DHCP to assign an IP address when connecting to a wireless network. You may set for the device to connect to a network using a static IP address.

- 1) Tap a network in the available Wi-Fi hotspot list.
- 2) Check the **Show advanced options** checkbox.
- 3) Tap **IPv4 settings** and select **Static** in the pop-up menu.
- 4) Enter the IP address, gateway, network prefix length, DNS 1 address and DNS 2 address in the fields provided.
- 5) Tap **Connect**.

4.2.7. CONNECT WITH WI-FI PROTECTED SETUP (WPS)

Wi-Fi protected setup (WPS) allows easy establishment of a secure wireless network. The mobile computer supports WPS through push button configuration.

- 1) On the Wi-Fi hotspot scanning screen, tap the WPS button .
- 2) A dialog will pop-up on the screen showing the remaining time allowed for pressing the WPS button on the router.

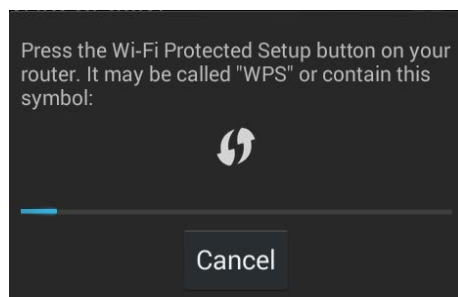

- 3) On your wireless router, press the WPS button. The device will connect to your router.

4.2.8. MODIFY WI-FI NETWORK

To change the settings for a connected network:

- 1) Tap and hold a connected network in the Wi-Fi hotspot list.

- 2) Tap **Modify network** in the pop-up menu.
- 3) In the dialog box that opens, modify the network settings, and tap **Save**.

4.2.9. DISCONNECT WI-FI NETWORK

To disconnect a connected network:

- 1) Tap and hold a connected network in the Wi-Fi hotspot list.
- 2) Tap **Forget network** in the pop-up menu.

4.3. USE BLUETOOTH

The RS30 Mobile Computer lets you configure Bluetooth settings and manage Bluetooth services provided on remote devices.

4.3.1. BLUETOOTH PROFILES

Bluetooth Profiles Supported

Generic Access Profile	(GAP)	For device discovery and authentication.
Serial Discovery Profile	(SDP)	Discovers services on remote devices.
Serial Port Profile	(SPP)	Sets up a virtual serial port to connect two Bluetooth devices.
Human Interface Device Profile	(HID)	Provides a low latency Bluetooth connection with keyboards, pointing devices, etc.
Object Push Profile	(OPP)	Pushes and pulls objects to and from a push server.
Dial-Up Networking Profile	(DUN)	Accesses the internet and other dial-up services.
Hands-Free Profile	(HFP)	Allows using a hands-free device to place and receive calls.
Advanced Audio Distribution Profile	(A2DP)	Streams stereo-quality audio to a wireless headset or speaker.
Audio/Video Remote Control Profile	(AVRCP)	Allows controlling of television and Hi-Fi equipment.
Generic Object Exchange Profile	(GEOP)	Provides a basis for other data profiles.
Personal Area Networking Profile	(PAN)	Uses Bluetooth Network Encapsulation Protocol for Bluetooth transmission.
General Audio/Video Distribution Profile	(GAVDP)	Provides a basis for A2DP and VDP.
Phone Book Access Profile	(PBAP)	Transfers Phone Book Objects to a car kit to display the information of an incoming call received on the mobile phone, or initiate a call.

4.3.2. POWER ON/OFF BLUETOOTH

To power on Bluetooth:

- 1) Tap the Bluetooth icon on the power control widget.

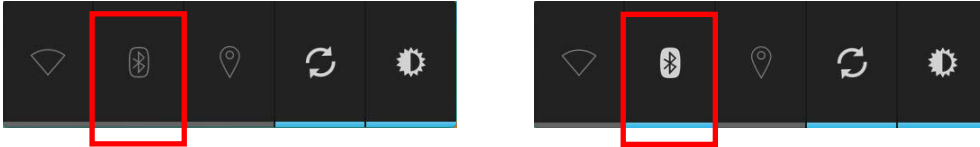

OR

- 1) Tap **Home**  | **Settings** .

- 2) Tap the Bluetooth switch to turn on Bluetooth power.

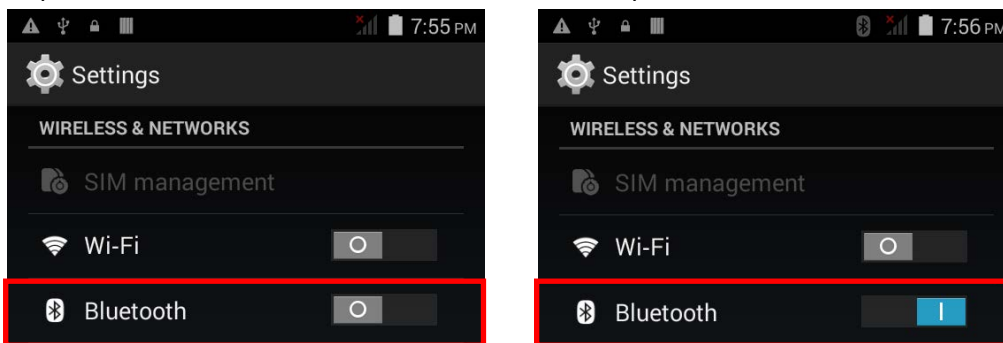



Tap the switch once more to turn off Bluetooth power.

Note: After turning on, Bluetooth power is maintained even when the mobile computer is suspended. However, if the power mode is switched to Airplane Mode, Bluetooth power will be turned off regardless of the settings.

4.3.3. SET BLUETOOTH VISIBILITY

To pair Bluetooth devices:

- 1) Tap **Home**  | **Settings**  | **Bluetooth** .
- 2) Tap **Search For Devices** at the bottom of the screen. The screen shows a list of Bluetooth devices nearby.
- 3) By default, Bluetooth visibility is turned off. Tap **ANDROID BT** at the top of the screen to turn on Bluetooth visibility. The status will change to "Visible to all nearby Bluetooth devices".

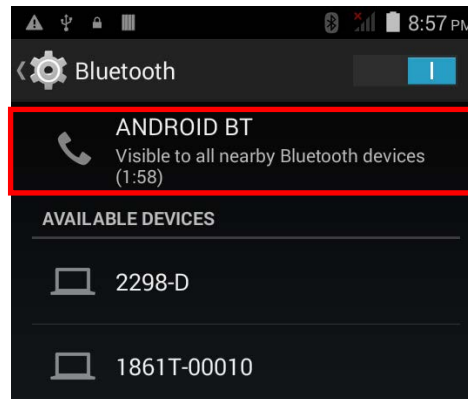
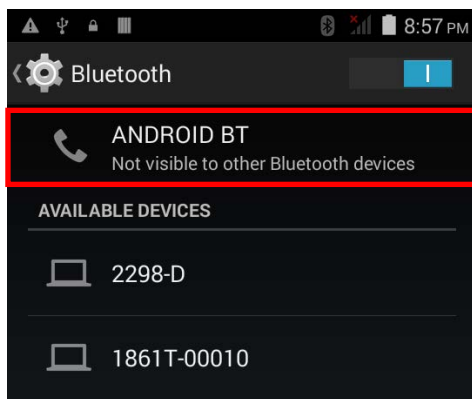

BLUETOOTH VISIBILITY TIMEOUT

To change the timeout period for Bluetooth visibility:

- 1) On the available Bluetooth devices screen, tap  in the bottom right corner.
- 2) Tap **Visibility timeout** in the pop-up menu.
- 3) Select a timeout period for Bluetooth visibility to be automatically turned off.



4.3.4. CHANGE BLUETOOTH NAME

To change the Bluetooth name to make the mobile computer more:

- 1) On the available Bluetooth devices screen, tap  in the bottom right corner.
- 2) Select **Rename phone** in the pop-up menu. Type a new name in the field and tap **Rename**.

4.3.5. PAIR BLUETOOTH DEVICE

To pair Bluetooth devices:

- 1) Tap **Home**  | **Settings**  | **Bluetooth** .
- 2) Tap **Search For Devices** at the bottom of the screen. The screen shows a list of Bluetooth devices nearby.
- 3) Scroll through the list and tap the device you would like to pair.

Note: If the device you would like to pair with is not listed, make sure Bluetooth visibility is enabled on the device.

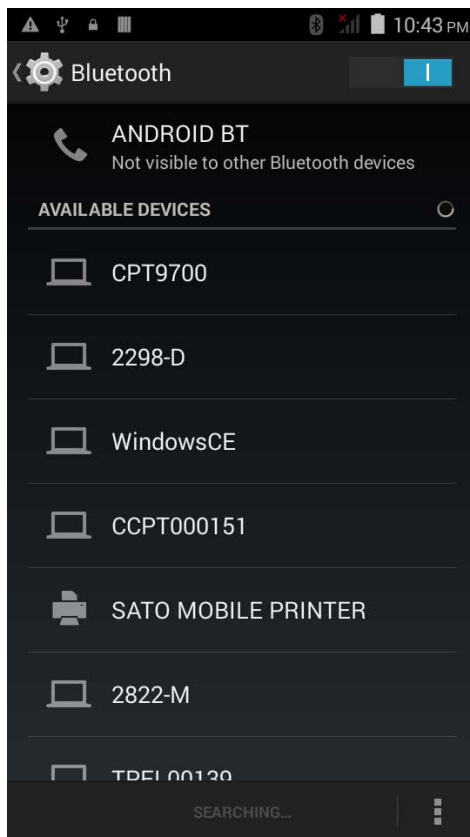

- 4) The **Bluetooth pairing request** window opens. Depending on the pairing settings of the Bluetooth device, you may need to enter a passkey, or confirm the assigned passkey on the device to pair if a smart pairing method is applied.

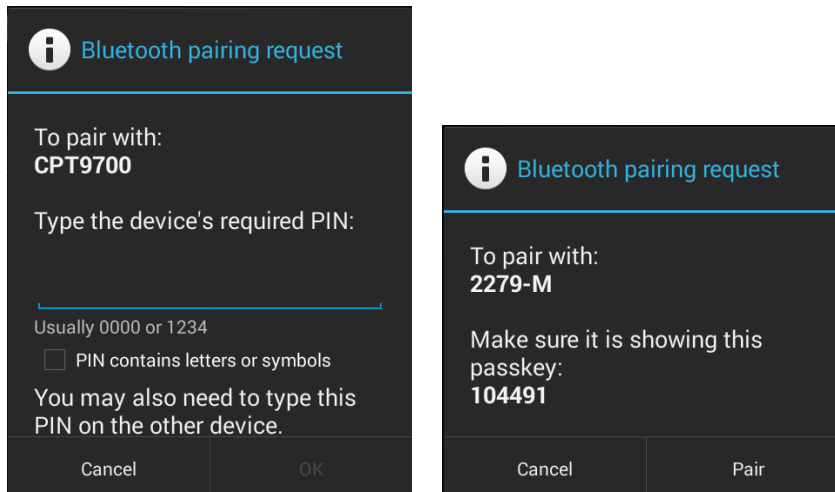

- 5) Enter/confirm the passkey on the device to pair.
6) Once pairing is done, the Bluetooth device will be listed in the **Paired Devices** list.

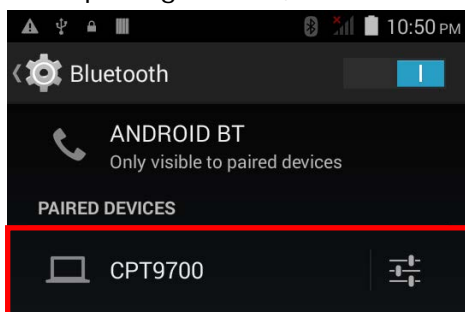

4.3.6. UNPAIR BLUETOOTH DEVICE

To unpair a paired device:

- 1) In the **Paired Devices** list, tap the settings button  next to the paired device.
- 2) On the **Paired Bluetooth device** screen, tap **Unpair**.

4.3.7. SELECT BLUETOOTH SERVICE

To select the service of a paired device:

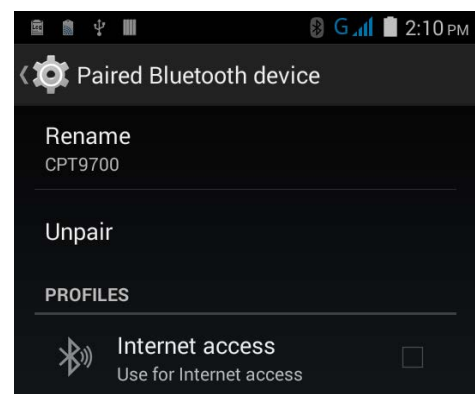

- 1) In the **Paired Devices** list, tap the settings button  next to the paired device.
- 2) On the **Paired Bluetooth device** screen, check the profile to use.



4.4. USE NEAR FIELD COMMUNICATIONS

Near field communications (NFC) uses close proximity (4 cm or less) to establish radio communication through electromagnetic fields. With NFC enabled, the mobile computer can collect information from NFC tags, exchange information with other NFC supported devices, and even change information on the NFC tag if authorized.

Before starting to communicate through NFC, perform the following:

- 1) On the mobile computer, tap **Home**  | **Settings**  | **More....**
- 2) On the Wireless & networks page, make sure the **NFC** switch is enabled.

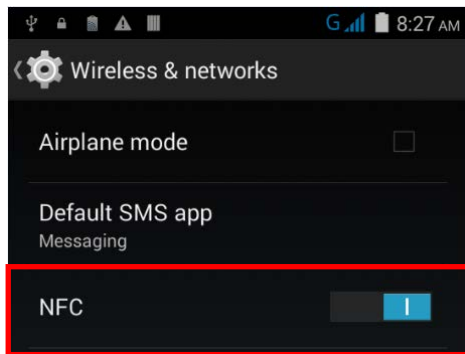

- 3) Tap the **NFC** label to enter the NFC settings page, and tap **Android Beam**.

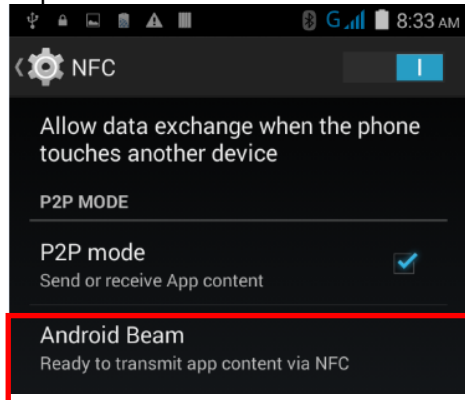

- 4) Make sure the **Android Beam** switch is enabled.

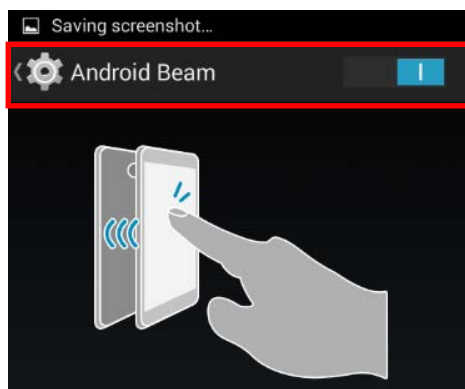

PAIR WITH NFC ENABLED BLUETOOTH DEVICES

- 1) On the device you would like to pair with, make sure NFC is enabled and Bluetooth discovery is enabled.

- 2) Hold the mobile computer without covering the antenna area at the lower end of the battery cover.

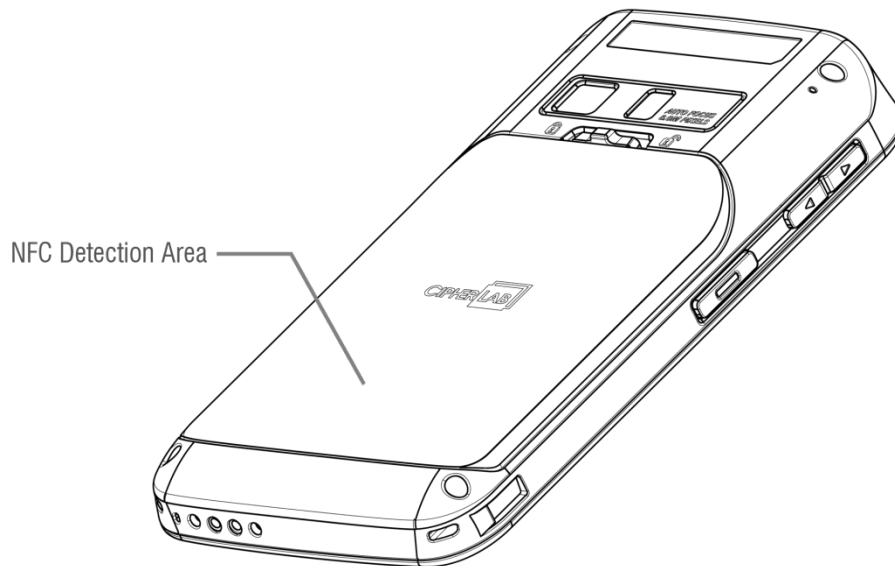

- 3) Move the mobile computer in proximity with the device. A screen notification will appear to indicate that pairing is successful.

SHARE INFORMATION

- 1) Open the web page, video, photo or contact info page you would like to transfer.
- 2) Place the back of the mobile computer in close proximity with the other device you would like to share data with.
- 3) When the two devices connect, a "Touch to beam" notification will appear on the screen.
- 4) Touch the screen to initiate data transfer.

Note: Once the data begins to transfer, the two devices only need to be held within a 10 m (32.8 ft.) range; they no longer have to be held within close range in order to transfer successfully.

COMMUNICATION WITH NFC

- 1) On the mobile computer, launch an NFC enabled application.
- 2) Hold the mobile computer without covering the antenna area at the lower end of the battery cover.
- 3) Place the mobile computer close to the NFC tag or device until the application indicates data transfer is complete.

USING THE PHONE

The RS30 Mobile Computer allows making phone calls and connecting to the network over Wideband Code Division Multiple Access (WCDMA). Insert the SIM card before turning on the power. Refer to [Inserting SIM Card](#).

Note: If the SIM card is not in position, you may make emergency calls if the service is supported.

IN THIS CHAPTER

5.1 Phone Power	90
5.2 Phone Application	92



5.1. PHONE POWER

The mobile computer accommodates two SIM cards and supports dual standby of two different networks. Both networks will be monitored at the same time, and the phone will dynamically switch between the two networks during usage. Calls will be placed with either one of the networks; you cannot switch networks in the middle of a received call or placed call, or receive or place calls with both networks at the same time.

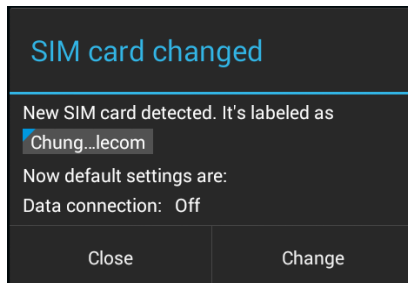
- 1) When a SIM card is installed for the first time, the phone power is turned on automatically when the mobile computer is powered on. A dialog box pops-up when the mobile computer is powered on notifying that a SIM card is detected.



Note: If only one SIM card is installed on the mobile computer, make sure it is installed in the SIM 1 card slot. See [Installing SIM Card, SAM Card and Memory Card](#).

- 2) Tap **Change** in the dialog box.
- 3) The **SIM management** screen opens showing the name of the mobile carrier and the current phone settings.
- 4) To open the **SIM management** screen from other screens, tap **Home**  | **Settings**  | **SIM management** .

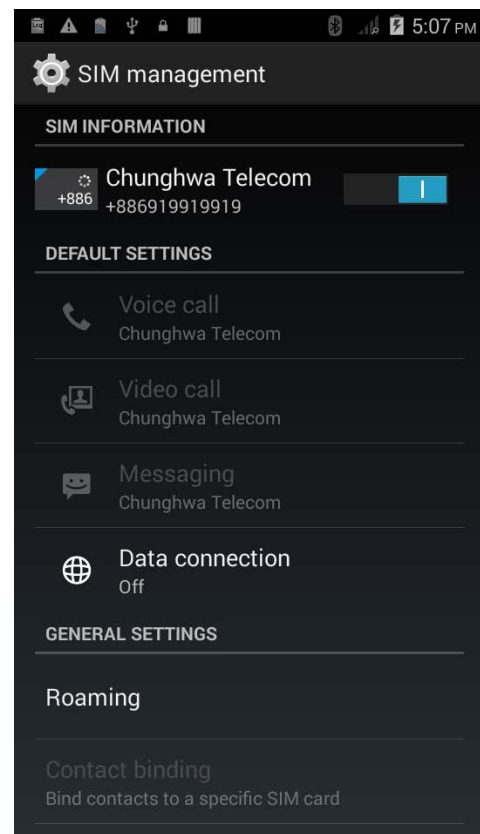

5.1.1. TURN ON/OFF PHONE POWER

To power on the phone:

- 1) On the **SIM management** screen, tap the phone power switch to turn it on.

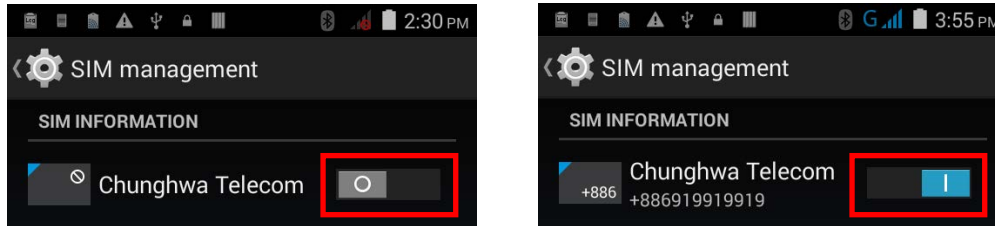

Tap the switch once more to turn off Wi-Fi power.

5.1.2. SIM CARD MISSING

If either one of the SIM card slots is empty, a warning icon will be displayed on the status bar.



Open the Notifications list to check the notification.

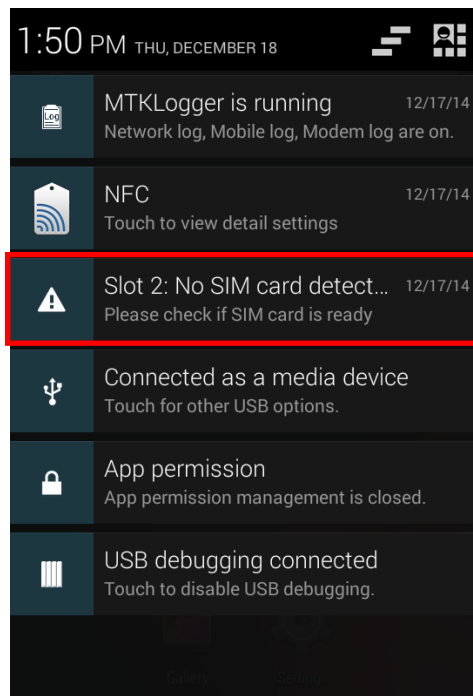

EMERGENCY CALLS

Depending on your service provider, the mobile computer might support making emergency phone call when the SIM card is locked, or even when no SIM card is inserted. Emergency phone numbers will vary by country.

5.2. PHONE APPLICATION

5.2.1. PHONE INTERFACE

- 1) When a SIM card is installed on the mobile computer and the [Phone Power](#) is on, a signal icon appears on the status bar. The number of bars indicates the strength of the connection.

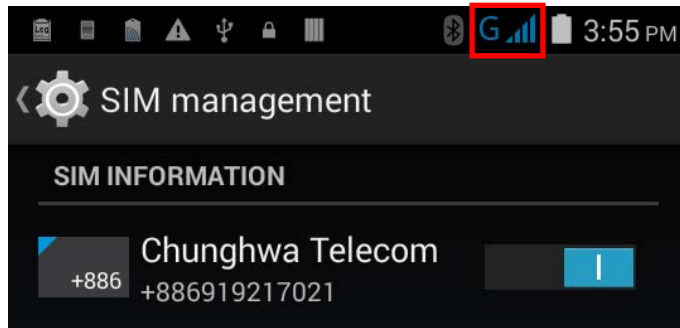

- 2) Tap **Home**  | **Phone**  . The Phone application opens.

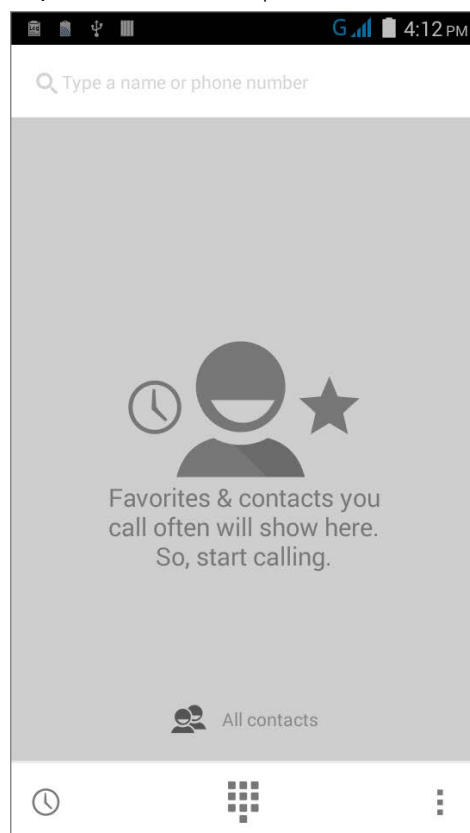

- 3) Tap the settings button  to open the phone settings menu for adding a new contact, opening the People application, or configuring [Phone Settings](#).

New contact
People
Settings

- 4) Tap  to open the dial pad.

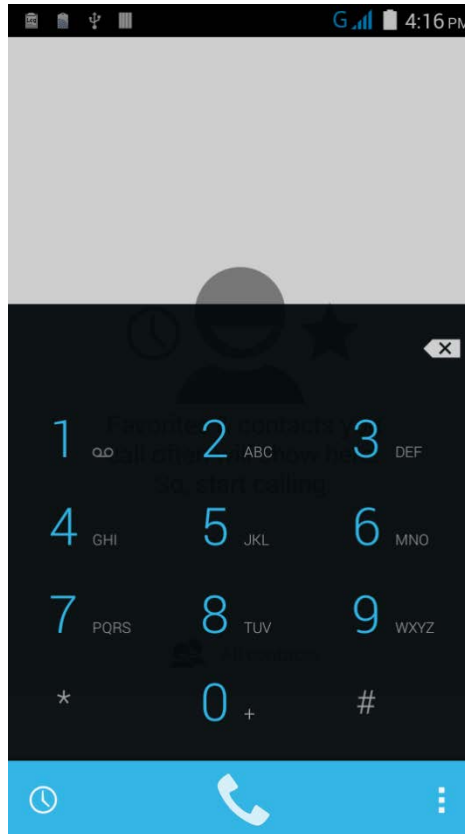
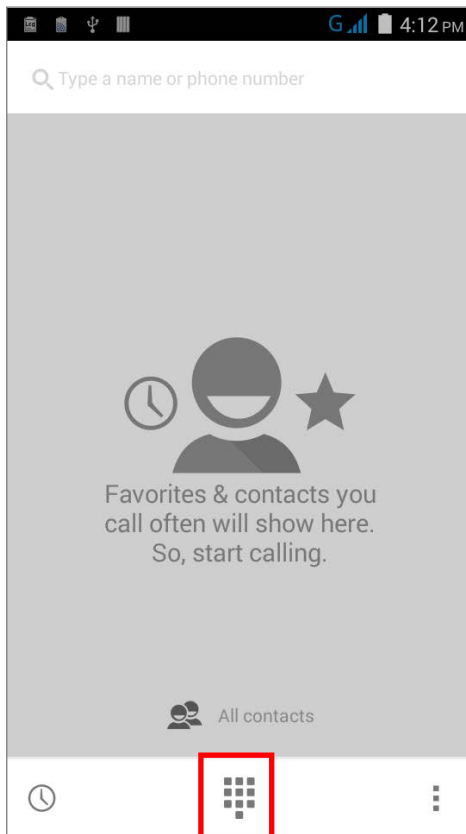

- 5) Tap  to open the dialer menu for setting speed dial numbers and opening the People application.

Speed Dial



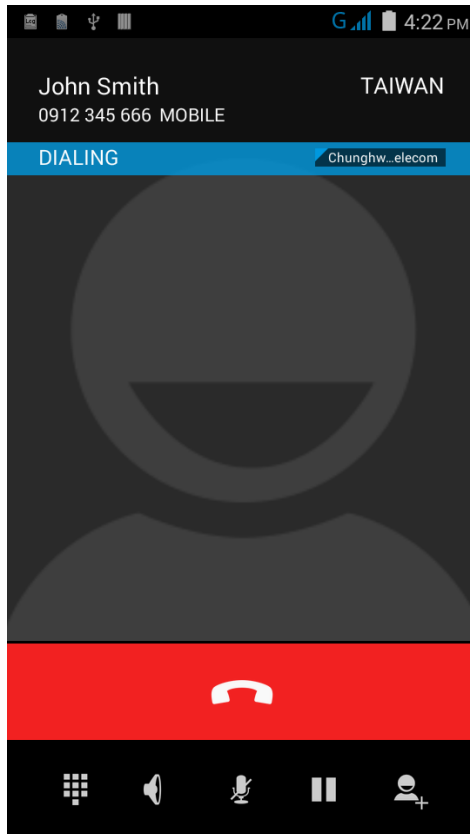

People

5.2.2. PLACE CALL

Enter the phone number in the dial pad and tap  to initiate the call.



The phone keypad features the following buttons:

Button	Description
	Opens the dial pad.
	Turns on the speaker.
	Mutes the call.
	Places the call on hold.
	Adds another person to the call.

PLACE CALL USING CONTACTS

To make a call using contacts:

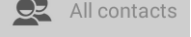
- 1) In the phone application page, tap .
- 2) Tap a contact to initiate a call.

5.2.3. RECEIVE INCOMING CALL

When a call is incoming on the mobile computer, tap



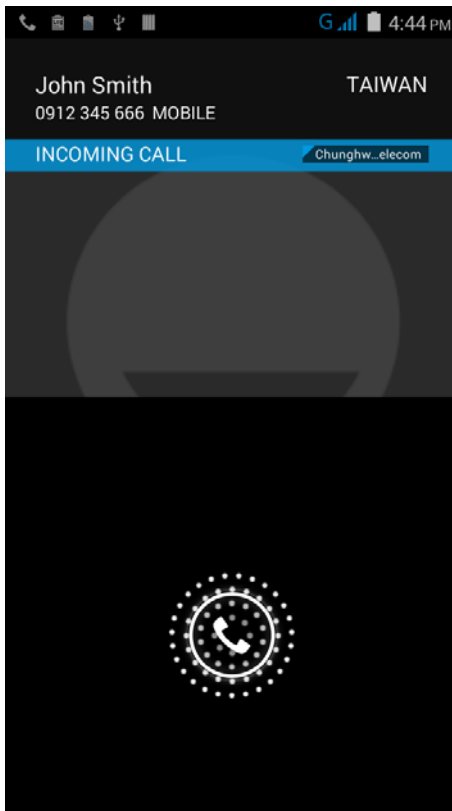

to pick it up.



Incoming calls will be recorded in the **Phone** application; in the case of a missed call, a notification will be displayed. See [Check Missed Calls](#).

To mute the ringtone of an incoming call, press the volume down button.

5.2.4. CHECK MISSED CALLS

If you have a missed call, a notification icon  will appear on the status bar, and a missed call icon  will appear on the lock screen. The LED on the top of the screen will also blink red for notification. Unlock the screen and use the [Notifications Panel](#) to manage the missed call.

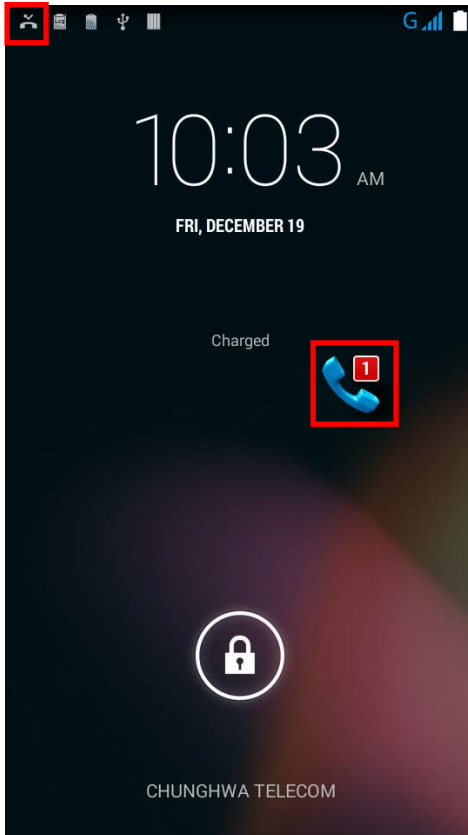



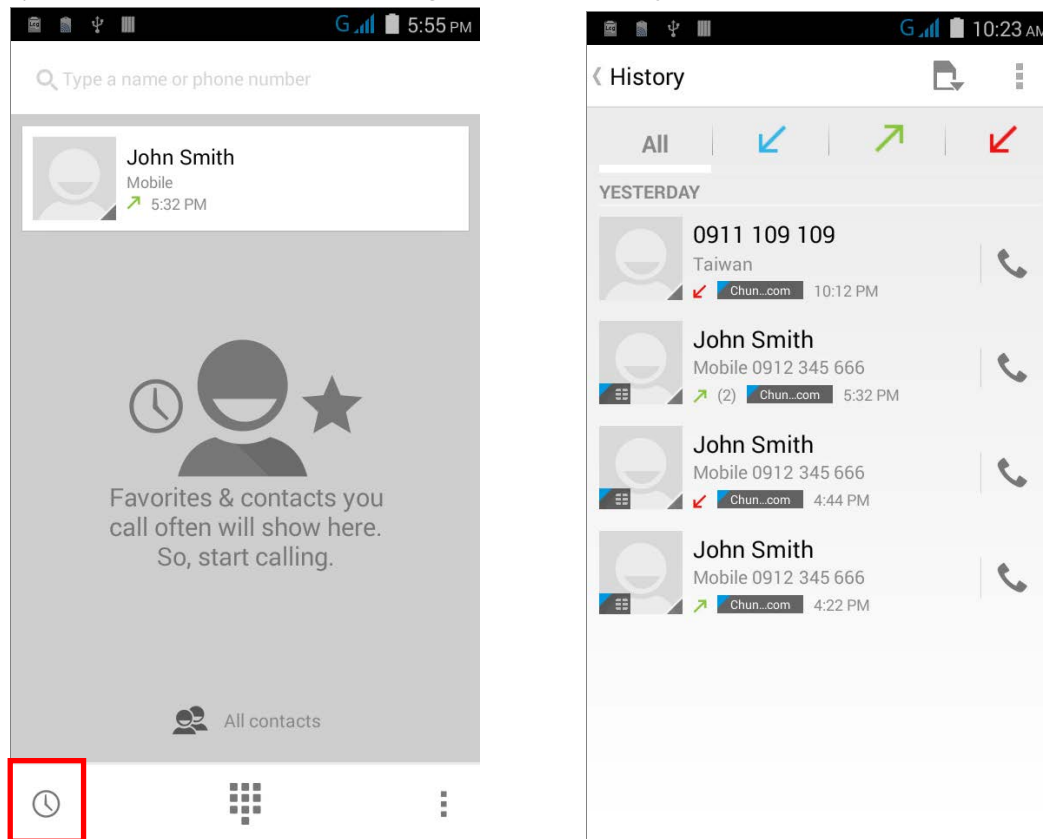

5.2.5. VIEW CALL HISTORY

1) On the Phone application page, tap the History button  to open a list of history calls.











2) Use the tabs at the top of the screen to sort out the type of call.

Button	Description
All	Lists all call history records.
	Lists received calls.
	List outgoing calls.
	Lists missed calls.

3) Tap the phone icon  next to a call record to place back the call.

5.2.6. MAKE MULTI-PARTY CALLS

To make multi-party conference calls:

- 1) On the Phone application page, enter the first number to call and tap  to initiate the call.
- 2) After the call has begun, tap  to add another member. The first call will be put on hold.
- 3) Enter the second number to call and tap  to initiate the call.
- 4) When the second call is connected, the first call will continue to be on hold. Tap the merge call button  to add the first call to the conversation. A three-party conference call is initiated.
- 5) To add a fourth member, tap . The three-party call will be put on hold.
- 6) Enter another number to call and tap  to initiate the call.
- 7) When the call is connected, the three-party call will continue to be on hold. Tap the merge call button  to add the three-party call to the conversation. A four-party conference call is then initiated.
- 8) Tap **Manage Conference** to view all members of the call.
To remove a member, tap  next to the member.
To speak with a member in private, tap the member, and the conference call will be put on hold. Tap  to return back to the conference call.

5.2.7. AUDIO MODES

The mobile computer offers three different audio modes for phone calls:

HANDSET MODE

This is the default audio mode which uses the receiver above the touchscreen for audio output during calls.

SPEAKER MODE

This mode uses the built-in speaker for audio output during calls.

HEADSET MODE

Connect a Bluetooth headset or a wired headset to the mobile computer for audio output during calls.

USE BLUETOOTH HEADSET

See [Pair Bluetooth Device](#) to connect the mobile computer to a Bluetooth device. The speaker phone becomes muted when a Bluetooth headset is connected.

USE WIRED HEADSET

Insert a wired headset in the [Headset Jack](#). The speaker phone becomes muted when a wired headset is connected.

5.2.8. IN-CALL VOLUME

Use the [Volume Buttons](#) to adjust the ringer volume and system sound level. When in the middle of a call, use the volume buttons to adjust in-call conversation volume.

5.2.9. PHONE SETTINGS

To open phone settings, tap the settings button  to on the phone application.

Indicator	Status	Description
Voice Call	Voicemail	Sets the carrier for voicemail service and the number for voicemail.
	IP prefix number	Sets prefix number for IP dial.
	Call forwarding	Sets when to forward calls.
	Call barring	Sets which types of outgoing and incoming calls to restrict, and the password for call barring.
	Additional settings	Sets whether to display caller ID in outgoing calls, or show new incoming calls during an existing call.
Video Call	Local video replacement	Sets a picture to display when the camera is off use.
	Display peer video	Sets whether to display a replacement picture when the peer video is unavailable.
	Peer video replacement	Sets the picture to display when the peer video is unavailable.
	Enable back camera	Sets to enable the back camera for video calling.
	Bigger Peer video	Sets the peer video at a larger size than the local video.
	Auto drop back	Sets to drop back voice call connecting automatically.
	Outgoing video call	Sets to display the local video when initiating a video call.
	Video incoming call	Sets to display the local video when accepting an incoming call.
	Call forwarding	Sets the call forwarding settings for video calls.
	Call barring	Sets the call barring settings for video calls.
	Additional settings	Sets phone number and call waiting settings for video calls.
Internet Call	Accounts	Sets to receive incoming calls, and adds an account for internet calling.
	Use Internet calling	Enables internet calling.
Other Settings	Fixed Dialing Numbers	Enables fixed dialing numbers (FDN), PIN2 and the phone number list for FDN.
	Minute reminder	Enables a reminder at the 50 th second of every minute.
	Quick responses	Sets a quick response for rejecting incoming calls.

	TTY mode	Sets teletypewriter (TTY) mode.
	International dialing assist	Enables international dialing assistance

USING READER CONFIGURATION UTILITY

The **Reader Configuration utility** allows you to manage the barcode reader integrated on the mobile computer.

IN THIS CHAPTER

6.1 Configure Reader	104
6.2 Read Printed Barcodes	124

6.1. CONFIGURE READER

The mobile computer is capable of reading printed barcodes. The reader module can be either a (laser) 1D reader or a 2D imager. The mobile computer is installed with a CipherLab utility Reader Config to configure the scan engine built inside. Use it to create a profile of settings that best suits your needs.

LAUNCH READER CONFIG

To launch Reader Config:

- 1) Tap **Home**  | **Apps**  | **Reader Config**  to open the Reader Configuration Utility.

OR

Tap the Reader Config shortcut on the dock.



Reader Config launches in context with the reader module(s) on board the mobile computer. On the main settings page are three sections: **General Settings**, **Symbology** and **Miscellaneous**.

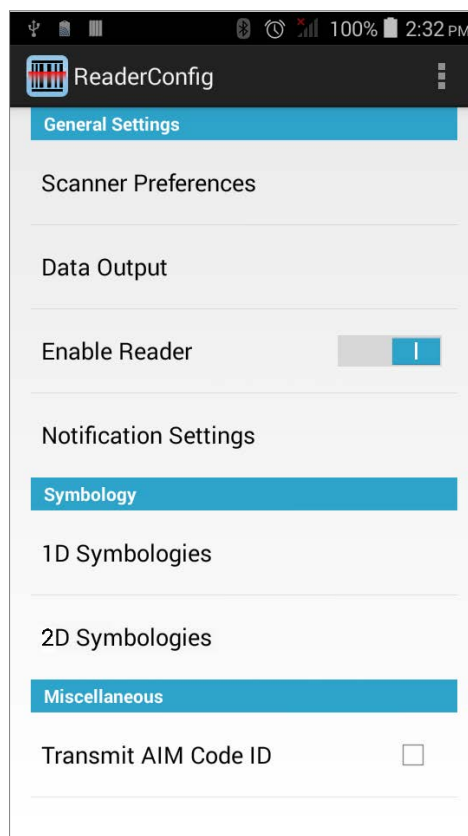

The following will guide to settings provided in each of the three sections.

6.1.1. GENERAL SETTINGS

General Settings is where all reader settings are accessed from. Tap each item to enter its sub-menu.

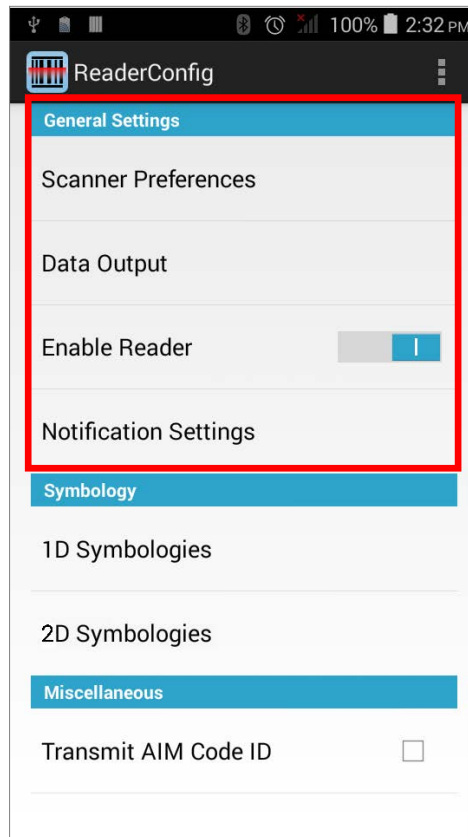

The functions under **General Settings** include:

- ▶ Scanner Preferences
- ▶ Data Output
- ▶ Enable Reader (enabled by default)
- ▶ Notification Settings

SCANNER PREFERENCES

Options on the **Scanner Preferences** page differ according to the type of scan engine built within the mobile computer.

To open **Scanner Preferences** page:

- 1) Open **Reader Config** as described in [Launch Reader Config](#).
- 2) Tap **Scanner Preferences**.

Featured settings are different for the 1D linear imager, 1D (laser) reader and 2D imager:

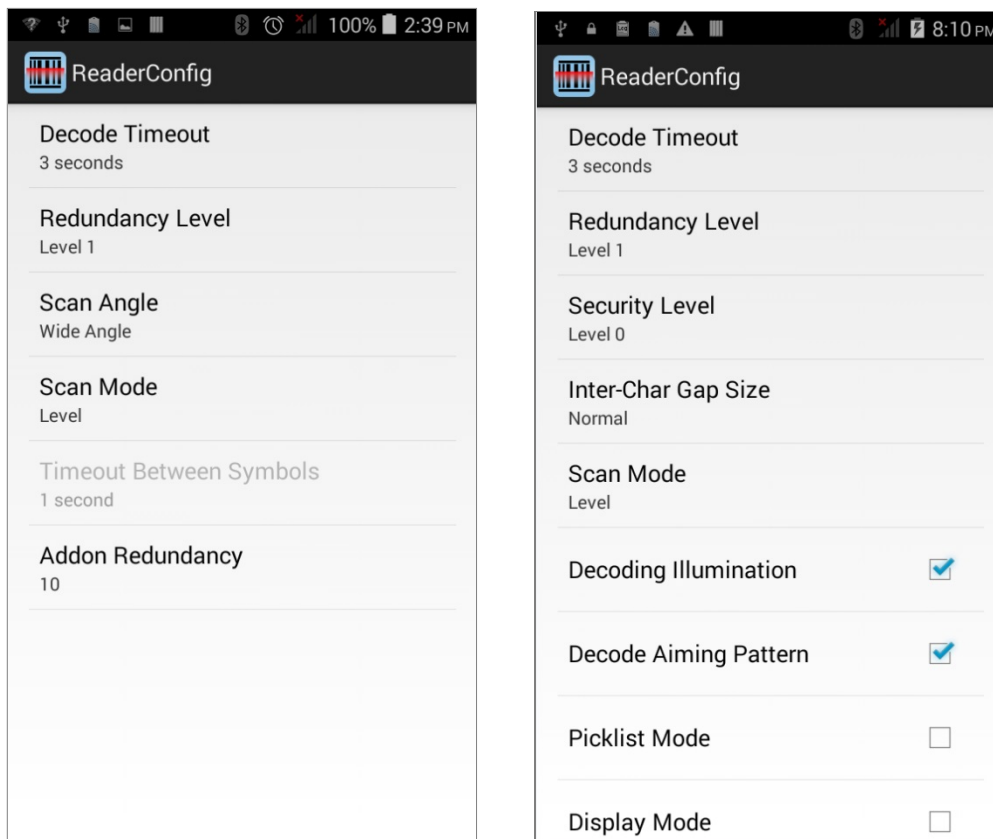

1D LINEAR IMAGER SETTINGS

Setting	Description	Default										
Decode Timeout	Sets the maximum time (configurable from 1 to 9 sec) for the decoding process during a scan attempt.	3 sec										
Redundancy Level	<p>Sets how many successful readings should be done before linear barcodes such as Codabar, MSI, and Interleaved 2 of 5 can be decoded. Levels 1 to 4 available.</p> <p>The readings needed for each level are as follows:</p> <table border="1"> <thead> <tr> <th>Level</th> <th>Description</th> </tr> </thead> <tbody> <tr> <td>1</td> <td>The following barcodes must be successfully read twice before being decoded: Codabar, MSI, Industrial 25 (Discrete 25), Interleaved 25.</td> </tr> <tr> <td>2</td> <td>All barcodes must be successfully read twice before being decoded.</td> </tr> <tr> <td>3</td> <td>All barcodes must be successfully read twice before being decoded, except for the following which must be read three times: MSI, Industrial 25 (Discrete 25), Interleaved 25.</td> </tr> <tr> <td>4</td> <td>All barcodes must be successfully read three times before being decoded.</td> </tr> </tbody> </table>	Level	Description	1	The following barcodes must be successfully read twice before being decoded: Codabar, MSI, Industrial 25 (Discrete 25), Interleaved 25.	2	All barcodes must be successfully read twice before being decoded.	3	All barcodes must be successfully read twice before being decoded, except for the following which must be read three times: MSI, Industrial 25 (Discrete 25), Interleaved 25.	4	All barcodes must be successfully read three times before being decoded.	Level 1
Level	Description											
1	The following barcodes must be successfully read twice before being decoded: Codabar, MSI, Industrial 25 (Discrete 25), Interleaved 25.											
2	All barcodes must be successfully read twice before being decoded.											
3	All barcodes must be successfully read twice before being decoded, except for the following which must be read three times: MSI, Industrial 25 (Discrete 25), Interleaved 25.											
4	All barcodes must be successfully read three times before being decoded.											
Scan Mode	<p>Sets the reader's scanning behavior.</p> <ul style="list-style-type: none"> ▶ "Continuous" to decode the same barcode repeatedly or decode different barcodes in a continuous motion. ▶ "Level" for scanning by pressing the scan trigger. 	Level										
Timeout Between Symbols	<p>Sets the time for the barcode reader to resurrect its ability to once more decode a barcode it just decoded.</p> <ul style="list-style-type: none"> ▶ Only available for Continuous mode. 	1 sec										
Addon Redundancy	Functions when "auto-discriminate" is applied for UPC/EAN addons. Decides the number of times of supplemental decoding of the same barcode in order to count as a valid read. Configurable between 2 and 30.	10										

1D LASER READER SETTINGS

Setting	Description	Default										
Decode Timeout	Sets the maximum time for the decoding process during a scan. Configurable between 1 sec to 9 sec.	3 sec										
Redundancy Level	<p>Sets how many successful readings should be done before linear barcodes such as Codabar, MSI, and Interleaved 2 of 5 can be decoded. Levels 1 to 4 available.</p> <p>The readings needed for each level are as follows:</p> <table border="1"> <thead> <tr> <th>Level</th> <th>Description</th> </tr> </thead> <tbody> <tr> <td>Level 1</td> <td>The following barcodes must be successfully read twice before being decoded: Codabar, MSI, Industrial 25 (Discrete 25), Interleaved 25.</td> </tr> <tr> <td>Level 2</td> <td>All barcodes must be successfully read twice before being decoded.</td> </tr> <tr> <td>Level 3</td> <td>All barcodes must be successfully read twice before being decoded, except for the following which must be read three times: MSI, Industrial 25 (Discrete 25), Interleaved 25.</td> </tr> <tr> <td>Level 4</td> <td>All barcodes must be successfully read three times before being decoded.</td> </tr> </tbody> </table>	Level	Description	Level 1	The following barcodes must be successfully read twice before being decoded: Codabar, MSI, Industrial 25 (Discrete 25), Interleaved 25.	Level 2	All barcodes must be successfully read twice before being decoded.	Level 3	All barcodes must be successfully read twice before being decoded, except for the following which must be read three times: MSI, Industrial 25 (Discrete 25), Interleaved 25.	Level 4	All barcodes must be successfully read three times before being decoded.	Level 1
Level	Description											
Level 1	The following barcodes must be successfully read twice before being decoded: Codabar, MSI, Industrial 25 (Discrete 25), Interleaved 25.											
Level 2	All barcodes must be successfully read twice before being decoded.											
Level 3	All barcodes must be successfully read twice before being decoded, except for the following which must be read three times: MSI, Industrial 25 (Discrete 25), Interleaved 25.											
Level 4	All barcodes must be successfully read three times before being decoded.											
Scan Angle	<p>Sets the scan angle for laser scan engine.</p> <ul style="list-style-type: none"> ▶ Wide Angle: 47° (Extended range laser reader is fixed at Wide Angle) ▶ Narrow Angle: 35° 	Wide Angle										
Scan Mode	<p>Sets the reader's scanning behavior. Options available are Continuous and Level modes.</p> <ul style="list-style-type: none"> ▶ Continuous: Used for continuous reading of barcodes. The scan engine remains on when this mode is activated. ▶ Level: Reads a barcode when the trigger is pressed. 	Level										
Timeout Between Symbols	<p>Sets the time for the barcode reader to resurrect its ability to once more decode the barcode it just decoded.</p> <ul style="list-style-type: none"> ▶ Only applied in Continuous mode 	1 sec										
Addon Redundancy	Functions when "auto-discriminate" is applied for UPC/EAN addons. Decides the number of times of supplemental decoding of the same barcode in order to count as a valid read. Configurable between 2 and 30.	10										

2D IMAGER SETTINGS

Setting	Description	Default										
Decode Timeout	Sets the maximum time for the decoding process during a scan. Configurable between 1 sec to 9 sec.	3 sec.										
Redundancy Level	Sets how many successful readings should be done before linear barcodes such as Codabar, MSI, and Interleaved 2 of 5 can be decoded. Levels 1 to 4 available.	Level 1										
Security Level	<p>Sets the security level to ensure decoding accuracy considering the printed quality of barcodes such as Code 128, Code 93, and UPC/EAN. The higher the level is, the more security is ensured. Options are:</p> <table border="1"> <thead> <tr> <th>Level</th> <th>Description</th> </tr> </thead> <tbody> <tr> <td>0</td> <td>With this default, the scan engine is aggressive enough to decode most "in-spec" barcodes.</td> </tr> <tr> <td>1</td> <td>Select this level if misdecodes have occurred. It fixes most misdecodes.</td> </tr> <tr> <td>2</td> <td>Select this level if Level 1 should fail to eliminate misdecodes.</td> </tr> <tr> <td>3</td> <td>Select this level if Security Level 2 should fail to prevent misdecodes. However, as this level actually impairs the decoding ability of the decoder, a safer solution would be to improve the quality of the bar codes to read.</td> </tr> </tbody> </table>	Level	Description	0	With this default, the scan engine is aggressive enough to decode most "in-spec" barcodes.	1	Select this level if misdecodes have occurred. It fixes most misdecodes.	2	Select this level if Level 1 should fail to eliminate misdecodes.	3	Select this level if Security Level 2 should fail to prevent misdecodes. However, as this level actually impairs the decoding ability of the decoder, a safer solution would be to improve the quality of the bar codes to read.	Level 0
Level	Description											
0	With this default, the scan engine is aggressive enough to decode most "in-spec" barcodes.											
1	Select this level if misdecodes have occurred. It fixes most misdecodes.											
2	Select this level if Level 1 should fail to eliminate misdecodes.											
3	Select this level if Security Level 2 should fail to prevent misdecodes. However, as this level actually impairs the decoding ability of the decoder, a safer solution would be to improve the quality of the bar codes to read.											
Inter-Char Gap Size	Sets the intercharacter gap size for Code 39 and Codabar. Switch between Normal and Large .	Normal										
Scan Mode	<p>Sets the reader's scanning behavior. Options available are Level and Presentation Mode.</p> <ul style="list-style-type: none"> ▶ Level: The decoding process is activated by a trigger event, and continues until the trigger event ends, a valid decode happens or decode session time-out is reached. ▶ Presentation Mode: The imager engine attempts to decode a barcode when an object appears in its field of view. To enter this mode, select "Presentation Mode" and tap Apply. Once activated, the imager will stay on, and will only be deactivated if one of the following occurs: the trigger is pressed, or the time interval specified in Decode Timeout passes without any new object coming into its field of view. 	Level										
Decoding Illumination	Enables an LED light beam to aid barcode reading.	Selected (Enabled)										
Decode Aiming Pattern	Projects a crosshair at the center of the laser light beam to facilitate barcode reading.	Selected (Enabled)										
Picklist Mode	When selected, only barcodes aligned at the crosshair of the laser light beam will be decoded.	Deselected (Disabled)										

Display Mode	Enable improved performance for reading barcodes on electronic displays and mobile phones.	Deselected (Disabled)
Inverse Type	Decide whether to disable or enable decoding inverse barcodes, or set as auto.	Regular only
Addon Redundancy	Functions when "auto-discriminate" is applied for UPC/EAN addons. Decides the number of times of supplemental decoding of the same barcode in order to count as a valid read. Configurable between 2 and 30.	10

DATA OUTPUT

Data Output allows users to set the way to output decoded data.

To open **Data Output** settings page:

- 1) Open **Reader Config** as described in [Launch Reader Config](#).
- 2) Tap **Data Output**.

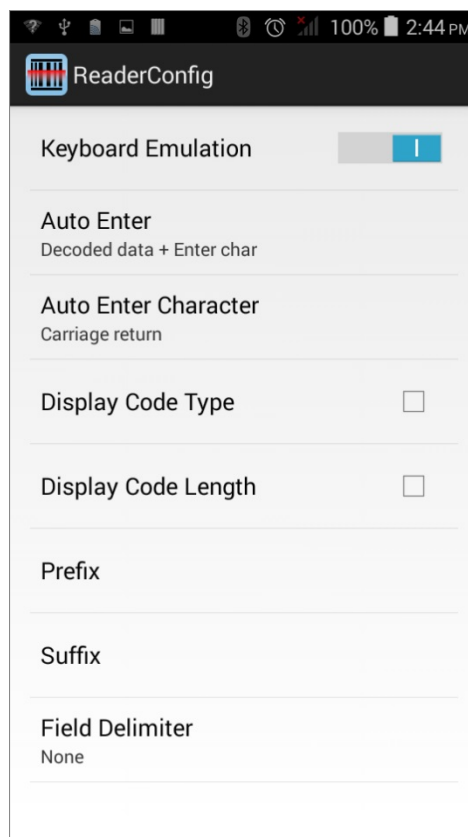

WHERE TO OUTPUT

Keyboard Emulation setting controls where the decoded data is to be output.

Setting	Descriptions	Default
Keyboard Emulation	Tap the switch to enable. When enabled, the reader module treats decoded data as typed text and outputs it to the active application on the mobile computer.	Enabled

HOW TO OUTPUT

After the output destination is set, configure how to output decoded data, i.e. the “format” to present decoded data.

Setting	Description	Default
Auto Enter	<p>Adds an ENTER character before or after each string of decoded data. The ENTER character can be defined in the “Auto Enter character” field below. This function saves the trouble of pressing a confirmation key to accept each string of decoded data. Options are:</p> <ul style="list-style-type: none"> ▶ Disable ▶ Decoded data + Enter char ▶ Enter char + Decoded data 	Decoded data + Enter char
Auto Enter character	<p>Adds a key code before or after the decoded data. If [Auto Enter] is enabled, select the ENTER character to send. Options are:</p> <ul style="list-style-type: none"> ▶ None ▶ Carriage Return ▶ Tab ▶ Space ▶ Comma ▶ Semicolon 	Carriage Return
Display Code Type	Prefixes the output data with code type information.	Deselected (Disabled)
Show Code Length	Suffixes the output data with code length information.	Deselected (Disabled)
Prefix	<p>Affixes 0 to 10 characters to the left of the output data. Tap the label to open a character table for entering the prefix.</p> <ul style="list-style-type: none"> ▶ Prefixes containing invisible characters are supported. 	--
Suffix	<p>Affixes 0 to 10 characters to the right of the output data. Tap the label to open a character table for entering the suffix.</p> <ul style="list-style-type: none"> ▶ Suffixes containing invisible characters are supported. 	--
Field Delimiter	<p>Sets the delimiter to separate the output barcode data to the following pieces: code type, decoded barcode data, and code length (if applicable). Options are:</p> <ul style="list-style-type: none"> ▶ None ▶ Comma ▶ Semicolon ▶ Full stop 	None

ENABLE READER

Features a switch to enable or disable reader scanning ability. When enabled, a light beam will be sent out from the scanning window each time the trigger (scan key) is pressed.

NOTIFICATION SETTINGS

Notification Settings enables audible, visible and tactile feedback for scanning good read, which helps notify the user of a successful decoding.

To open **Notification Settings** page:

- 1) Open **Reader Config** as described in [Launch Reader Config](#).
- 2) Tap **Notification Settings**.

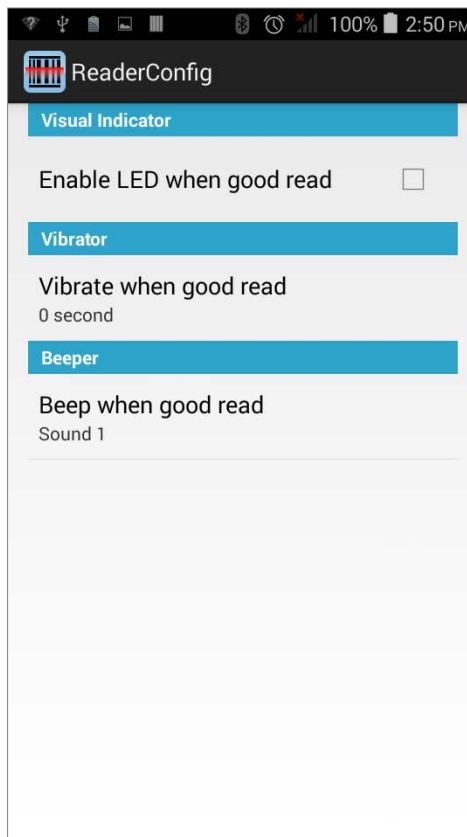

Setting		Description	Default
LED	Enable LED when good read	Selects to enable/disable LED light (left) for scanning good read. See Status LED for details.	Deselected (Disabled)
Vibrator	Vibrate when good read	Enables/disables tactile feedback (vibration) for good read and sets the duration to vibrate.	0 second (Disabled)
Beeper	Beep when good read	Sets the beeper sound for scanning good read. Users can choose to mute the beeper sound, or configure the beeper between sounds 1 to 9.	Sound 1

6.1.2. SYMBOLOGY

The **Symbology** page sets the symbologies to read, and also enables/disables some feature(s) for a symbology to read, such as:

- ▶ Customize and transmit start/stop characters
- ▶ Verify/transmit check digits
- ▶ Enable/disable addon digits
- ▶ Convert to another symbology
- ▶ Transmit symbology ID

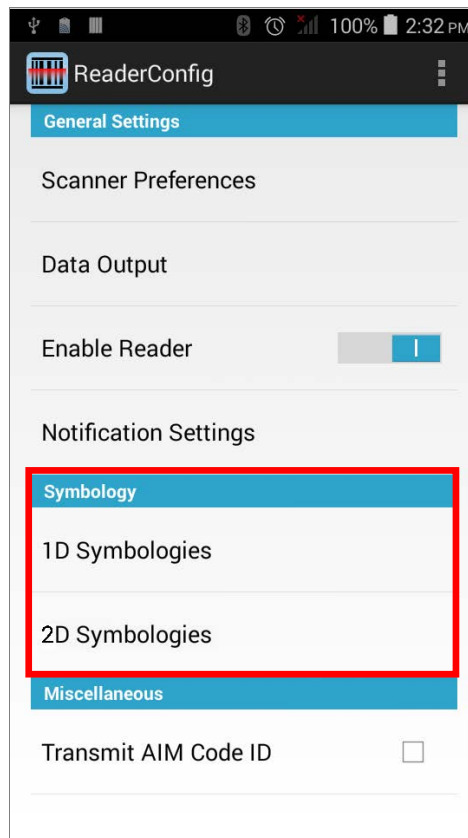

To open **Symbology** settings page:

- 1) Open **Reader Config** as described in [Launch Reader Config](#).
- 2) Tap **1D Symbologies** or **2D Symbologies** (in case of a 2D imager) to list all symbologies which can be decoded.

1D Symbologies

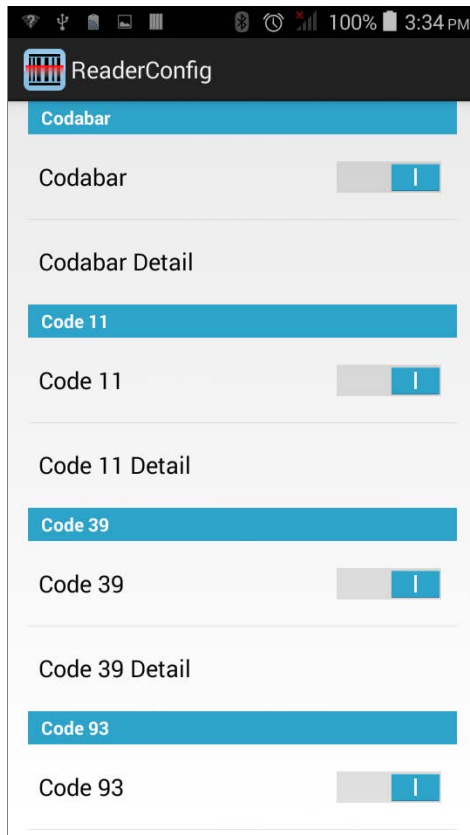

2D Symbologies

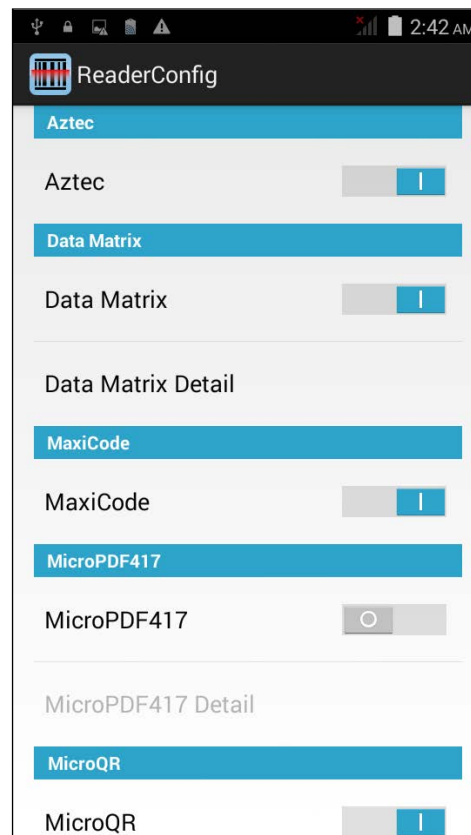

ENABLE/DISABLE SYMBOLOGY

Tap the label of each symbology to enable or disable it.

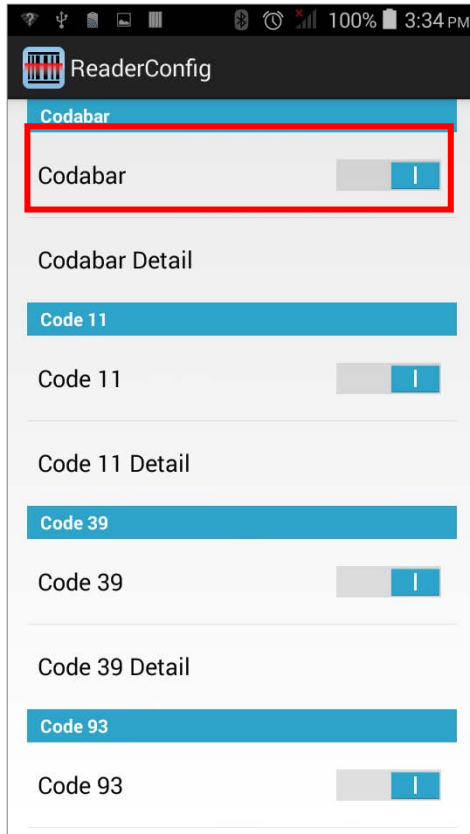
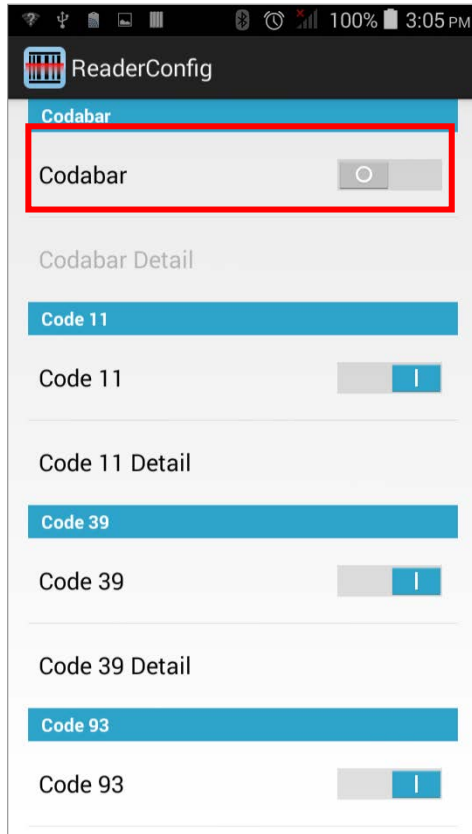

SYMBOLGY SETTINGS

Tap the **Detail** label below each symbology to access detailed settings for the specific symbology.

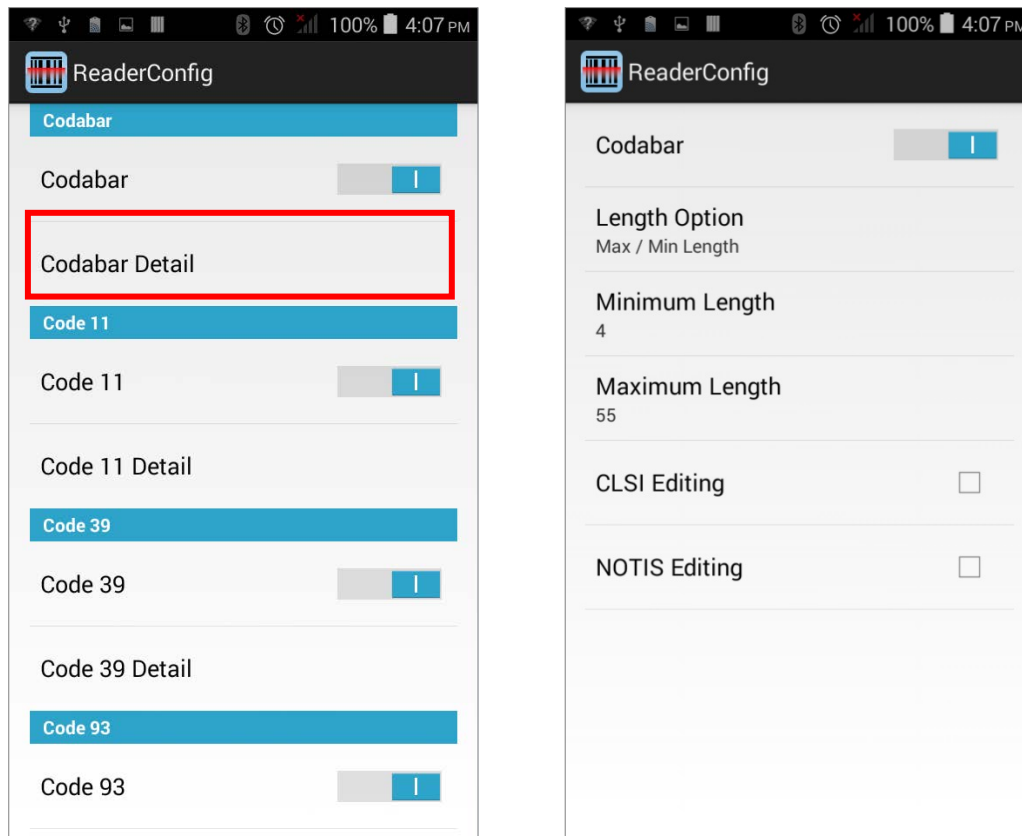

For details about the featured settings:

- ▶ See Appendix II: CCD Linear Imager [Symbology Settings](#).
- ▶ See Appendix III: Laser Reader [Symbology Settings](#).
- ▶ See Appendix IV: 2D Imager [Symbology Settings](#).

6.1.3. MISCELLANEOUS

This section allows enabling code ID transmission for easy identification of the scanned barcode.

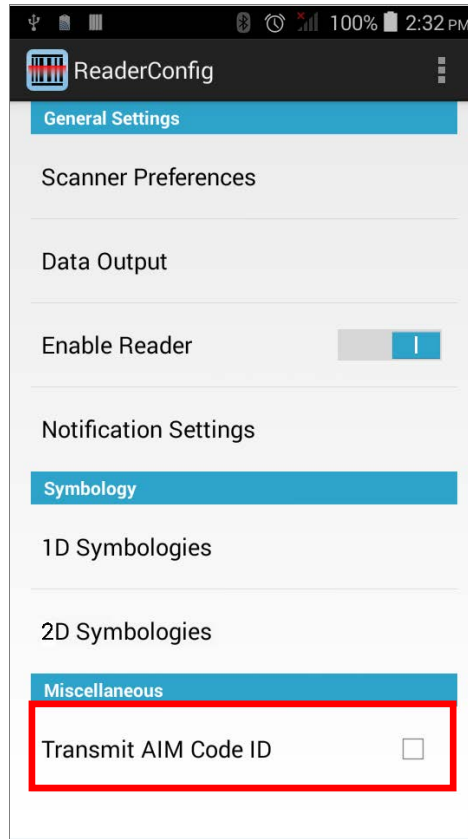

Setting	Description	Default
Transmit AIM Code ID	<p>Sets whether to include AIM code ID character in the decoded data. For AIM code ID, see the following:</p> <ul style="list-style-type: none"> ▶ Appendix II: CCD Linear Imager Symbology Settings. ▶ Appendix III: Laser Reader Symbology Settings. ▶ Appendix IV: 2D Imager Symbology Settings. 	Deselected (Disabled)

6.1.4. READER CONFIG OPTION MENU

Reader Config provides an option menu which is accessible on the menu bar of the main settings page. This menu allows you to test scan barcodes, import/export all settings in a re-usable format, reset all settings back to factory default, and view copyright and version information.

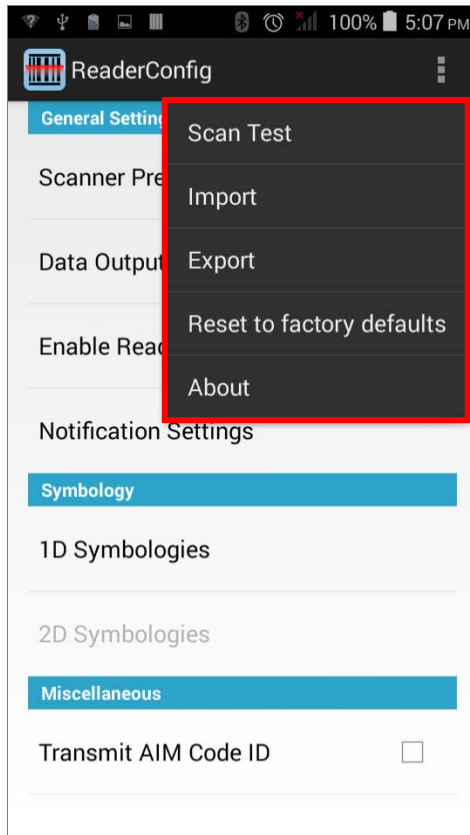

SCAN TEST

To test scan a barcode:

- 1) Open **Reader Config** as described in [Launch Reader Config](#).
- 2) Tap the settings button  on the menu bar to open the option menu.
- 3) Tap **Scan Test** in the option menu. A page opens for test scanning.

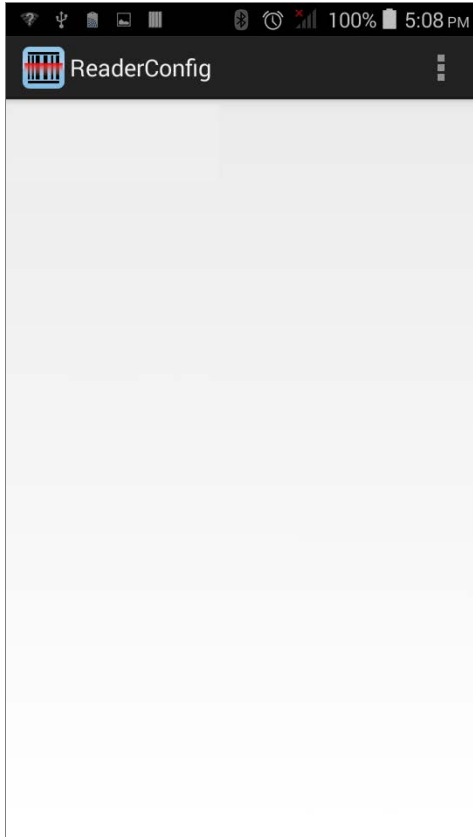

IMPORT AND EXPORT

Reader Config supports saving the settings and exporting them as an .xml file.

Previously exported symbology and scanner settings can be imported again on the mobile computer. This can also be used to implement identical Reader Config settings on multiple devices.

To import settings:

- 1) Open **Reader Config** as described in [Launch Reader Config](#).
- 2) Tap the settings button  on the menu bar to open the option menu.
- 3) Tap **Import** in the option menu.

A page opens allowing you to select a previously saved profile.

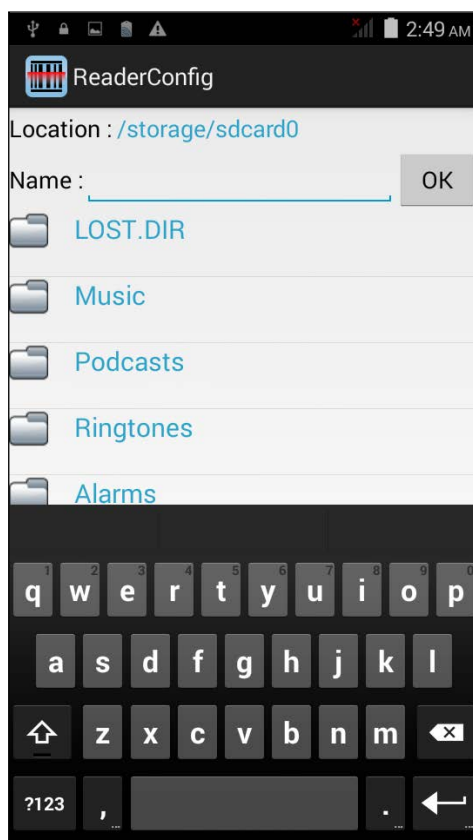

- 4) Tap **OK**. In a few seconds a prompt will appear on the mobile computer to indicate settings have been imported successfully.

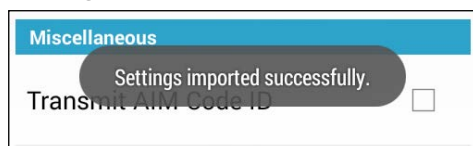

To export settings:

- 1) Open **Reader Config** as described in [Launch Reader Config](#).
- 2) Tap the settings button  on the menu bar to open the option menu.
- 3) Tap **Export**.

An export page opens allowing you to enter the name and location of the profile to save.

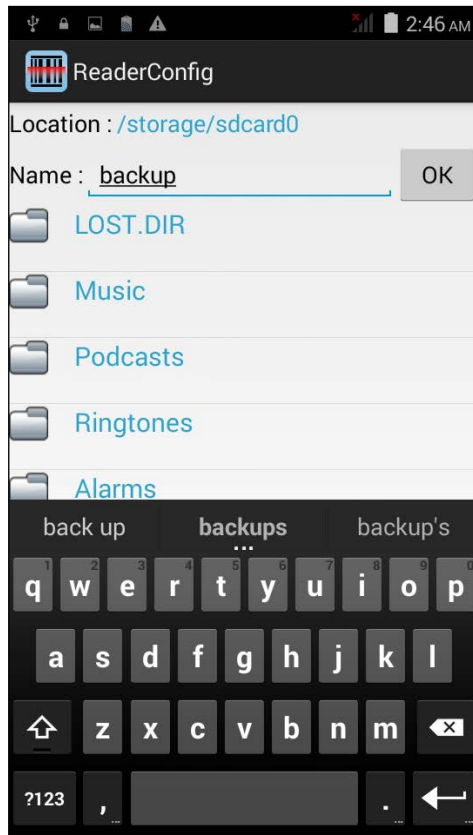

- 4) Tap **OK** to export. A prompt will appear on-screen to notify that settings have been exported.

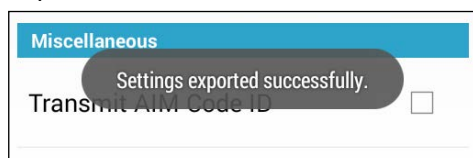

RESET TO FACTORY DEFAULTS

This function restores all settings in the **Reader Config** application to default.

To enable Factory Reset:

- 1) Open **Reader Config** as described in [Launch Reader Config](#).
- 2) Tap the settings button  on the menu bar to open the option menu.
- 3) Tap **Reset to Factory defaults**.

A warning dialog appears confirming whether to restore all application settings back to default. Tap **OK** to reset or **Cancel** to close the dialog.

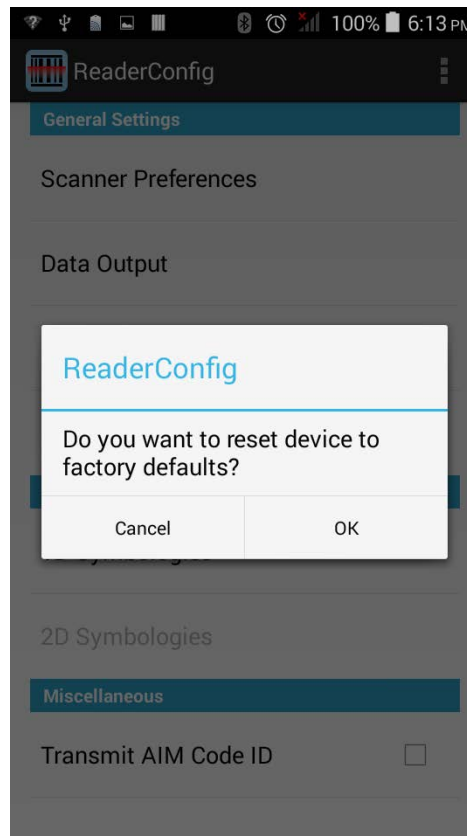
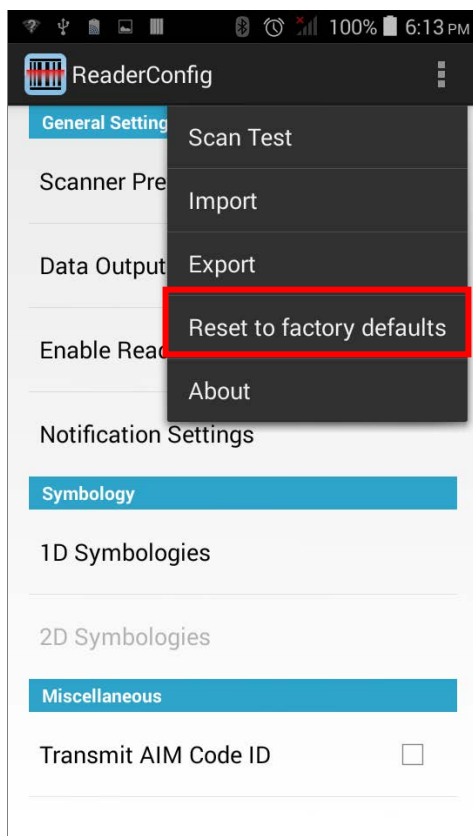

ABOUT

Tap **About** in the Reader Config option menu to display software version and copyright information.

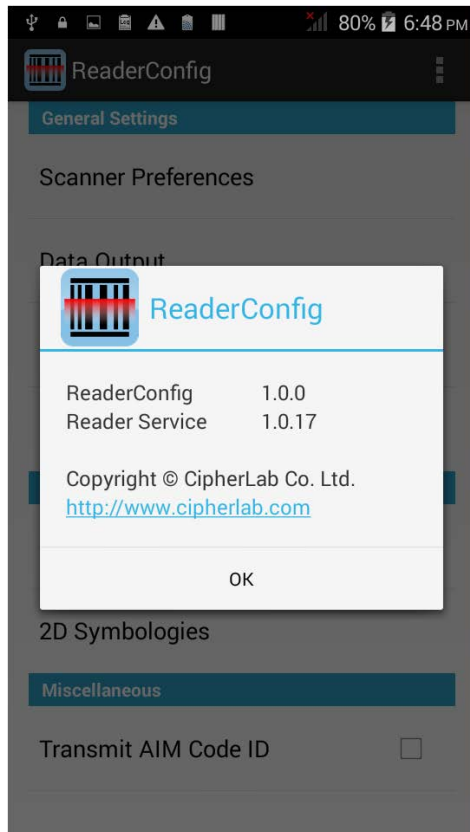

6.2. READ PRINTED BARCODES

Aside from output to destinations as per [Keyboard Emulation](#) settings, Reader Config provides a **Scan Test** feature for quick viewing of decoded data.

To perform test scanning of barcodes:

- 1) Open **Reader Config** as described in [Launch Reader Config](#).
- 2) Tap **Scan Test** on the menu bar.

A Test Scan Form opens for displaying the scanned data.

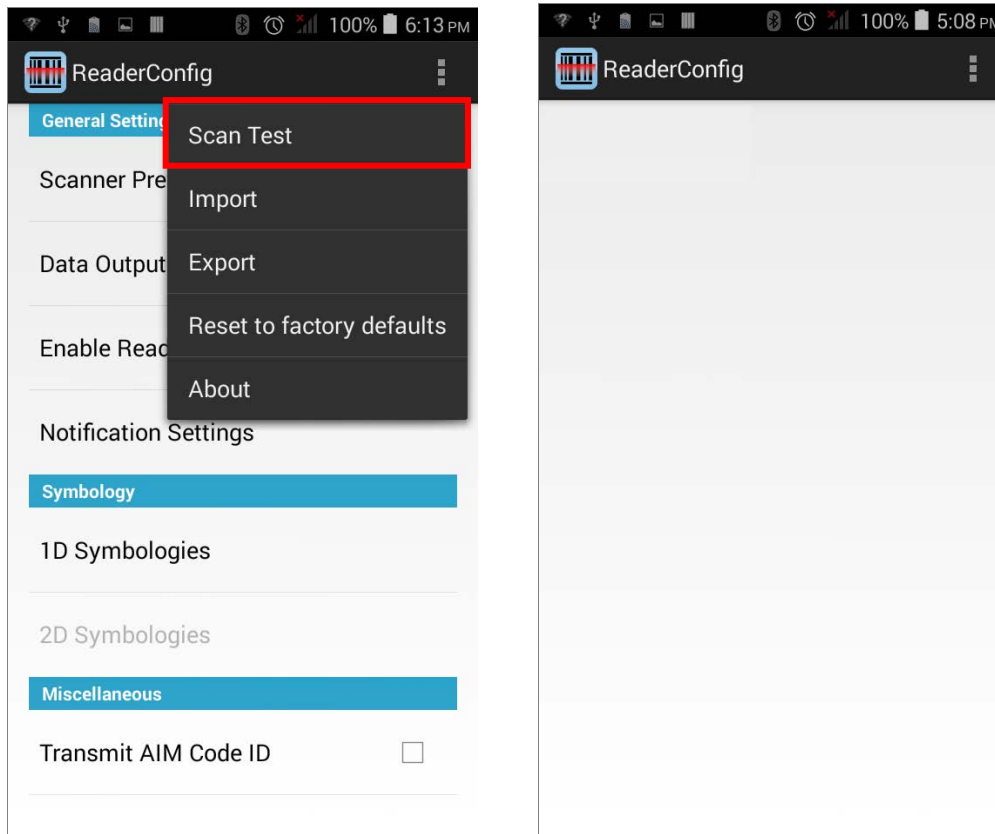

- 3) Aim the scanning window at the barcode to read and press any of the two side triggers. The scanning light beams to read the printed barcodes.

The scanning light goes off once the data is decoded, or when the decode timeout period has passed.

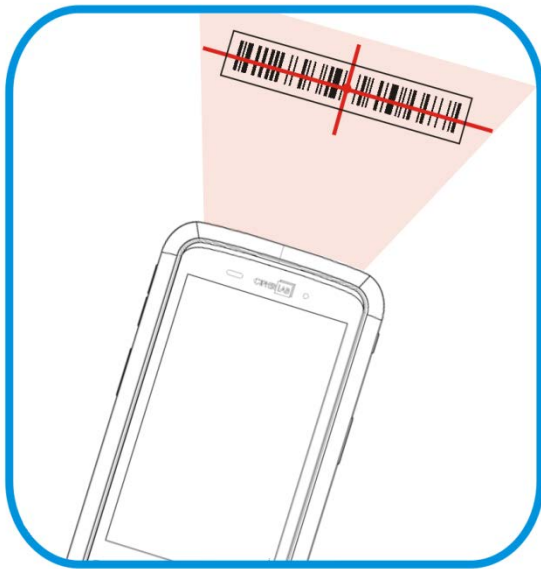

The decoded data will appear on the page. When finished viewing, tap  to leave the test scan page.

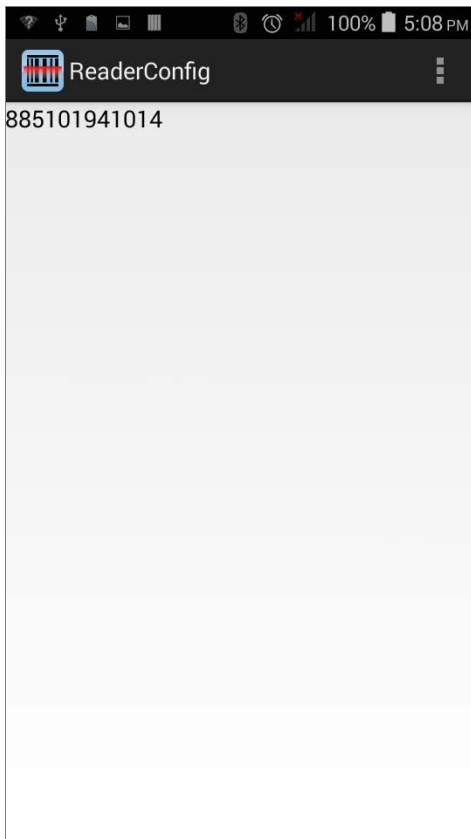

To display more information such as barcode type and length, configure the reader as in [Data Output](#).

TEST SCAN MENU

Tap the settings button  on the menu bar to save the decoded data as a .txt file or clear all data on the screen.

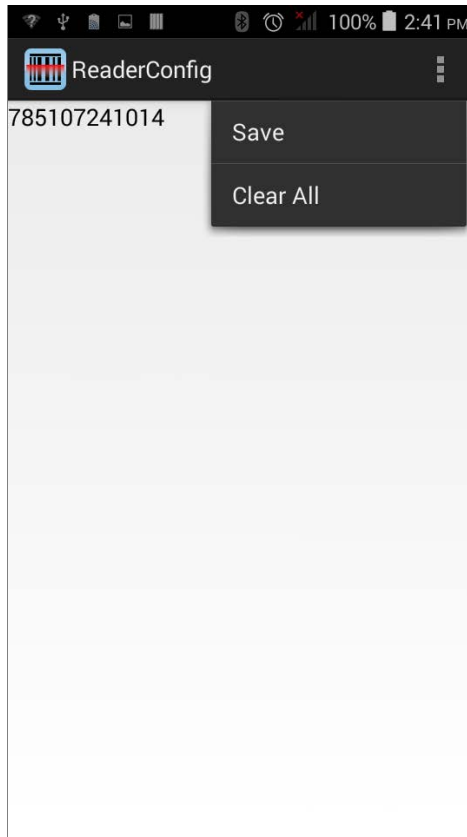

SPECIFICATIONS

PLATFORM, PROCESSOR & MEMORY

Operating System & CPU

OS Version	Android 4.4.2
CPU	Cortex 1.3 GHz Quad-Core Processor

Memory

ROM	8GB eMMC
RAM	1GB LPDDR2 RAM
Expansion Slot	One microSDHC card slot (up to 32GB) ▶ SDXC supported

COMMUNICATION & DATA CAPTURE

Communication

USB Client	USB 2.0 OTG
WPAN	Bluetooth Class II, v4.0 and v2.1+EDR
WLAN	IEEE 802.11b/g/n networking
WWAN	Built-in module for Quadband HSPA+/GSM GSM/GPRS/EDGE/WCDMA/UMTS/HSDPA/HSUPA/HSPA+ Frequency band: GSM/GPRS/EDGE: 850/900/1800/1900 WCDMA/UMTS/HSDPA/HSUPA: 850/900/1900/2100 HSPA+: 14.4 Mbps/5.76 Mbps
GPS	Built-in GPS with AGPS support, ephemeris downloadable

Data & Image Capture

Digital Camera	8 Mega pixels with user-controllable flash	
Barcode Reader	Ordering options include	<ul style="list-style-type: none"> ▶ Linear Imager (SM1) ▶ 1D Laser (SE955) ▶ 2D Imager (SE4500)
HF RFID Reader	ISO14443A/B (Mifare), ISO15693 (Felica)	
	▶ Supports NFC (Peer-to-peer, Card reader, Card emulation)	

ELECTRICAL CHARACTERISTICS

Batteries

Main Battery Pack	Rechargeable Li-ion battery: 3.7V, 2500 mAh	
	Charging time: 4 hours	
Backup Battery	Rechargeable Li-ion battery: 3.7V, 70 mAh	
	Data retention for 30 minutes	
	Charging time: 4 hours	

Power Adaptor

Power Supply Cord with	Input	AC 100~240 V, 50/60 Hz
Universal Power Adaptor	Output	DC 5V, 2A

Working Time

Supports working time for up to 8-10 hours.

PHYSICAL CHARACTERISTICS**Color Touch Screen Display**

Display	4.7" Transmissive IPS LCD, 510 NITS, Corning Gorilla Glass 3
Resolution	qHD (960 x 540 pixels)

Notifications

Status LED	Single LED which lights red when charging, green when charging is complete, and blue when wireless radio is on
Audio	Integrated with one speaker, dual array digital microphones with echo and noise cancellation

Dimensions & Weight

Dimensions	155 mm (L) x 80mm (W) x 17.3 (H)
Weight	Under 260 g (2D Reader, including battery)

ENVIRONMENTAL CHARACTERISTICS

Temperature

Operating	-20 °C to 50 °C
Storage	-30 °C to 70 °C (transmissive)
Charging	0°C to 40°C

Humidity

Operating	10% to 90% (non-condensing)
Storage	5% to 95% (non-condensing)

Resistance

Impact Resistance	With Hardshell:
	Multiple drops onto steel at 1.5 m (5 ft.) on all six sides
	Without Hardshell:
	Multiple drops onto steel at 1.2 m (4 ft.) on all six sides
Tumble Test	With Hardshell:
	500 tumbles (1000 drops) at 0.5 m per applicable IEC tumble specifications
	Without Hardshell:
	150 tumbles (300 drops) at 0.5 m per applicable IEC tumble specifications
Splash/Dust Resistance	IP54 per applicable IEC sealing specifications
Electrostatic Discharge	±15 kV air discharge, ±8 kV contact discharge

PROGRAMMING SUPPORT

Development Environment & Tools

Integrated Development Environment	Visual Studio 2008
	Visual Studio 2005
Software Development Kit	Microsoft SDK
	System API (DLL) for system configuration
	Reader API (DLL) for reader configuration

Software & Utilities

CipherLab Software Package	▶ Reader Configuration
Third-party Software	▶ Kalipso

ACCESSORIES

Accessory Options

- ▶ Hardshell
- ▶ Charging Cradle

SCAN ENGINE SETTINGS

The CipherLab developed utility **Reader Configuration** sets the following reader types:

- ▶ CCD (SM1)
- ▶ 1D Laser (SE955)
- ▶ 2D Imager (SE4500DL)

Note: 1D and 2D scan engines don't coexist on the mobile computer as they are both barcode readers and the mobile computer allows one barcode reader only.

IN THIS CHAPTER

Symbologies Supported..... 133

SYMBOLOGIES SUPPORTED

Depending on the scan engine integrated on the mobile computer, supported symbologies will differ as listed below. For details on configuring associated settings, refer to Appendix II, III, and IV.

		CCD	Laser	2D
Codabar		✓	✓	✓
Code 11		✗	✓	✓
Code 39	Code 39	✓	✓	✓
	Trioptic Code 39	✗	✓	✓
	Italian Pharmacode (Code 32)	✓	✓	✓
Code 93		✓	✓	✓
Code 128	Code 128	✓	✓	✓
	GS1-128 (EAN-128)	✓	✓	✓
	ISBT 128	✓	✓	✓
Code 2 of 5	Chinese 25	✗	✓	✓
	Industrial 25 (Discrete 25)	✓	✓	✓
	Interleaved 25	✓	✓	✓
	Convert Interleaved 25 to EAN-13	✗	✓	✓
	Matrix 25	✗	✗	✓
Composite Code	Composite CC-A/B	✗	✗	✓
	Composite CC-C	✗	✗	✓
	Compostie TLC 39	✗	✗	✓
GS1 DataBar (RSS)	GS1 DataBar-14 (RSS-14)	✓	✓	✓
	GS1 DataBar Limited (RSS Limited)	✓	✓	✓
	GS1 DataBar Expanded (RSS Expanded)	✓	✓	✓
	Convert to UPC/EAN	✗	✓	✓
MSI		✓	✓	✓
Postal Codes	Australian Postal	✗	✗	✓
	Japan Postal	✗	✗	✓

	Netherlands KIX Code	✘	✘	✓
	US Postnet	✘	✘	✓
	US Planet	✘	✘	✓
	UK Postal	✘	✘	✓
EAN/UPC	EAN-8	✓	✓	✓
	EAN-8 Extend	✓	✓	✓
	EAN-13	✓	✓	✓
	Bookland EAN (ISBN)	✓	✓	✓
	ISSN EAN	✘	✘	✓
	UPC-A	✓	✓	✓
	UPC-E	✓	✓	✓
	Convert to UPC-A	✓	✓	✓
	UPC-E1	✓	✓	✓
	Convert to UPC-A	✓	✓	✓
2D Symbologies	Aztec	✘	✘	✓
	Data Matrix	✘	✘	✓
	Maxicode	✘	✘	✓
	MacroPDF	✘	✘	✓
	MicroPDF417	✘	✘	✓
	MicroQR	✘	✘	✓
	PDF417	✘	✘	✓
	QR Code	✘	✘	✓

CCD (SM1)

The tables below list the symbologies settings for CCD scan engine (SM1).

SYMBOLGY SETTINGS

CCD Engine	Description	Default
CODABAR		
Codabar		Enable
Codabar	Switch to enable Codabar decoding.	Enable
Length option	Sets the length of the Codabar symbols to decode. <ul style="list-style-type: none"> ▶ One Fixed length (Length 1) ▶ Two Fixed lengths (Length 1 > Length 2) ▶ Max / Min Length (range: 0-55; Length 1 < Length 2) ▶ Any Length 	Max / Min Length (4-55)
CLSI Editing	When applied, the CLSI editing strips the start/stop characters and inserts a space after the first, fifth, and tenth characters of a 14-character Codabar barcode. <ul style="list-style-type: none"> ▶ The 14-character barcode length does not include start/stop characters. 	Disable
NOTIS Editing	Sets whether to include start/stop characters in the transmitted data. <ul style="list-style-type: none"> ▶ NOTIS Editing is to strip the start/stop characters, i.e. to disable "Transmit Start/Stop Characters". 	Disable
CODE 39		
Code 39		Enable
Code 39	Switch to enable Code 39 decoding.	Enable
Convert to Code 32	Selects whether to convert decoded data to Italian Pharmacode.	Disable
Code 32 Prefix	Prefix character "A" to Code 32 barcodes. <ul style="list-style-type: none"> ▶ "Convert to Code 32" must be enabled for this to function properly. 	Disable
Verify Check Digit	Selects whether to verify the Modulo 43 check digit. If the check digit is incorrect, the barcode will not be accepted.	Disable
Transmit Check Digit	Decide whether to include the check digit in the data to transmit. <ul style="list-style-type: none"> ▶ "Verify Check Digit" must be enabled. 	Disable

Support Full ASCII	Selects whether to enable Code 39 Full ASCII decoding. Characters are paired to encode the full ASCII character set.	Disable
Length option	<p>Sets the length of the Code 39 symbols to decode.</p> <ul style="list-style-type: none"> ▶ One Fixed length (Length 1) ▶ Two Fixed lengths (Length 1>Length 2) ▶ Max / Min Length (range: 0-55; Length 1<Length 2) ▶ Any Length 	Max / Min Length (4-55)
CODE 93		
Code 93		Enable
Code 93	Switch to enable Code 93 decoding.	Enable
Length option	<p>Sets the length of the Code 93 symbols to decode.</p> <ul style="list-style-type: none"> ▶ One Fixed length (Length 1) ▶ Two Fixed lengths (Length 1>Length 2) ▶ Max / Min Length (range: 0-55; Length 1<Length 2) ▶ Any Length 	Max / Min Length (4-55)
CODE 128		
Code 128		
Code 128	Switch to enable Code 128 decoding.	Enable
GS1-128		
GS1-128	Switch to enable GS1-128 decoding.	Enable
ISBT 128		
ISBT 128	Switch to enable ISBT 128 decoding.	Enable
CODE 2 OF 5		
Discrete 25		
Discrete 25	Switch to enable Discrete 2 of 5 decoding.	Enable
Length option	<p>Sets the length of the Discrete 25 symbols to decode.</p> <ul style="list-style-type: none"> ▶ One Fixed length (Length 1) ▶ Two Fixed lengths (Length 1>Length 2) ▶ Max / Min Length (range: 0-55; Length 1<Length 2) ▶ Any Length 	Max / Min Length (4-55)

Interleaved 25		
Interleaved 25	Switch to enable Interleaved 2 of 5 decoding.	Enable
Length option	Sets the length of the Interleaved 2 of 5 symbols to decode. <ul style="list-style-type: none"> ▶ One Fixed length (Length 1) ▶ Two Fixed lengths (Length 1 > Length 2) ▶ Max / Min Length (range: 0-55; Length 1 < Length 2) ▶ Any Length 	Max / Min Length (4-55)
Verify Check Digit	Decide whether to verify the check digit. If desired, select one of the algorithms below. If the check digit is incorrect, the barcode will not be accepted. <ul style="list-style-type: none"> ▶ Disable ▶ USS Check Digit ▶ OPCC Check Digit 	Disable
Transmit Check Digit	Decide whether to include the check digit in the data being transmitted.	Disable
GS1 DATABAR		
GS1 DataBar-14		
GS1 DataBar-14	Switch to enable GS1 DataBar-14 decoding.	Enable
GS1 DataBar Limited		
GS1 DataBar Limited	Switch to enable GS1 DataBar Limited decoding.	Enable
GS1 DataBar Expanded		
GS1 DataBar Expanded	Switch to enable GS1 DataBar Expanded decoding.	Enable
MSI		
MSI		
MSI	Switch to enable MSI decoding.	Enable
Length option	Sets the length of the MSI symbols to decode. <ul style="list-style-type: none"> ▶ One Fixed length (Length 1) ▶ Two Fixed lengths (Length 1 > Length 2) ▶ Max / Min Length (range: 0-55; Length 1 < Length 2) ▶ Any Length 	Max / Min Length (4-55)
Verify Check Digit	One check digit is mandatory for decoding MSI barcodes. Select whether a second check digit should be verified. If the check digits are incorrect, the barcode will not be accepted. <ul style="list-style-type: none"> ▶ One Check Digit ▶ Two Check Digits 	One Check Digit
Transmit Check Digit	Decide whether to include the check digit in the data being transmitted.	Disable

Algorithm	When two check digits are set for verification, two choices are available for the pair of check digits. <ul style="list-style-type: none"> ▶ Modulo10 / Modulo11 ▶ Double Modulo 10 	Double Modulo 10
UPC/EAN		
EAN-8		
EAN-8	Switch to enable EAN-8 decoding.	Enable
Addon 2	Decide whether to decode EAN-8 with addon 2. <ul style="list-style-type: none"> ▶ Ignore Addon ▶ Auto-discriminate 	Ignore addon
Addon 5	Decide whether to decode EAN-8 with addon 5. <ul style="list-style-type: none"> ▶ Ignore Addon ▶ Auto-discriminate 	Ignore addon
Convert to EAN-13	Checkbox to enable converting EAN-8 to EAN-13 format.	Disable
EAN-13		
EAN-13	Switch to enable EAN-13 decoding.	Enable
Bookland EAN	Checkbox to enable ISBN decoding. If enabled, select Bookland ISBN Format in the drop-down box below.	Enable
Bookland ISBN Format	Select to decode Bookland data starting with 978 as 10-digit format along with the Bookland check digit, or decode Bookland data starting with 978/979 as EAN-13 format.	Bookland ISBN-10
Addon 2	Decide whether to decode EAN-13 with addon 2. <ul style="list-style-type: none"> ▶ Ignore Addon ▶ Auto-discriminate 	Ignore addon
Addon 5	Decide whether to decode EAN-13 with addon 5. <ul style="list-style-type: none"> ▶ Ignore Addon ▶ Auto-discriminate 	Ignore addon
Transmit Check Digit	Decide whether to include the EAN-13 check digit (the last character in the barcode) in the data being transmitted.	Enable
UPC-A		
UPC-A	Switch to enable UPC-A decoding.	Enable
Addon 2	Decide whether to decode UPC-A with addon 2. <ul style="list-style-type: none"> ▶ Ignore Addon ▶ Auto-discriminate 	Ignore addon
Addon 5	Decide whether to decode UPC-A with addon 5. <ul style="list-style-type: none"> ▶ Ignore Addon ▶ Auto-discriminate 	Ignore addon

Preamble	Decide whether to include the UPC-A/UPC-E/UPC-E1 preamble System Character (and Country Code) in the data being transmitted. <ul style="list-style-type: none"> ▶ No transmit: transmits none of the above ▶ Transmit System Character: transmits system number only ▶ Transmit Sys. Character and Country Code: transmits system number and country code 	Transmit System Character
Transmit Check Digit	Decide whether to include the UPC-A check digit (the last character in the barcode) in the data being transmitted.	Enable
UPC-E		
UPC-E	Switch to enable UPC-E decoding.	Enable
Addon 2	Decide whether to decode UPC-E with addon 2. <ul style="list-style-type: none"> ▶ Ignore Addon ▶ Auto-discriminate 	Ignore addon
Addon 5	Decide whether to decode UPC-E with addon 5. <ul style="list-style-type: none"> ▶ Ignore Addon ▶ Auto-discriminate 	Ignore addon
Preamble	Decide whether to include the UPC-A/UPC-E/UPC-E1 preamble System Character (and Country Code) in the data being transmitted. <ul style="list-style-type: none"> ▶ No transmit: transmits none of the above ▶ Transmit System Character: transmits system number only ▶ Transmit Sys. Character and Country Code: transmits system number and country code 	Transmit System Character
Convert to UPC-A	The UPC-E barcode will be expanded into UPC-A format, and the next process will follow the settings configured for UPC-A.	Disable
Transmit Check Digit	Decide whether to include the UPC-E1 check digit (the last character in the barcode) in the data being transmitted.	Enable
UPC-E1		
UPC-E1	Switch to enable UPC-E1 decoding.	Disable
Addon 2	Decide whether to decode UPC-E1 with addon 2. <ul style="list-style-type: none"> ▶ Ignore Addon ▶ Auto-discriminate 	Ignore addon
Addon 5	Decide whether to decode UPC-E1 with addon 5. <ul style="list-style-type: none"> ▶ Ignore Addon ▶ Auto-discriminate 	Ignore addon

Preamble	<p>Decide whether to include the UPC-A/UPC-E/UPC-E1 preamble System Character (and Country Code) in the data being transmitted.</p> <ul style="list-style-type: none"> ▶ No transmit: transmits none of the above ▶ Transmit System Character: transmits system number only ▶ Transmit Sys. Character and Country Code: transmits system number and country code 	Transmit System Character
Convert to UPC-A	The UPC-E1 barcode will be expanded into UPC-A format, and the next process will follow the settings configured for UPC-A.	Disable
Transmit Check Digit	Decide whether to include the UPC-E1 check digit (the last character in the barcode) in the data being transmitted.	Enable

LASER (SE955)

The tables below list the symbologies settings for 1D laser scan engine (SE955).

SYMBOLGY SETTINGS

Symbology	Description	Default
CODABAR		
CodaBar		Enable
Codabar	Switch to enable Codabar decoding.	Enable
Length option	Sets the length of the Codabar symbols to decode. <ul style="list-style-type: none"> ▶ One Fixed length (Length 1) ▶ Two Fixed lengths (Length 1>Length 2) ▶ Max / Min Length (range: 0-55; Length 1<Length 2) ▶ Any Length 	Max / Min Length (4-55)
CLSI Editing	When applied, the CLSI editing strips the start/stop characters and inserts a space after the first, fifth, and tenth characters of a 14-character Codabar barcode. <ul style="list-style-type: none"> ▶ The 14-character barcode length does not include start/stop characters. 	Disable
NOTIS Editing	Sets whether to include start/stop characters in the transmitted data. <ul style="list-style-type: none"> ▶ NOTIS Editing is to strip the start/stop characters, i.e. to disable "Transmit Start/Stop Characters". 	Disable
CODE 11		
Code 11		Enable
Code 11	Switch to enable Code 11 decoding.	Enable
Check Digit Option	Sets whether to verify check digits according to the selected option. If the check digits are incorrect, the barcode will not be accepted. <ul style="list-style-type: none"> ▶ Disable ▶ One Check Digit ▶ Two Check Digits 	Disable
Transmit Check Digit	Selects whether to include check digits in the transmitted data. <ul style="list-style-type: none"> ▶ Check Digit Option" must be enabled. 	Disable

Length option	Sets the length of the Code 11 symbols to decode. <ul style="list-style-type: none"> ▶ One Fixed length (Length 1) ▶ Two Fixed lengths (Length 1>Length 2) ▶ Max / Min Length (range: 0-55; Length 1<Length 2) ▶ Any Length 	Max / Min Length (4-55)
CODE 39		
Code 39		Enable
Code 39	Switch to enable Code 39 decoding.	Enable
Trioptic Code 39	Selects whether to decode Trioptic Code 39. <ul style="list-style-type: none"> ▶ Trioptic Code 39 is a variant of Code 39 used in the marking of computer tape cartridges. It always contains six characters. 	Enable
Convert to Code 32	Selects whether to convert decoded data to Italian Pharmacode.	Enable
Code 32 Prefix	Prefix character "A" to Code 32 barcodes. <ul style="list-style-type: none"> ▶ "Convert to Code 32" must be enabled for this to function properly. 	Disable
Verify Check Digit	Selects whether to verify the Modulo 43 check digit. If the check digit is incorrect, the barcode will not be accepted.	Disable
Transmit Check Digit	Decide whether to include the check digit in the data to transmit. <ul style="list-style-type: none"> ▶ "Verify Check Digit" must be enabled. 	Disable
Support Full ASCII	Selects whether to enable Code 39 Full ASCII decoding. Characters are paired to encode the full ASCII character set.	Disable
Length option	Sets the length of the Code 39 symbols to decode. <ul style="list-style-type: none"> ▶ One Fixed length (Length 1) ▶ Two Fixed lengths (Length 1>Length 2) ▶ Max / Min Length (range: 0-55; Length 1<Length 2) ▶ Any Length 	Max / Min Length (4-55)
CODE 93		
Code 93		Enable
Code 93	Switch to enable Code 93 decoding.	Enable

Length option	Sets the length of the Code 93 symbols to decode. <ul style="list-style-type: none"> ▶ One Fixed length (Length 1) ▶ Two Fixed lengths (Length 1>Length 2) ▶ Max / Min Length (range: 0-55; Length 1<Length 2) ▶ Any Length 	Max / Min Length (4-55)
CODE 128		
Code 128		Enable
Code 128	Switch to enable Code 128 decoding.	Enable
GS1-128		Enable
GS1-128	Switch to enable GS1-128 decoding.	Enable
ISBT 128		Enable
ISBT 128	Switch to enable ISBT 128 decoding.	Enable
CODE 2 OF 5		
Chinese 25		Enable
Chinese 25	Switch to enable Chinese 2 of 5 decoding.	Enable
Discrete 25		Enable
Discrete 25	Switch to enable Discrete 25 decoding.	Enable
Length option	Sets the length of the Discrete 2 of 5 symbols to decode. <ul style="list-style-type: none"> ▶ One Fixed length (Length 1) ▶ Two Fixed lengths (Length 1>Length 2) ▶ Max / Min Length (range: 0-55; Length 1<Length 2) ▶ Any Length 	Max / Min Length (4-55)
Interleaved 25		Enable
Interleaved 25	Switch to enable Interleaved 2 of 5 decoding.	Enable
Length option	Sets the length of the Interleaved 2 of 5 symbols to decode. <ul style="list-style-type: none"> ▶ One Fixed length (Length 1) ▶ Two Fixed lengths (Length 1>Length 2) ▶ Max / Min Length (range: 0-55; Length 1<Length 2) ▶ Any Length 	Max / Min Length (4-55)
Verify Check Digit	Decide whether to verify the check digit. If desired, select one of the algorithms below. If the check digit is incorrect, the barcode will not be accepted. <ul style="list-style-type: none"> ▶ Disable ▶ USS Check Digit ▶ OPCC Check Digit 	Disable

Transmit Check Digit	Decide whether to include the check digit in the data being transmitted.	Disable
Convert To EAN-13	Convert a 14-character Interleaved 25 barcode into EAN-13 if the following requirements are met: The barcode must have a leading 0 and a valid EAN-13 check digit.	Disable
GS1 DATABAR		
GS1 DataBar-14		Enable
GS1 DataBar-14	Switch to enable GS1 DataBar-14 decoding.	Enable
Convert to UPC/EAN	Strips the leading '010' of GS1 DataBar and converts the barcode to EAN-13.	Disable
GS1 DataBar Limited		Enable
GS1 DataBar Limited	Switch to enable GS1 DataBar Limited decoding.	Enable
GS1 DataBar Expanded		Enable
GS1 DataBar Expanded	Switch to enable GS1 DataBar Expanded decoding.	Enable
MSI		
MSI		Enable
MSI	Switch to enable MSI decoding.	Enable
Length option	Sets the length of the MSI symbols to decode. <ul style="list-style-type: none"> ▶ One Fixed length (Length 1) ▶ Two Fixed lengths (Length 1 > Length 2) ▶ Max / Min Length (range: 0-55; Length 1 < Length 2) ▶ Any Length 	Max / Min Length (4-55)
Verify Check Digit	One check digit is mandatory for decoding MSI barcodes. Select whether a second check digit should be verified. If the check digits are incorrect, the barcode will not be accepted. <ul style="list-style-type: none"> ▶ One Check Digit ▶ Two Check Digits 	One Check Digit
Transmit Check Digit	Decide whether to include the check digit in the data being transmitted.	Disable
Algorithm	When two check digits are set for verification, two choices are available for the pair of check digits. <ul style="list-style-type: none"> ▶ Modulo10 / Modulo11 ▶ Double Modulo 10 	Double Modulo 10
UPC/EAN		
EAN-8		Enable
EAN-8	Switch to enable EAN-8 decoding.	Enable
Convert to EAN-13	Checkbox to enable converting EAN-8 to EAN-13 format.	Disable

EAN-13		Enable
EAN-13	Switch to enable EAN-13 decoding.	Enable
Bookland EAN	Checkbox to enable ISBN decoding. If enabled, select Bookland ISBN Format in the drop-down box below.	Enable
Bookland ISBN Format	Select to decode Bookland data starting with 978 as 10-digit format along with the Bookland check digit, or decode Bookland data starting with 978/979 as EAN-13 format.	Bookland ISBN-10
Transmit Check Digit	Decide whether to include the EAN-13 check digit (the last character in the barcode) in the data being transmitted.	Enable
UPC-A		Enable
UPC-A	Switch to enable UPC-A decoding.	Enable
Addon 2	Decide whether to decode UPC-A with addon 2. <ul style="list-style-type: none"> ▶ Ignore Addon ▶ Auto-discriminate 	Ignore addon
Addon 5	Decide whether to decode UPC-A with addon 5. <ul style="list-style-type: none"> ▶ Ignore Addon ▶ Auto-discriminate 	Ignore addon
Preamble	Decide whether to include the UPC-A/UPC-E/UPC-E1 preamble System Character (and Country Code) in the data being transmitted. <ul style="list-style-type: none"> ▶ No transmit: transmits none of the above ▶ Transmit System Character: transmits system number only ▶ Transmit Sys. Character and Country Code: transmits system number and country code 	Transmit System Character
Transmit Check Digit	Decide whether to include the UPC-A check digit (the last character in the barcode) in the data being transmitted.	Enable
UPC-E		Enable
UPC-E	Switch to enable UPC-E decoding.	Enable
Addon 2	Decide whether to decode UPC-E with addon 2. <ul style="list-style-type: none"> ▶ Ignore Addon ▶ Auto-discriminate 	Ignore addon
Addon 5	Decide whether to decode UPC-E with addon 5. <ul style="list-style-type: none"> ▶ Ignore Addon ▶ Auto-discriminate 	Ignore addon

Preamble	Decide whether to include the UPC-A/UPC-E/UPC-E1 preamble System Character (and Country Code) in the data being transmitted. <ul style="list-style-type: none"> ▶ No transmit: transmits none of the above ▶ Transmit System Character: transmits system number only ▶ Transmit Sys. Character and Country Code: transmits system number and country code 	Transmit System Character
Convert to UPC-A	The UPC-E barcode will be expanded into UPC-A format, and the next process will follow the settings configured for UPC-A.	Disable
Transmit Check Digit	Decide whether to include the UPC-E1 check digit (the last character in the barcode) in the data being transmitted.	Enable
UPC-E1		Disable
UPC-E1	Switch to enable UPC-E1 decoding.	Disable
Addon 2	Decide whether to decode UPC-E1 with addon 2. <ul style="list-style-type: none"> ▶ Ignore Addon ▶ Auto-discriminate 	Ignore addon
Addon 5	Decide whether to decode UPC-E1 with addon 5. <ul style="list-style-type: none"> ▶ Ignore Addon ▶ Auto-discriminate 	Ignore addon
Preamble	Decide whether to include the UPC-A/UPC-E/UPC-E1 preamble System Character (and Country Code) in the data being transmitted. <ul style="list-style-type: none"> ▶ No transmit: transmits none of the above ▶ Transmit System Character: transmits system number only ▶ Transmit Sys. Character and Country Code: transmits system number and country code 	Transmit System Character
Convert to UPC-A	The UPC-E1 barcode will be expanded into UPC-A format, and the next process will follow the settings configured for UPC-A.	Disable
Transmit Check Digit	Decide whether to include the UPC-E1 check digit (the last character in the barcode) in the data being transmitted.	Enable
Coupon Code		
Coupon Code	Switch to enable Coupon Code decoding.	Disable

MISCELLANEOUS

Laser Engine	Description	Default
Miscellaneous Options		

Transmit AIM Code ID	Decide whether to include AIM Code ID in the data. Each AIM Code ID contains a three-character string "]cm ": <ul style="list-style-type: none"> ▶] = Flag Character (ASCII 93) ▶ c = Code Character (see below) ▶ m = Modifier Character (see below) 	Disable
----------------------	---	---------

AIM CODE ID – CODE CHARACTERS

Code Character	Code Type
A	Code 39, Code 39 Full ASCII, Code 32
C	Code 128, Coupon (Code 128 portion)
d	Data Matrix
E	UPC/EAN, Coupon (UPC portion)
e	GS1 DataBar (RSS)
F	Codabar
G	Code 93
H	Code 11
I	Interleaved 25
L	PDF417, Macro PDF417, Micro PDF417
M	MSI
Q	QR Code, MicroQR
S	Industrial 25 (Discrete 25), IATA 2 of 5
U	Maxicode
X	Code 39 Trioptic, Bookland EAN, Matrix 25, US Postnet, US Planet, UK Postal, Japan Postal, Australian Postal, Dutch Postal
z	Aztec

AIM CODE ID – MODIFIER CHARACTERS

Code Type	Option Value	Option
Code 39	0	No check character or Full ASCII processing.
	1	Check digit has been verified.
	3	Check digit has been verified and stripped.
	4	Full ASCII conversion has been performed.
	5	Result of option values 4 and 1.
	7	Result of option values 4 and 3.

Code 128	0	Standard data packet. No Function Code 1 "FNC1" in the first character position.
	1	Function Code 1 "FNC1" in the first character position.
	2	Function Code 1 "FNC1" in the second character position.
Interleaved 25	0	No check digit processing.
	1	Check digit has been verified.
	3	Check digit has been verified and stripped.
Codabar	0	No check digit processing.
Code 93	0	Always transmit 0.
MSI	0	Modulo 10 check digit verified and transmitted.
	1	Modulo 10 check digit verified but not transmitted.
Industrial 25 (Discrete 25)	0	Always transmit 0.
UPC/EAN	0	Standard data packet in full EAN country code format, which is 13 digits for UPC-A and UPC-E (not including addons).
	3	Standard data packet with two-digit or five-digit addons.
	4	EAN-8 data packet.
	A UPC-A with Addon 2 barcode, 012345678905-10, is transmitted to the host as a 18-character string, 1E3001234567890510 .	
Bookland EAN	0	Always transmit 0.
Trioptic Code 39	0	Always transmit 0.
Code 11	0	Single check digit (has been verified.)
	1	Two check digits (has been verified.)
	3	Check digit has been verified but not transmitted.
GS1 DataBar (RSS)	0	Always transmit 0.
	RSS-14 and RSS Limited will be transmitted with an Application Identifier "01". For example, an RSS-14 barcode, 10012345678902, is transmitted as 1e00110012345678902 .	

Note: In EAN-128 emulation mode, RSS is transmitted using Code 128 rules (= "]C1").

EAN.UCC Composites (RSS, EAN-128, 2D portion of UPC composite)	Native mode transmission	
	0	Standard data packet
	1	Data packet containing the data following an encoded symbol separator character.
	2	Data packet containing the data following an escape mechanism character. The data packet does not support the ECI protocol.

	3	Data packet containing the data following an escape mechanism character. The data packet supports the ECI protocol.
	EAN-128 emulation	
	1	Data packet is a EAN-128 barcode (= data is preceded with "JJC1").

Note: UPC portion of composite is transmitted using UPC rules.

PDF417, Micro PDF417	0	Scan engine is set to conform to protocol defined in 1994 PDF417 symbology specifications. ▶ When this option is transmitted, the receiver cannot reliably determine whether ECIs have been invoked or whether data byte 92 _{DEC} has been doubled in transmission.
	1	Scan engine is set to follow the ECI protocol (Extended Channel Interpretation). All data characters 92 _{DEC} are doubled.
	2	Scan engine is set for Basic Channel operation (no escape character transmission protocol). Data characters 92 _{DEC} are not doubled. ▶ When decoders are set to this mode, unbuffered Macro symbols and symbols requiring the decoder to convey ECI escape sequences cannot be transmitted.
	3	The barcode contains a EAN-128 symbol, and the first codeword is 903-907, 912, 914, 915.
	4	The barcode contains a EAN-128 symbol, and the first codeword is in the range 908-909.
	5	The barcode contains a EAN-128 symbol, and the first codeword is in the range 910-911.
	A PDF417 barcode, ABCD, with no transmission protocol enabled, is transmitted as]L2ABCD.	

Data Matrix	0	ECC 000-140, not supported.
	1	ECC 200.
	2	ECC 200, FNC1 in first or fifth position.
	3	ECC 200, FNC1 in second or sixth position.
	4	ECC 200, ECI protocol implemented.
	5	ECC 200, FNC1 in first or fifth position, ECI protocol implemented.
	6	ECC 200, FNC1 in second or sixth position, ECI protocol implemented.
Maxicode	0	Mode 4 or 5
	1	Mode 2 or 3
	2	Mode 4 or 5, ECI protocol implemented.
	3	Mode 2 or 3, ECI protocol implemented in secondary message.
QR Code	0	Model 1
	1	Model 2 / MicroQR ECI protocol not implemented.
	2	Model 2, ECI protocol implemented.
	3	Model 2, ECI protocol not implemented, FNC1 implied in first position.
	4	Model 2, ECI protocol implemented, FNC1 implied in first position.
	5	Model 2, ECI protocol not implemented, FNC1 implied in second position.
	6	Model 2, ECI protocol implemented, FNC1 implied in second position
Aztec	0	Aztec symbol.
	C	Aztec Rune symbol.

Note: For JPEG files, these BPP settings are ignored for it always uses 8 bits per pixel!

2D IMAGER (SE4500DL)

The tables below list the symbology settings for 2D imager (SE4500DL).

SYMBOLGY SETTINGS

1D SYMBOLOGIES

Symbology	Description	Default
CODABAR		
CodaBar		Enable
Codabar	Switch to enable Codabar decoding.	Enable
Length option	Sets the length of the Codabar symbols to decode. <ul style="list-style-type: none"> ▶ One Fixed length (Length 1) ▶ Two Fixed lengths (Length 1 > Length 2) ▶ Max / Min Length (range: 0-55; Length 1 < Length 2) ▶ Any Length 	Max / Min Length (4-55)
CLSI Editing	When applied, the CLSI editing strips the start/stop characters and inserts a space after the first, fifth, and tenth characters of a 14-character Codabar barcode. <ul style="list-style-type: none"> ▶ The 14-character barcode length does not include start/stop characters. 	Disable
NOTIS Editing	Sets whether to include start/stop characters in the transmitted data. <ul style="list-style-type: none"> ▶ NOTIS Editing is to strip the start/stop characters, i.e. to disable "Transmit Start/Stop Characters". 	Disable
CODE 11		
Code 11		Enable
Code 11	Switch to enable Code 11 decoding.	Enable
Check Digit Option	Sets whether to verify check digits according to the selected option. If the check digits are incorrect, the barcode will not be accepted. <ul style="list-style-type: none"> ▶ Disable ▶ One Check Digit ▶ Two Check Digits 	Disable
Transmit Check Digit	Selects whether to include check digits in the transmitted data. <ul style="list-style-type: none"> ▶ Check Digit Option" must be enabled. 	Disable

Length option	Sets the length of the Code 11 symbols to decode. <ul style="list-style-type: none"> ▶ One Fixed length (Length 1) ▶ Two Fixed lengths (Length 1>Length 2) ▶ Max / Min Length (range: 0-55; Length 1<Length 2) ▶ Any Length 	Max / Min Length (4-55)
CODE 39		
Code 39		Enable
Code 39	Switch to enable Code 39 decoding.	Enable
Trioptic Code 39	Selects whether to decode Trioptic Code 39. <ul style="list-style-type: none"> ▶ Trioptic Code 39 is a variant of Code 39 used in the marking of computer tape cartridges. It always contains six characters. 	Enable
Convert to Code 32	Selects whether to convert decoded data to Italian Pharmacode.	Enable
Code 32 Prefix	Prefix character "A" to Code 32 barcodes. <ul style="list-style-type: none"> ▶ "Convert to Code 32" must be enabled for this to function properly. 	Disable
Verify Check Digit	Selects whether to verify the Modulo 43 check digit. If the check digit is incorrect, the barcode will not be accepted.	Disable
Transmit Check Digit	Decide whether to include the check digit in the data to transmit. <ul style="list-style-type: none"> ▶ "Verify Check Digit" must be enabled. 	Disable
Support Full ASCII	Selects whether to enable Code 39 Full ASCII decoding. Characters are paired to encode the full ASCII character set.	Disable
Length option	Sets the length of the Code 39 symbols to decode. <ul style="list-style-type: none"> ▶ One Fixed length (Length 1) ▶ Two Fixed lengths (Length 1>Length 2) ▶ Max / Min Length (range: 0-55; Length 1<Length 2) ▶ Any Length 	Max / Min Length (4-55)
CODE 93		
Code 93		Enable
Code 93	Switch to enable Code 93 decoding.	Enable
Length option	Sets the length of the Code 93 symbols to decode. <ul style="list-style-type: none"> ▶ One Fixed length (Length 1) ▶ Two Fixed lengths (Length 1>Length 2) ▶ Max / Min Length (range: 0-55; Length 1<Length 2) ▶ Any Length 	Max / Min Length (4-55)
CODE 128		
Code 128		Enable

Code 128	Switch to enable Code 128 decoding.	Enable
GS1-128		Enable
GS1-128	Switch to enable GS1-128 decoding.	Enable
Separator Character	Enable the function code character separator, which is used to separate data fields of variable length and application identifiers of subsequent data fields in concatenated data strings. Tap the keyboard icon to open a mapping table for selecting a separator character to replace with.	None
ISBT-128		Enable
ISBT 128	Switch to enable ISBT 128 decoding.	Enable
Concatenation	Sets whether to enable decoding ISBT-128 by performing concatenation of ISBT data <ul style="list-style-type: none"> ▶ Disable: Does not perform concatenation ▶ Enable: Performs concatenation on all ISBT-128 barcodes. ▶ Auto-discriminate: Auto-discriminates between the ISBT-128 barcodes which require concatenation and those which do not need concatenation. 	Auto-discriminate
Redundancy	When "Auto-discriminate" is applied, decide the number of times of supplementary decoding the same barcode to count as a valid read. Configurable between 2 and 20	10
CODE 2 OF 5		
Chinese 25		Enable
Chinese 25	Switch to enable Chinese 2 of 5 decoding.	Enable
Discrete 25		Enable
Discrete 25	Switch to enable Discrete 2 of 5 decoding.	Enable

Length option	Sets the length of the Discrete 2 of 5 symbols to decode. <ul style="list-style-type: none"> ▶ One Fixed length (Length 1) ▶ Two Fixed lengths (Length 1 > Length 2) ▶ Max / Min Length (range: 0-55; Length 1 < Length 2) ▶ Any Length 	Max / Min Length (4-55)
Interleaved 25		Enable
Interleaved 25	Switch to enable Interleaved 2 of 5 decoding.	Enable
Length option	Sets the length of the Interleaved 2 of 5 symbols to decode. <ul style="list-style-type: none"> ▶ One Fixed length (Length 1) ▶ Two Fixed lengths (Length 1 > Length 2) ▶ Max / Min Length (range: 0-55; Length 1 < Length 2) ▶ Any Length 	Max / Min Length (4-55)
Verify Check Digit	Decide whether to verify the check digit. If desired, select one of the algorithms below. If the check digit is incorrect, the barcode will not be accepted. <ul style="list-style-type: none"> ▶ Disable ▶ USS Check Digit ▶ OPCC Check Digit 	Disable
Transmit Check Digit	Decide whether to include the check digit in the data being transmitted.	Disable
Convert To EAN-13	Convert a 14-character Interleaved 25 barcode into EAN-13 if the following requirements are met: <ul style="list-style-type: none"> ▶ The barcode must have a leading 0 and a valid EAN-13 check digit. 	Disable
Matrix 25		Enable
Matrix 25	Switch to enable Matrix 2 of 5 decoding.	Enable
Length option	Sets the length of the Matrix 2 of 5 symbols to decode. <ul style="list-style-type: none"> ▶ One Fixed length (Length 1) ▶ Two Fixed lengths (Length 1 > Length 2) ▶ Max / Min Length (range: 0-55; Length 1 < Length 2) ▶ Any Length 	Max / Min Length (4-55)
Redundancy	Enables or disable read redundancy for Matrix 2 of 5.	Disable
Verify Check Digit	Select whether to verify the check digit, which is the last character of the barcode. If the check digit is incorrect, the barcode will not be accepted.	Disable
Transmit Check Digit	Decide whether to include the check digit in the data being transmitted.	Disable
COMPOSITE		
Composite CC-A/B		Disable

Composite CC-A/B	Switch to enable Composite CC-A/B decoding.	Disable
Composite CC-C		Enable
Composite CC-C	Switch to enable Composite CC-C decoding.	Enable
Composite TLC 39		Disable
Composite TLC 39	Switch to enable Composite TLC 39 decoding.	Disable
Composite General Preference		
UPC Composite Mode	<p>UPC barcodes can be "linked" with a 2D barcode during transmission as if they were one barcode.</p> <hr/> <p>UPC Never Linked</p> <p>Transmit UPC barcodes regardless of whether a 2D barcode is detected.</p> <hr/> <p>UPC Always Linked</p> <p>Transmit UPC barcodes and the 2D portion. If the 2D portion is not detected, the UPC barcode will not be transmitted.</p> <p>▶ CC-A/B or CC-C must be enabled.</p> <hr/> <p>Auto-discriminate</p> <p>Transmit UPC barcodes as well as the 2D portion if present.</p>	UPC always Linked
GS1-128 Emulation Mode	Sets GS1-128 emulation mode for UCC/EAN Composite Codes.	Disable
GS1 DATABAR		
GS1 DataBar-14		Enable
GS1 DataBar-14	Switch to enable GS1 DataBar-14 decoding.	Enable
Convert to UPC/EAN	Strips the leading '010' of GS1 DataBar and converts the barcode to EAN-13.	Disable
GS1 DataBar Limited		Enable
GS1 DataBar Limited	Switch to enable GS1 DataBar Limited decoding.	Enable
Convert to UPC/EAN	Strips the leading '010' of GS1 DataBar Limited and converts the barcode to EAN-13.	Disable
GS1 DataBar Expanded		Enable
GS1 DataBar Expanded	Switch to enable GS1 DataBar Expanded decoding.	Enable
Separator Character	Enable the function code character separator, which is used to separate data fields of variable length and application identifiers of subsequent data fields in concatenated data strings.	None
KOREAN 3 OF 5		

Korean 3 of 5		Disable
MSI		
MSI		Enable
MSI	Switch to enable MSI decoding.	Enable
Length option	<p>Sets the length of the MSI symbols to decode.</p> <ul style="list-style-type: none"> ▶ One Fixed length (Length 1) ▶ Two Fixed lengths (Length 1 > Length 2) ▶ Max / Min Length (range: 0-55; Length 1 < Length 2) ▶ Any Length 	Max / Min Length (4-55)
Verify Check Digit	<p>One check digit is mandatory for decoding MSI barcodes. Select whether a second check digit should be verified. If the check digits are incorrect, the barcode will not be accepted.</p> <ul style="list-style-type: none"> ▶ One Check Digit ▶ Two Check Digits 	One Check Digit
Transmit Check Digit	Decide whether to include the check digit in the data being transmitted.	Disable
Algorithm	<p>When two check digits are set for verification, two choices are available for the pair of check digits.</p> <ul style="list-style-type: none"> ▶ Modulo10 / Modulo11 ▶ Double Modulo 10 	Double Modulo 10
POSTAL CODE		
Australian Postal		Enable
Japan Postal		Enable
Netherlands KIX Code		Enable
US Postnet		Enable
US Planet		Enable
USPS Postal		Enable
UPU FICS Postal		Enable
UK Postal		Enable
Postal General Preference		Enable
US Postal Check Digit	Decide whether to transmit check digit for US Postnet or US Planet.	Enable
UK Postal Check Digit	Decide whether to transmit check digit for UK Postal.	Enable
UPC/EAN		
EAN-8		Enable
EAN-8	Switch to enable EAN-8 decoding.	Enable

Addon 2	Decide whether to decode EAN-8 with addon 2. <ul style="list-style-type: none"> ▶ Ignore Addon ▶ Auto-discriminate 	Ignore addon
Addon 5	Decide whether to decode EAN-8 with addon 5. <ul style="list-style-type: none"> ▶ Ignore Addon ▶ Auto-discriminate 	Ignore addon
Transmit Check Digit	Decide whether to include the check digit in the data being transmitted.	Enable
Convert to EAN-13	Checkbox to enable converting EAN-8 to EAN-13 format.	Disable
EAN-13		Enable
EAN-13	Switch to enable EAN-13 decoding.	Enable
Bookland EAN	Checkbox to enable ISBN decoding. If enabled, select Bookland ISBN Format in the drop-down box below.	Disable
Bookland ISBN Format	Decodes Bookland data starting with 978 in 10-digit format along with the Bookland check digit, or Bookland data starting with 978/979 in 13-digit format.	Bookland ISBN-10
Addon 2	Decide whether to decode EAN-13 with addon 2. <ul style="list-style-type: none"> ▶ Ignore Addon ▶ Auto-discriminate 	Ignore addon
Addon 5	Decide whether to decode EAN-13 with addon 5. <ul style="list-style-type: none"> ▶ Ignore Addon ▶ Auto-discriminate 	Ignore addon
Transmit Check Digit	Decide whether to include the EAN-13 check digit (the last character in the barcode) in the data being transmitted.	Enable
ISSN EAN	Checkbox to enable ISSN EAN decoding.	Disable
UPC-A		Enable
UPC-A	Switch to enable UPC-A decoding.	Enable
Addon 2	Decide whether to decode UPC-A with addon 2. <ul style="list-style-type: none"> ▶ Ignore Addon ▶ Auto-discriminate 	Ignore addon
Addon 5	Decide whether to decode UPC-A with addon 5. <ul style="list-style-type: none"> ▶ Ignore Addon ▶ Auto-discriminate 	Ignore addon

Preamble	Decide whether to include the UPC-A preamble System Character (and Country Code) in the data being transmitted. <ul style="list-style-type: none"> ▶ No transmit: transmits none of the above ▶ Transmit System Character: transmits system number only ▶ Transmit Sys. Character and Country Code: transmits system number and country code 	Transmit System Character
Transmit Check Digit	Decide whether to include the UPC-A check digit (the last character in the barcode) in the data being transmitted.	Enable
Convert to EAN-13	Checkbox to enable converting EAN-8 to EAN-13 format.	Disable
UPC-E		Enable
UPC-E	Switch to enable UPC-E decoding.	Enable
Addon 2	Decide whether to decode UPC-E with addon 2. <ul style="list-style-type: none"> ▶ Ignore Addon ▶ Auto-discriminate 	Ignore addon
Addon 5	Decide whether to decode UPC-E with addon 5. <ul style="list-style-type: none"> ▶ Ignore Addon ▶ Auto-discriminate 	Ignore addon
Preamble	Decide whether to include the UPC-E preamble System Character (and Country Code) in the data being transmitted. <ul style="list-style-type: none"> ▶ No transmit: transmits none of the above ▶ Transmit System Character: transmits system number only ▶ Transmit Sys. Character and Country Code: transmits system number and country code 	Transmit System Character
Convert to UPC-A	The UPC-E barcode will be expanded into UPC-A format, and the next process will follow the settings configured for UPC-A.	Disable
Transmit Check Digit	Decide whether to include the UPC-E1 check digit (the last character in the barcode) in the data being transmitted.	Enable
UPC-E1		Disable
UPC-E1	Switch to enable UPC-E1 decoding.	Disable
Addon 2	Decide whether to decode UPC-E1 with addon 2. <ul style="list-style-type: none"> ▶ Ignore Addon ▶ Auto-discriminate 	Ignore addon
Addon 5	Decide whether to decode UPC-E1 with addon 5. <ul style="list-style-type: none"> ▶ Ignore Addon ▶ Auto-discriminate 	Ignore addon

Preamble	Decide whether to include the UPC-E1 preamble System Character (and Country Code) in the data being transmitted. <ul style="list-style-type: none"> ▶ No transmit: transmits none of the above ▶ Transmit System Character: transmits system number only ▶ Transmit Sys. Character and Country Code: transmits system number and country code 	Transmit System Character
Convert to UPC-A	The UPC-E1 barcode will be expanded into UPC-A format, and the next process will follow the settings configured for UPC-A.	Disable
Transmit Check Digit	Decide whether to include the UPC-E1 check digit (the last character in the barcode) in the data being transmitted.	Enable
Coupon Code		
Coupon Code	Switch to enable Coupon Code decoding.	Disable

2D SYMBOLOGIES

Symbology	Description	Default						
Aztec		Enable						
Aztec	Switch to enable Aztec decoding.	Enable						
Data Matrix		Enable						
Data Matrix	Switch to enable Data Matrix decoding.	Enable						
Decode Mirror Image	<p>Switch to enable decode mirror images.</p> <table border="1"> <tr> <td>Never</td> </tr> <tr> <td>Does not decode Data Matrix barcodes that are mirror images.</td> </tr> <tr> <td>Always</td> </tr> <tr> <td>Decodes Data Matrix barcodes that are mirror images.</td> </tr> <tr> <td>Auto</td> </tr> <tr> <td>Decodes both mirrored and unmirrored Data Matrix barcodes.</td> </tr> </table>	Never	Does not decode Data Matrix barcodes that are mirror images.	Always	Decodes Data Matrix barcodes that are mirror images.	Auto	Decodes both mirrored and unmirrored Data Matrix barcodes.	Never
Never								
Does not decode Data Matrix barcodes that are mirror images.								
Always								
Decodes Data Matrix barcodes that are mirror images.								
Auto								
Decodes both mirrored and unmirrored Data Matrix barcodes.								
Separator Character	Enable the function code character separator, which is used to separate data fields of variable length and application identifiers of subsequent data fields in concatenated data strings.	None						
Maxicode		Enable						
MicroPDF417		Disable						
MicroPDF417	Switch to enable MicroPDF417 decoding.	Disable						
Code 128 Emulation	<p>Transmit data from certain Micro PDF 417 barcodes as if it was encoded in Code 128 barcodes.</p> <ul style="list-style-type: none"> ▶ Transmit AIM code ID character in Miscellaneous options must be enabled first. <p>When applied, the MicroPDF417 barcodes are transmitted with one of these prefixes:</p> <table border="1"> <tr> <td>The first codeword of MicroPDF417 is 903-905:</td> </tr> <tr> <td>The original Code ID "]L3" will be changed to "]C1".</td> </tr> <tr> <td>The first codeword of MicroPDF417 is 908 or 909:</td> </tr> <tr> <td>The original Code ID "]L4" will be changed to "]C2".</td> </tr> </table>	The first codeword of MicroPDF417 is 903-905:	The original Code ID "]L3" will be changed to "]C1".	The first codeword of MicroPDF417 is 908 or 909:	The original Code ID "]L4" will be changed to "]C2".	Disable		
The first codeword of MicroPDF417 is 903-905:								
The original Code ID "]L3" will be changed to "]C1".								
The first codeword of MicroPDF417 is 908 or 909:								
The original Code ID "]L4" will be changed to "]C2".								

	<p>The first codeword of MicroPDF417 is 910 or 911:</p> <p>The original Code ID "]L5" will be changed to "]C0".</p>	
MicroQR		Enable
PDF417		Enable
QR Code		Enable
QR Code	Switch to enable QR Code decoding.	Enable

MISCELLANEOUS

2D Engine	Description	Default
Miscellaneous Options		
Transmit AIM Code ID	<p>Decide whether to include AIM Code ID in the data.</p> <p>Each AIM Code ID contains a three-character string "]cm":</p> <ul style="list-style-type: none"> ▶] = Flag Character (ASCII 93) ▶ c = Code Character ▶ m = Modifier Character ▶ Refer to AIM Code ID – Code Characters. 	Disable