

Honeywell

Xenon™ XP 195X Series

Area-Imaging Scanners and Bases

Scanner Models: 1950g, 1950h, 1952g, 1952h, 1952g-BF, 1952h-BF

Base Models: CCB01-010BT, CCB01-010BT-BF, CCB-H-010BT, CCB-H-010BT-BF



User Guide

Disclaimer

Honeywell International Inc. (“HII”) reserves the right to make changes in specifications and other information contained in this document without prior notice, and the reader should in all cases consult HII to determine whether any such changes have been made. The information in this publication does not represent a commitment on the part of HII.

HII shall not be liable for technical or editorial errors or omissions contained herein; nor for incidental or consequential damages resulting from the furnishing, performance, or use of this material. HII disclaims all responsibility for the selection and use of software and/or hardware to achieve intended results.

This document contains proprietary information that is protected by copyright. All rights are reserved. No part of this document may be photocopied, reproduced, or translated into another language without the prior written consent of HII.

Copyright © 2018-2021 Honeywell International Inc. All rights reserved.

Web Address: sps.honeywell.com

Trademarks

Microsoft® Windows® and the Windows logo are trademarks or registered trademarks of Microsoft Corporation.

The Bluetooth® word mark and logos are owned by Bluetooth SIG, Inc.

Apple is a trademark of Apple Inc., registered in the U.S. and other countries.

Other product names or marks mentioned in this document may be trademarks or registered trademarks of other companies and are the property of their respective owners.

Patents

For patent information, refer to www.hsmpats.com.

TABLE OF CONTENTS

Customer Support	xvii
Technical Assistance	xvii
Product Service and Repair	xvii
Limited Warranty	xvii
Chapter 1 - Get Started	1
About This Manual.....	1
Unpack Your Device.....	1
Connect the Device.....	2
Connect with USB.....	2
Connect with Keyboard Wedge	4
Connect with RS232 Serial Port	6
Connect with RS485.....	8
Mount a CCB01-010BT/CCB01-010BT-BF Charge Base.....	10
Mount a CCB-H-010BT/CCB-H-010BT-BF Charge Base.....	10
Horizontal Mount.....	11
Vertical Mount	12
Reading Techniques.....	12
Menu Barcode Security Settings	13
Set Custom Defaults.....	13
Reset the Custom Defaults.....	13
Chapter 2 - Program the Interface	15
Introduction.....	15
Program the Interface - Plug and Play.....	15

Keyboard Wedge	15
Laptop Direct Connect	16
RS232 Serial Port.....	16
RS485.....	16
USB IBM SurePos	17
USB PC or Macintosh Keyboard	18
USB HID.....	18
USB Serial.....	18
CTS/RTS Emulation	19
ACK/NAK Mode.....	19
Verifone [®] Ruby Terminal.....	19
Gilbarco [®] Terminal.....	20
Honeywell Bioptic Aux Port	20
Datalogic [™] Magellan [®] Aux Port.....	20
Wincor Nixdorf Terminal.....	21
Wincor Nixdorf Beetle [™] Terminal	21
Wincor Nixdorf RS232 Mode A.....	22
Keyboard Country Layout.....	22
Keyboard Wedge Modifiers	29
ALT Mode.....	29
Keyboard Style	30
Keyboard Conversion	31
Control Character Output.....	32
Keyboard Modifiers.....	32
RS232 Modifiers	34
RS232 Baud Rate	34
RS232 Word Length: Data Bits, Stop Bits, and Parity	35
RS232 Receiver Time-Out	36
RS232 Handshake	36
RS232 Timeout.....	37
XON/XOFF.....	37
ACK/NAK	38

Scanner to Bioptic Communication	38
Scanner-Bioptic Packet Mode.....	38
Scanner-Bioptic ACK/NAK Mode.....	39
Scanner-Bioptic ACK/NAK Timeout	39

Chapter 3 - Cordless System Operation41

How the Cordless Charge Base/Access Point Works.....	41
Link the Scanner to a Charge Base.....	41
Link the Scanner to an Access Point	42
Replace a Linked Scanner	42
Communication Between the Cordless System and the Host.....	42
Program the Scanner and Base or Access Point	43
RF (Radio Frequency) Module Operation.....	43
System Conditions.....	44
Page Button.....	45
Page Button and Presentation Modes	45
Temporary Streaming Presentation Timeout.....	46
Presentation Mode in the Base.....	46
Charge Information.....	46
Battery Information for the Xenon XP 1952g/1952h	47
Battery Recommendations	47
Safety Precautions for Lithium Batteries.....	47
Instant Charge Pack Information for the Xenon XP 1952g-BF/Xenon XP 1952h-BF	48
Beeper and LED Sequences and Meaning	48
Scanner Communication and Scanning.....	48
Scanner Charge Pack Status	49
Base/Access Point Communication and Scanning	49
Base Power Communication Indicator	50
Base Charge Status	50
Low Power Alerts	50
Low Power Alert Range.....	51
Low Power Alert Flash Number.....	51

Low Power Alert Repeat	51
Low Power Alert Beep	52
Reset Scanner	52
Scan While in Base Cradle.....	52
Base Charge Modes	53
Page	54
Page Mode	54
Page Pitch	54
Error Indicators.....	55
Beeper Pitch - Base Error.....	55
Number of Beeps - Base Error	55
Scanner Report.....	56
Scanner Address	56
Base or Access Point Address	56
Scanner Modes.....	56
Charge Only Mode	56
Charge and Link Mode.....	57
Linked Modes	57
Unlink the Scanner.....	58
Override Locked Scanner	58
Out-of-Range Alarm.....	58
Alarm Sound Type	59
Scanner Power Time-Out Timer.....	60
Flexible Power Management.....	61
Xenon XP 1952g/1952h	61
Xenon XP 1952g-BF/1952h-BF	62
Batch Mode.....	62
Batch Mode Beep	63
Batch Mode Storage	63
Batch Mode Quantity.....	64
Enter Quantities.....	64
Batch Mode Output Order	66
Total Records.....	66

Delete Last Code.....	67
Clear All Codes.....	67
Transmit Records to Host.....	67
Batch Mode Transmit Delay.....	67
Multiple Scanner Operation.....	68
Scanner Name.....	68
Application Work Groups.....	69
Application Work Group Selection.....	70
Reset the Factory Defaults: All Application Work Groups.....	70
Reset the Custom Defaults: All Application Work Groups.....	71
Use the Scanner with Bluetooth Devices.....	71
Bluetooth Secure Simple Pairing (SSP).....	71
Bluetooth HID Keyboard Connect.....	72
Virtual Keyboard.....	74
Bluetooth HID Keyboard Disconnect.....	74
Pair with Bluetooth Low Energy (BLE) Devices.....	74
Bluetooth Serial Port - PCs/Laptops.....	74
PDAs/Mobility Systems Devices.....	75
Change the Scanner's Bluetooth PIN Code.....	75
Minimize Bluetooth/ISM Band Network Activity.....	75
Auto Reconnect Mode.....	75
Maximum Link Attempts.....	76
Relink Time-Out.....	77
Bluetooth/ISM Network Activity Examples.....	77
Host Acknowledgment.....	78
Host ACK On/Off.....	79
Host ACK Timeout.....	80
Host ACK Responses.....	80

Chapter 4 - Input/Output Settings81

Power Up Beeper.....	81
Beep on BEL Character.....	82
Trigger Click.....	82

Good Read and Error Indicators	82
Beeper – Good Read.....	82
Beeper Volume – Good Read	83
Beeper Pitch – Good Read	83
Vibrate – Good Read.....	84
Beeper Pitch – Error	84
Beeper Duration – Good Read.....	85
LED – Good Read	85
Number of Beeps – Good Read.....	85
Number of Beeps – Error.....	85
Good Read Delay	86
User-Specified Good Read Delay.....	86
Trigger Modes	87
Manual Trigger.....	87
Trigger Toggle	87
Serial Trigger	89
Presentation Mode.....	89
Triggered Presentation Mode.....	90
Presentation LED Behavior after Decode.....	90
Presentation Centering.....	90
In-Stand Sensor Mode.....	92
Poor Quality Codes.....	92
Poor Quality 1D Codes	92
Poor Quality PDF Codes	93
Low Resolution PDF Codes	93
CodeGate™.....	94
Streaming Presentation™ Mode	94
Streaming Presentation In-Stand	95
Hands Free Time-Out.....	95
Reread Delay.....	95
User-Specified Reread Delay.....	96
2D Reread Delay	96
Character Activation.....	97

Activation Character.....	97
End Character Activation After Good Read.....	97
Character Activation Timeout.....	98
Character Deactivation.....	98
Deactivation Character.....	98
Illumination Lights.....	99
Aimer Delay.....	99
User-Specified Aimer Delay.....	100
Aimer Mode.....	100
Centering.....	100
Single Code Centering.....	101
Custom Centering.....	101
Preferred Symbology.....	102
High Priority Symbology.....	103
Low Priority Symbology.....	103
Preferred Symbology Time-out.....	104
Preferred Symbology Default.....	104
Output Sequence Overview.....	104
Output Sequence Editor.....	104
To Add an Output Sequence.....	104
Output Sequence Editor Commands.....	105
Enter Output Sequence.....	108
Partial Sequence.....	109
Good Read Tone - Output Sequences.....	114
Multiple Symbols.....	114
No Read.....	115
Video Reverse.....	115
Working Orientation.....	116

Chapter 5 - Healthcare Settings 117

Quiet Operations - Combination Codes.....	117
Silent Mode with Flashing LED.....	117
Silent Mode with Long LED.....	118

Very Low Beeper (Nighttime Mode).....	118
Low Beeper (Daytime Mode)	119
Quiet Operations - LED and Volume Settings	119
Linking LED Colors and Sound	119
Number of LED Flashes	120
LED Flash Rate.....	120
LED Solid (No Flash).....	121
Page Volume Control.....	121
Out-of-Range Alarm Volume.....	122
Out-of-Range Delay.....	123

Chapter 6 - Data Edit125

Prefix/Suffix Overview	125
Points to Keep In Mind	125
Add a Prefix or Suffix:.....	126
Example: Add a Tab Suffix to All Symbolologies.....	126
Clear One or All Prefixes or Suffixes	126
Add a Carriage Return Suffix to All Symbolologies	127
Prefix Selections.....	127
Suffix Selections.....	127
Function Code Transmit.....	128
Intercharacter, Interfunction, and Intermesssage Delays.....	128
Intercharacter Delay	128
User Specified Intercharacter Delay.....	129
Interfunction Delay	129
Intermesssage Delay.....	130

Chapter 7 - Data Format131

Data Format Editor Introduction.....	131
Show Data Format.....	132
Add a Data Format.....	132
Other Programming Selections.....	133
Terminal ID Table.....	134

Data Format Editor Commands	134
Send Commands	134
Move Commands.....	140
Search Commands.....	141
Miscellaneous Commands	144
Data Formatter.....	147
Data Format Non-Match Error Tone.....	148
Primary/Alternate Data Formats	149
Single Scan Data Format Change.....	149

Chapter 8 - Symbologies..... 151

All Symbologies.....	152
Message Length Description	152
Codabar.....	152
Code 39	155
Interleaved 2 of 5.....	158
NEC 2 of 5	160
Code 93	161
Straight 2 of 5 Industrial (three-bar start/stop)	163
Straight 2 of 5 IATA (two-bar start/stop)	164
Matrix 2 of 5	165
Code 11	166
Code 128	167
ISBT 128 Concatenation.....	167
GS1-128	169
Telepen	170
UPC-A	171
UPC-A/EAN-13 with Extended Coupon Code	173
Coupon GS1 DataBar Output.....	174
UPC-E0	175
UPC-E1	177
EAN/JAN-13.....	178

ISBN Translate.....	185
EAN/JAN-8.....	185
MSI.....	187
GS1 DataBar Omnidirectional.....	189
GS1 DataBar Limited	190
GS1 DataBar Expanded	190
Trioptic Code.....	191
Codablock A	191
Codablock F	192
Label Code.....	193
PDF417	193
MacroPDF417	194
MicroPDF417	194
GS1 Composite Codes	195
GS1 Emulation.....	196
TCIF Linked Code 39 (TLC39)	197
QR Code.....	198
DotCode.....	200
Digimarc Barcode™	201
Data Matrix.....	202
MaxiCode	204
Aztec Code	205
Chinese Sensible (Han Xin) Code	206
Postal Codes - 2D	207
Planet Code Check Digit.....	210
Postnet Check Digit.....	211
Australian Post Interpretation.....	211
Postal Codes - Linear	212
China Post (Hong Kong 2 of 5)	212
Korea Post	213

Chapter 9 - Imaging Commands	215
Single-Use Basis	215
Command Syntax.....	215
Image Snap - IMGSNP.....	216
IMGSNP Modifiers	216
Image Ship - IMGSHIP	219
IMGSHIP Modifiers	220
Image Size Compatibility.....	227
Intelligent Signature Capture - IMGBOX.....	228
Signature Capture Optimize	228
IMGBOX Modifiers	229
RF Default Imaging Device	233
 Chapter 10 - Utilities	 235
To Add a Test Code I.D. Prefix to All Symbologies.....	235
Show Software Revision	235
Test Menu.....	235
TotalFreedom.....	236
Application Plug-Ins (Apps).....	236
EZConfig for Scanning Introduction	237
Configure with EZConfig for Scanning.....	237
Reset the Factory Defaults	238
 Chapter 11 - Serial Programming Commands.....	 239
Conventions	239
Menu Command Syntax.....	239
Query Commands	240
Trigger Commands.....	242
Reset the Custom Defaults	243
Menu Commands	244

Chapter 12 - Product Specifications275

Xenon XP 1950g/1950h Corded Scanner Product Specifications	275
Xenon XP 1952g/1952h Cordless Scanner Product Specifications	276
Xenon XP 1952g-BF/1952h-BF Scanner Product Specifications	278
CCB01-010BT/CCB01-010BT-BF Charge Base Product Specifications	279
CCB-H-010BT/CCB-H-010BT-BF Charge Base Product Specifications	280
Depth of Field Charts	281
1950g/1952g/1952g-BF Typical Performance.....	281
1950g/1952g/1952g-BF Guaranteed Performance.....	282
1950h/1952h/1952h-BF Typical Performance	283
1950h/1952h/1952h-BF Guaranteed Performance	284
Standard Connector Pinouts	284
Keyboard Wedge.....	284
Serial Output.....	285
RS485 Output.....	285
USB	286
Required Safety Labels	287
Scanner	287
CCB01-010BT/CCB01-010BT-BF Base.....	288
CCB-H-010BT/CCB-H-010BT-BF Base.....	289

Chapter 13 - Maintenance and Troubleshooting291

Repairs	291
Maintenance.....	291
Clean the Scanner.....	291
About Disinfectant-ready Models	292
Inspect Cords and Connectors	292
Replace Cables in Corded Scanners	292
Replace an Interface Cable	293
Replace Cables and Batteries in Cordless Systems.....	293
Replace an Interface Cable in a Base.....	293

Change a Scanner Battery	294
Troubleshoot a Corded Scanner.....	294
Troubleshoot a Cordless System.....	295
Troubleshoot a Base	295
Troubleshoot a Cordless Scanner	295
Chapter A - Reference Charts	297
Symbology Charts.....	297
Linear Symbologies	297
2D Symbologies	298
Postal Symbologies	299
ASCII Conversion Chart (Code Page 1252)	300
Lower ASCII Reference Table.....	301
ISO 2022/ISO 646 Character Replacements	304
Keyboard Key References.....	307
Sample Symbols.....	309
Programming Chart	311

Customer Support

Technical Assistance

To search our knowledge base for a solution or to log in to the Technical Support portal and report a problem, go to sps.honeywell.com and then select **Support > Technician Support**.

For our latest contact information, see sps.honeywell.com and then select **Support > Global Locations**.

Product Service and Repair

Honeywell International Inc. provides service for all of its products through service centers throughout the world. To obtain warranty or non-warranty service, return your product to Honeywell (postage paid) with a copy of the dated purchase record. To learn more, go to sps.honeywell.com and then select **Support > Return Material Authorization**.

Limited Warranty

For warranty information, go to sps.honeywell.com and then select **Support > Warranties**.

About This Manual

This User Guide provides installation and programming instructions for the Xenon™ XP 1950 corded area-imaging scanners and the Xenon XP 1952 cordless area-imaging scanners. Product specifications, dimensions, warranty, and customer support information are also included.

Honeywell barcode scanners are factory programmed for the most common terminal and communications settings. If you need to change these settings, programming is accomplished by scanning the barcodes in this guide.

An asterisk (*) next to an option indicates the default setting.

Unpack Your Device

After you open the shipping carton containing the product, take the following steps:

- Check for damage during shipment. Report damage immediately to the carrier who delivered the carton.
- Make sure the items in the carton match your order.
- Save the shipping container for later storage or shipping.

Connect the Device

Connect with USB

A scanner or a cordless base can be connected to the USB port of a computer.

1. Connect the appropriate interface cable to the device first, then to the computer.

Corded Xenon XP Scanner USB Connection:

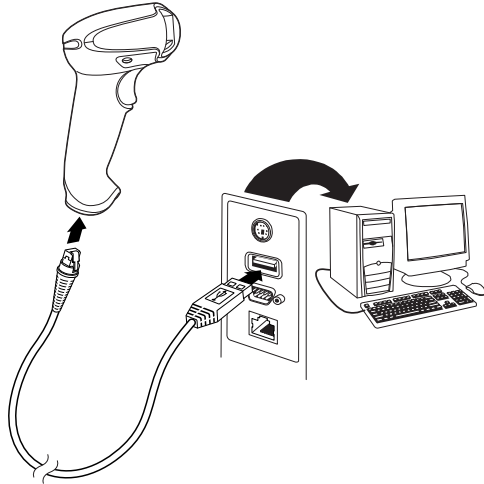

Note: The power supply must be ordered separately, if needed.

2. If you are connecting a CCB01-010BT/CCB01-010BT-BF or CCB-H-010BT/CCB-H-010BT-BF base horizontally, make sure the cables are secured in the wireways in the bottom of the cordless base and the base sits flat on a horizontal surface. If you are connecting a CCB-H-010BT/CCB-H-010BT-BF Base vertically, see [Mount a CCB-H-010BT/CCB-H-010BT-BF Charge Base](#) on page 10.

CCB01-010BT/CCB01-010BT-BF Base USB Connection:

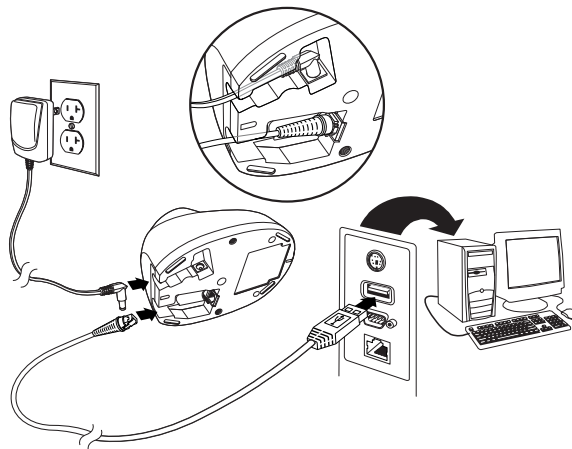

CCB-H-010BT/CCB-H-010BT-BF Base USB Connection:

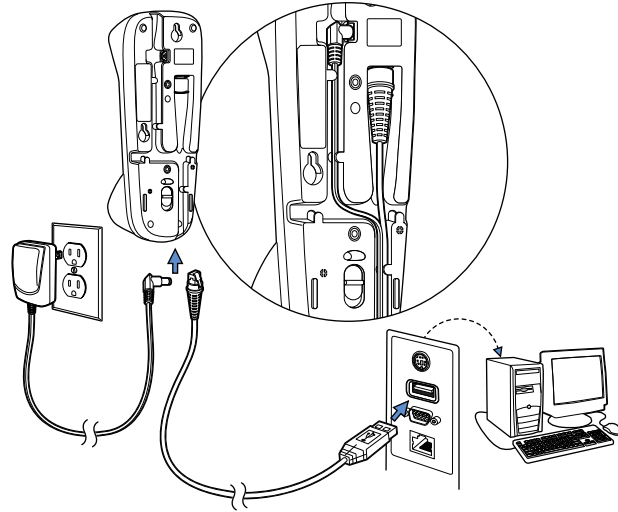

3. The scanner beeps.
4. Verify the scanner or cordless base operation by scanning a barcode from the [Sample Symbols](#), beginning on page 309.

The unit defaults to a USB PC Keyboard. Refer to [page 18](#) for other USB terminal settings.

Connect with Keyboard Wedge

A scanner or cordless base can be connected between the keyboard and PC as a “keyboard wedge,” where the scanner provides data output that is similar to keyboard entries. The following is an example of a keyboard wedge connection:

1. Turn off power and disconnect the keyboard cable from the back of the terminal/computer.
2. Connect the appropriate interface cable to the device and to the terminal/computer.

Corded Xenon XP Scanner Keyboard Wedge Connection:

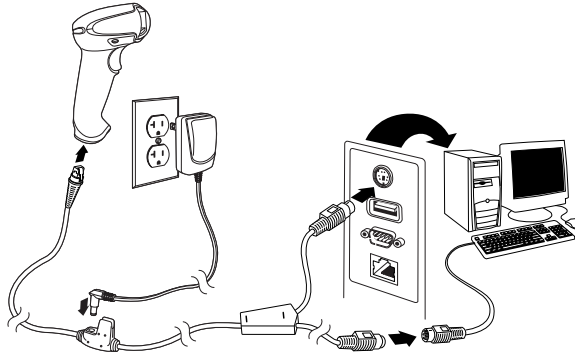

Note: *The power supply must be ordered separately, if needed.*

3. If you are connecting a CCB01-010BT/CCB01-010BT-BF or CCB-H-010BT/CCB-H-010BT-BF base horizontally, make sure the cables are secured in the wireways in the bottom of the cordless base and the base sits flat on a horizontal surface. If you are connecting a CCB-H-010BT/CCB-H-010BT-BF Base vertically, see [Mount a CCB-H-010BT/CCB-H-010BT-BF Charge Base](#) on page 10.

CCB01-010BT/CCB01-010BT-BF Base Keyboard Wedge Connection:

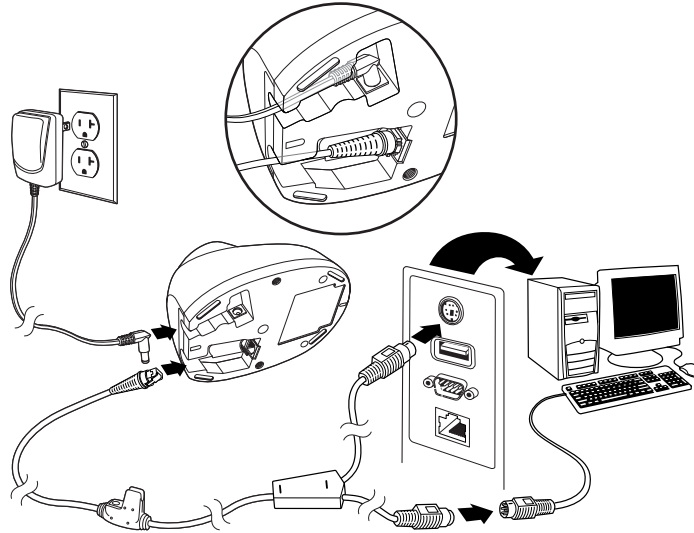

CCB-H-010BT/CCB-H-010BT-BF Base Keyboard Wedge Connection:

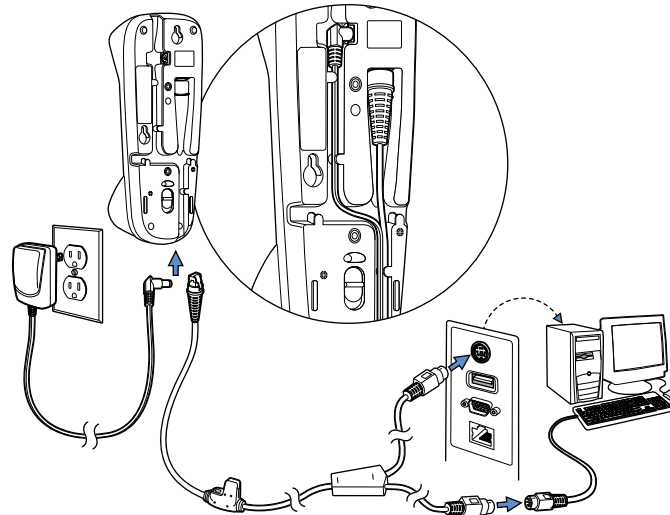

4. Turn the terminal/computer power back on. The scanner beeps.
5. Verify the scanner or cordless base operation by scanning a barcode from the [Sample Symbols](#), beginning on page 309.

The unit defaults to an IBM PC AT and compatibles keyboard wedge interface with a USA keyboard. A carriage return (CR) suffix is added to barcode data.

Connect with RS232 Serial Port

1. Turn off power to the terminal/computer.
2. Connect the appropriate interface cable to the scanner.

Note: For the scanner or cordless base to work properly, you must have the correct cable for your type of terminal/computer.

Corded Xenon XP Scanner RS232 Serial Port Connection:

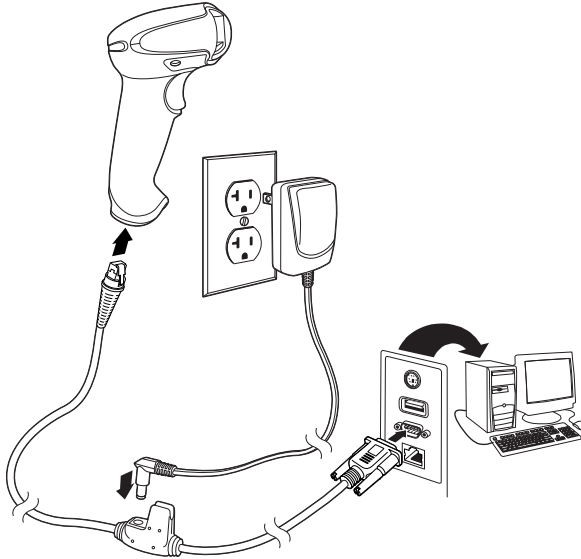

Note: The power supply must be ordered separately, if needed.

3. If you are connecting a CCB01-010BT/CCB01-010BT-BF or CCB-H-010BT/CCB-H-010BT-BF base horizontally, make sure the cables are secured in the wireways in the bottom of the cordless base and the base sits flat on a horizontal surface. If you are connecting a CCB-H-010BT/CCB-H-010BT-BF

Base vertically, see [Mount a CCB-H-010BT/CCB-H-010BT-BF Charge Base](#) on page 10.

CCB01-010BT/CCB01-010BT-BF Base RS232 Serial Port Connection:

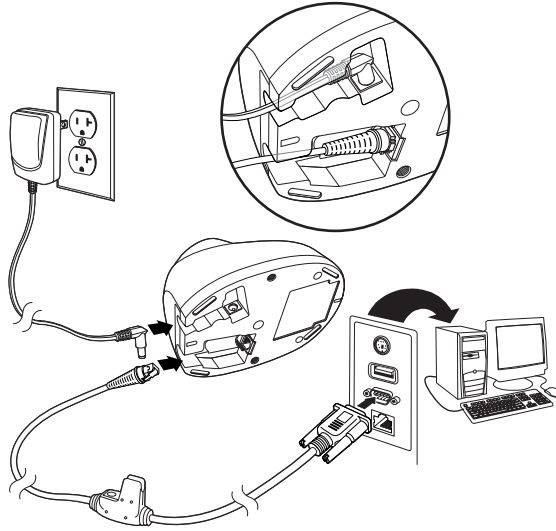

CCB-H-010BT/CCB-H-010BT-BF Base RS232 Serial Port Connection:

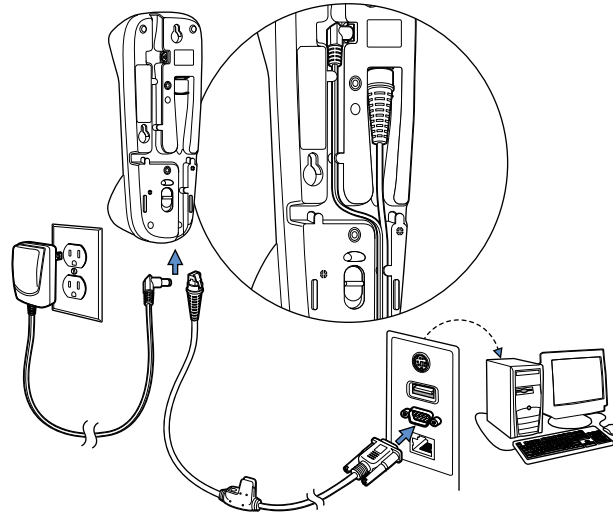

4. Plug the serial connector into the serial port on your computer. Tighten the two screws to secure the connector to the port.
5. Once the scanner or cordless base has been fully connected, power up the computer.

This interface programs 115,200 baud, 8 data bits, no parity, and 1 stop bit.

Connect with RS485

A Xenon scanner or cordless base can be connected for an IBM POS terminal interface.

1. Connect the appropriate interface cable to the device, then to the computer.

Corded Xenon XP Scanner RS485 Connection:

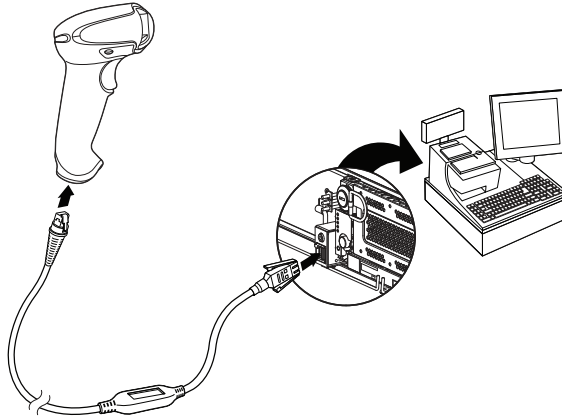

Note: *The power supply must be ordered separately, if needed.*

2. If you are connecting a CCB01-010BT/CCB01-010BT-BF or CCB-H-010BT/CCB-H-010BT-BF base horizontally, make sure the cables are secured in the wireways in the bottom of the cordless base and the base sits flat on a horizontal surface. If you are connecting a CCB-H-010BT/CCB-H-010BT-BF Base vertically, see [Mount a CCB-H-010BT/CCB-H-010BT-BF Charge Base](#) on page 10.

CCB01-010BT/CCB01-010BT-BF Base RS485 Connection:

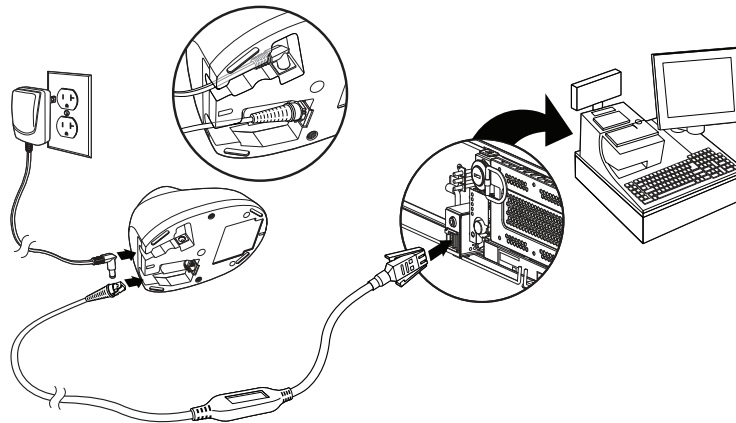

CCB-H-010BT/CCB-H-010BT-BF Base RS485 Connection:

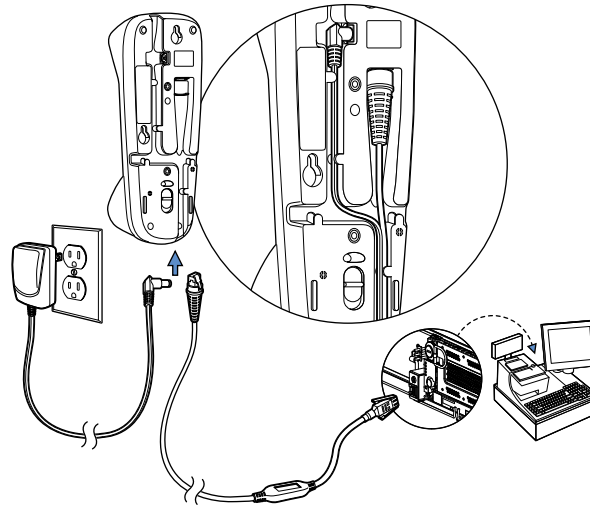

3. Turn the terminal/computer power back on. The scanner beeps.
4. Verify the scanner or cordless base operation by scanning a barcode from the [Sample Symbols](#), beginning on page 309. The scanner beeps once.

For further RS485 settings, refer to [RS485](#), page 16.

Mount a CCB01-010BT/CCB01-010BT-BF Charge Base

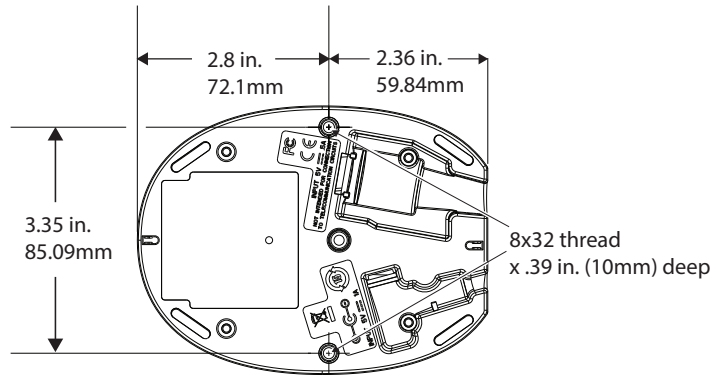

Mount a CCB-H-010BT/CCB-H-010BT-BF Charge Base

The CCB-H-010BT/CCB-H-010BT-BF Base can be mounted on either a horizontal or vertical surface. Route the cables through the top, bottom, or sides of the base and secure the cables in the wireways.

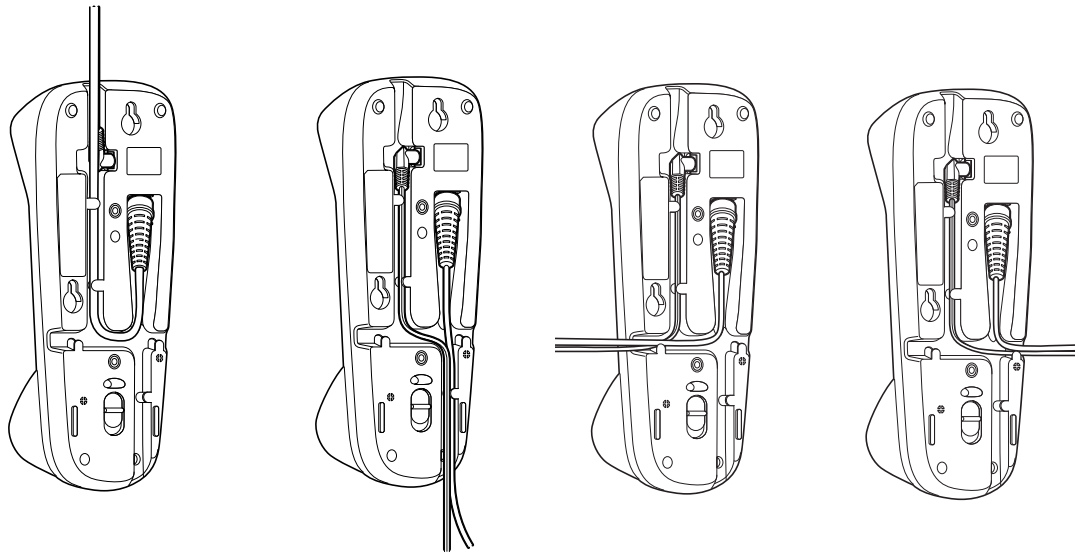

When mounted on a vertical surface, a locking system is used to secure the scanner when it is in the stand. When mounted on a horizontal surface, the locking mechanism should be set to unlocked (pushed up). When mounted on a vertical surface, the locking mechanism should be set to locked (pushed down).

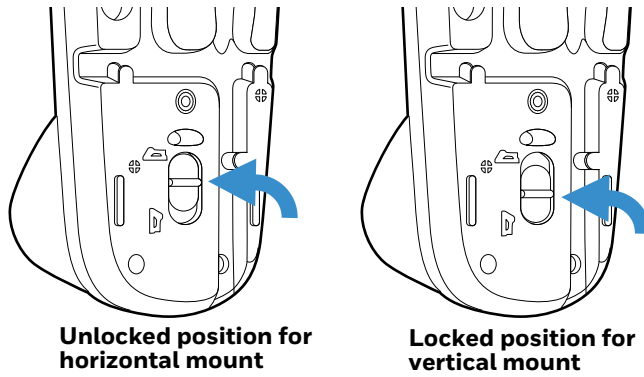

Use 30mm screws, appropriate for the mounting surface material, to mount the base securely.

Horizontal Mount

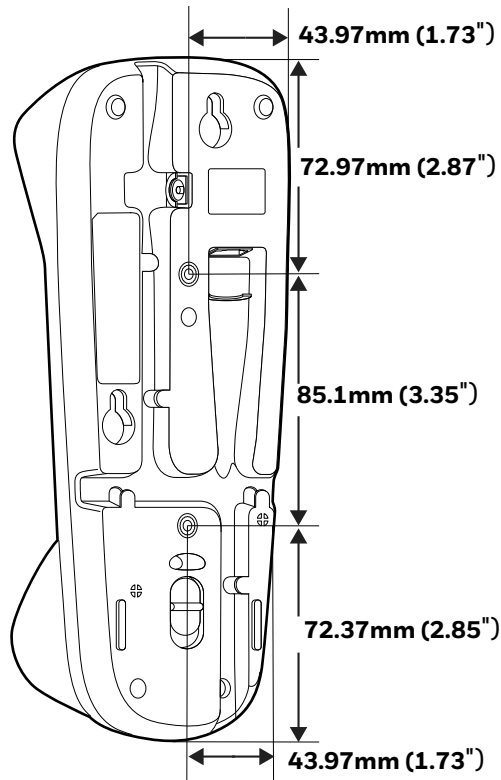

Vertical Mount

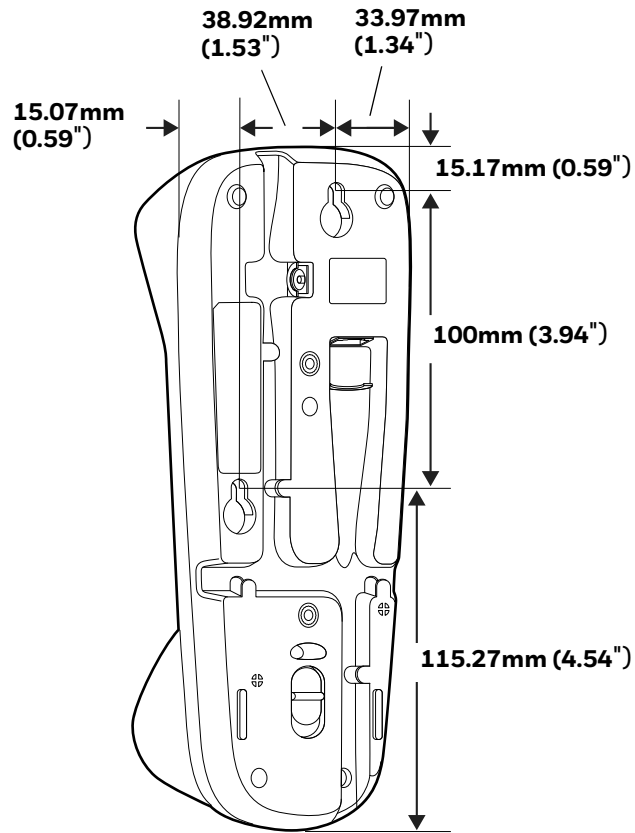

Reading Techniques

The Xenon XP scanners have a view finder that projects a bright red aiming beam that corresponds to the scanner's horizontal field of view. The aiming beam should be centered over the barcode, but it can be positioned in any direction for a good read.

Linear Barcodes

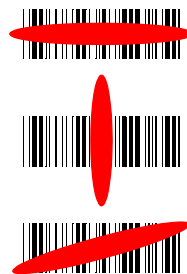

2D Matrix Symbol



Menu Barcode Security Settings

Honeywell scanners are programmed by scanning menu barcodes or by sending serial commands to the scanner. If you want to restrict the ability to scan menu codes, you can use the Menu Barcode Security settings. Contact the nearest technical support office (see [Technical Assistance](#) on page xvii) for further information.

Set Custom Defaults

You have the ability to create a set of menu commands as your own, custom defaults. To do so, scan the **Set Custom Defaults** barcode below before scanning the menu commands for your custom defaults. If a menu command requires scanning numeric codes from the [Programming Chart](#), beginning on page 311, then a **Save** code, that entire sequence will be saved to your custom defaults. When you have entered all the commands you want to save for your custom defaults, scan the **Save Custom Defaults** barcode.



Note: When using a cordless system, the Custom Defaults settings apply to all workgroups. Scanning the **Save Defaults** barcode also causes both the scanner and the base or Access Point to perform a reset and become unlinked. The scanner must be placed in its base to re-establish the link before any setup codes are entered. If using an Access Point, the linking barcode must be scanned. See [Cordless System Operation](#) beginning on page 41 for additional information.

You may have a series of custom settings and want to correct a single setting. To do so, just scan the new setting to overwrite the old one. For example, if you had previously saved the setting for Beeper Volume at Low to your custom defaults, and decide you want the beeper volume set to High, just scan the **Set Custom Defaults** barcode, then scan the Beeper Volume High menu code, and then **Save Custom Defaults**. The rest of the custom defaults will remain, but the beeper volume setting will be updated.

Reset the Custom Defaults

If you want the custom default settings restored to your scanner, scan the **Activate Custom Defaults** barcode below. This is the recommended default barcode for most users. It resets the scanner to the custom default settings. If there are no

custom defaults, it will reset the scanner to the factory default settings. Any settings that have not been specified through the custom defaults will be defaulted to the factory default settings.



DEFAULT.

Activate Custom Defaults

Note: *If using a cordless system, scanning this barcode also causes both the scanner and the base or Access Point to perform a reset and become unlinked. The scanner must be placed in its base to re-establish the link. If using an Access Point, the linking barcode must be scanned. See [Cordless System Operation](#) beginning on page 41 for additional information.*

Introduction

This chapter describes how to program your system for the desired interface.

Program the Interface - Plug and Play

Plug and Play barcodes provide instant scanner set up for commonly used interfaces.

Note: After you scan one of the codes, power cycle the host terminal to have the interface in effect.

Keyboard Wedge

If you want your system programmed for an IBM PC AT and compatibles keyboard wedge interface with a USA keyboard, scan the barcode below. Keyboard wedge is the default interface.

Note: The following barcode also programs a carriage return (CR) suffix.



PAP_AT.

IBM PC AT and Compatibles with
CR suffix

Laptop Direct Connect

For most laptops, scanning the **Laptop Direct Connect** barcode allows operation of the scanner in parallel with the integral keyboard. The following **Laptop Direct Connect** barcode also programs a carriage return (CR) suffix and turns on Emulate External Keyboard (page 31).



RS232 Serial Port

The **RS232 Interface** barcode is used when connecting to the serial port of a PC or terminal. The following **RS232 Interface** barcode also programs a carriage return (CR) and a line feed (LF) suffix, baud rate, and data format as indicated below. It also changes the trigger mode to manual.

Option	Setting
Baud Rate	115,200 bps
Data Format	8 data bits, no parity bit, 1 stop bit



RS485

Scan one of the following “Plug and Play” codes to program the scanner for an IBM POS terminal interface.

Note: After scanning one of these codes, you must power cycle the cash register.





Each barcode above also programs the following suffixes for each symbology:

Symbology	Suffix	Symbology	Suffix
EAN 8	0C	Code 39	00 0A 0B
EAN 13	16	Interleaved 2 of 5	00 0D 0B
UPC A	0D	Code 128 *	00 0A 0B
UPC E	0A	Code 128 **	00 18 0B
		MaxiCode	00 2F 0B

* Suffixes programmed for Code 128 with IBM 4683 Port 5B, IBM 4683 Port 9B HHBCR-1, and IBM 4683 Port 17 Interfaces

** Suffixes programmed for Code 128 with IBM 4683 Port 9 HHBCR-2 Interface

USB IBM SurePos

Scan one of the following “Plug and Play” codes to program the scanner for an IBM SurePos (USB handheld scanner) or IBM SurePos (USB tabletop scanner) interface.

Note: After scanning one of these codes, you must power cycle the cash register.



Each barcode above also programs the following suffixes for each symbology:

Symbology	Suffix	Symbology	Suffix
EAN 8	0C	Code 39	00 0A 0B
EAN 13	16	Interleaved 2 of 5	00 0D 0B
UPC A	0D	Code 128	00 18 0B
UPC E	0A	Code 39	00 0A 0B

USB PC or Macintosh Keyboard

Scan one of the following codes to program the scanner for USB PC Keyboard or USB Macintosh Keyboard. Scanning these codes also adds a CR suffix.



PAP124.
USB Keyboard (PC)



PAP125.
USB Keyboard (Mac)



TRMUSB134.
USB Japanese Keyboard (PC)

USB HID

Scan the following code to program the scanner for USB HID Barcode scanners.



PAP131.
USB HID Barcode Scanner

USB Serial

If you are using a Microsoft® Windows® PC, you will need to download the latest driver from the Honeywell website (sps.honeywell.com) and then select **Support > Software and Downloads**. The driver will use the next available COM Port number. Apple® Macintosh computers recognize the scanner as a USB CDC class device and automatically use a class driver.

After the driver is downloaded, scan the following code to program the scanner to emulate a regular RS232-based COM Port.



TRMUSB130.
USB Serial

No extra configuration (e.g., baud rate) is necessary.

Note: *If you scan the USB Serial barcode either with an older Honeywell serial driver, or no driver installed, you may no longer be able to scan barcodes. If this happens, either uninstall the older driver versions and install the latest driver, or delete the specific device entry in Device Manager.*

CTS/RTS Emulation

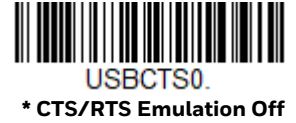

ACK/NAK Mode



Verifone[®] Ruby Terminal

Scan the following Plug and Play code to program the scanner for a Verifone Ruby terminal. This barcode sets the baud rate to 1200 bps and the data format to 8 data bits, mark parity bit, 1 stop bit. It also adds a line feed (LF) suffix and programs the following prefixes for each symbology:

Symbology	Prefix
UPC-A	A
UPC-E	A
EAN-8	FF
EAN-13	F



Gilbarco[®] Terminal

Scan the following Plug and Play code to program the scanner for a Gilbarco terminal. This barcode sets the baud rate to 2400 bps and the data format to 7 data bits, even parity, 2 stop bits. It also adds a carriage return (CR) suffix and programs the following prefixes for each symbology:

Symbology	Prefix
UPC-A	A
UPC-E	EO
EAN-8	FF
EAN-13	F



PAPGLB.

Gilbarco Settings

Honeywell Bioptic Aux Port

Scan the following Plug and Play code to program the scanner for a Honeywell bioptic scanner auxiliary port configuration. This barcode sets the baud rate to 38400 bps and the data format to 8 data bits, no parity, 1 stop bit.



PAPBIO.

Honeywell Bioptic Settings

Datalogic[™] Magellan[®] Aux Port

Scan the following Plug and Play code to program the scanner for a Datalogic Magellan auxiliary port configuration. This barcode sets the baud rate to 9600 bps and the data format to 8 data bits, no parity, 1 stop bit.



PAPMAG.

Datalogic Magellan Settings

Wincor Nixdorf Terminal

Scan the following Plug and Play code to program the scanner for a Wincor Nixdorf terminal. This barcode sets the baud rate to 9600 bps and the data format to 8 data bits, no parity, 1 stop bit.



Wincor Nixdorf Beetle™ Terminal

Scan the following Plug and Play code to program the scanner for a Wincor Nixdorf Beetle terminal. The following prefixes are programmed for each symbology:

Symbology	Prefix	Symbology	Prefix
Aztec Code	V	Interleaved 2 of 5	I
Codabar	N	MaxiCode	T
Code 93	L	MicroPDF417	S
Code 128	K	PDF417	Q
Data Matrix	R	QR Code	U
EAN-8	B	Straight 2 of 5 IATA	H
EAN-13	A	UPC-A	A0
GS1 DataBar	E	UPC-E	C
GS1-128	P	All other barcodes	M



Wincor Nixdorf RS232 Mode A

Scan the following Plug and Play code to program the scanner for a Wincor Nixdorf RS232 Mode A terminal. This barcode sets the baud rate to 9600 bps and the data format to 8 data bits, odd parity, 1 stop bit. The following prefixes are programmed for each symbology:

Symbology	Prefix	Symbology	Prefix
Code 128	K	EAN-13	A
Code 93	L	GS1-128	K
Codabar	N	Interleaved 2 of 5	I
UPC-A	A0	Straight 2 of 5 IATA	H
UPC-E	C	GS1 DataBar	E
EAN-8	B		
All other barcodes	M		



PAPWMA.

Wincor Nixdorf RS232 Mode A
Settings

Keyboard Country Layout

If your interface is USB Keyboard or Keyboard Wedge, your keyboard layout default is a US keyboard. To change this layout, scan the appropriate Keyboard Country barcode below. By default, national character replacements are used for the following characters: # \$ @ [\] ^ ' { | } ~. Refer to the ["ISO 2022/ISO 646 Character Replacements" on page A-304](#) to view the character replacements for each country.

Keyboard Countries



KBDCTY0.

* United States



KBDCTY35.

Albania



KBDCTY81.

Azeri (Cyrillic)



KBDCTY80.

Azeri (Latin)

Keyboard Countries (Continued)



KBDCTY82.
Belarus



KBDCTY33.
Bosnia



KBDCTY59.
Brazil (MS)



KBDCTY53.
Bulgaria (Latin)



KBDCTY18.
Canada (French)



KBDCTY32.
Croatia



KBDCTY1.
Belgium



KBDCTY16.
Brazil



KBDCTY52.
Bulgaria (Cyrillic)



KBDCTY54.
Canada (French legacy)



KBDCTY55.
Canada (Multilingual)



KBDCTY15.
Czech

Keyboard Countries (Continued)



KBDCTY40.
Czech (Programmers)



KBDCTY38.
Czech (QWERTZ)



KBDCTY11.
Dutch (Netherlands)



KBDCTY83.
Faroese



KBDCTY3.
France



KBDCTY4.
Germany



KBDCTY39.
Czech (QWERTY)



KBDCTY8.
Denmark



KBDCTY41.
Estonia



KBDCTY2.
Finland



KBDCTY84.
Gaelic



KBDCTY17.
Greek

Keyboard Countries (Continued)



KBDCTY64.
Greek (220 Latin)



KBDCTY65.
Greek (319 Latin)



KBDCTY63.
Greek (Latin)



KBDCTY60.
Greek (Polytonic)



KBDCTY50.
Hungarian (101 key)



KBDCTY75.
Iceland



KBDCTY61.
Greek (220)



KBDCTY62.
Greek (319)



KBDCTY66.
Greek (MS)



KBDCTY12.
Hebrew



KBDCTY19.
Hungary



KBDCTY73.
Irish

Keyboard Countries (Continued)



KBDCTY56.
Italian (142)



KBDCTY28.
Japan ASCII



KBDCTY79.
Kyrgyz (Cyrillic)



KBDCTY42.
Latvia



KBDCTY44.
Lithuania



KBDCTY34.
Macedonia



KBDCTY5.
Italy



KBDCTY78.
Kazakh



KBDCTY14.
Latin America



KBDCTY43.
Latvia (QWERTY)



KBDCTY45.
Lithuania (IBM)



KBDCTY74.
Malta

Keyboard Countries (Continued)



KBDCTY86.
Mongolian (Cyrillic)



KBDCTY20.
Poland



KBDCTY58.
Polish (Programmers)



KBDCTY25.
Romania



KBDCTY67.
Russian (MS)



KBDCTY21.
SCS



KBDCTY9.
Norway



KBDCTY57.
Polish (214)



KBDCTY13.
Portugal



KBDCTY26.
Russia



KBDCTY68.
Russian (Typewriter)



KBDCTY37.
Serbia (Cyrillic)

Keyboard Countries (Continued)



KBDCTY36.
Serbia (Latin)



KBDCTY49.
Slovakia (QWERTY)



KBDCTY31.
Slovenia



KBDCTY51.
Spanish variation



KBDCTY29.
Switzerland (French)



KBDCTY85.
Tatar



KBDCTY22.
Slovakia



KBDCTY48.
Slovakia (QWERTZ)



KBDCTY10.
Spain



KBDCTY23.
Sweden



KBDCTY6.
Switzerland (German)



KBDCTY27.
Turkey F

Keyboard Countries (Continued)



KBDCTY24.
Turkey Q



KBDCTY76.
Ukrainian



KBDCTY7.
United Kingdom



KBDCTY87.
United States (Dvorak)



KBDCTY88.
United States (Dvorak left)



KBDCTY89.
United States (Dvorak right)



KBDCTY30.
United States (International)



KBDCTY77.
Uzbek (Cyrillic)

Keyboard Wedge Modifiers

ALT Mode

If your barcode contains special characters from the extended ASCII chart, for example, an e with an accent grave (è), you will use ALT Mode. (See [Extended ASCII Characters](#) on page 301.)

Note: Scan the ALT mode barcode after scanning the appropriate Keyboard Country code.

If your keystrokes require the ALT key and 3 or 4 characters, scan the **3 Characters** or **4 Characters** barcode. The data is then output with the special character(s) for values 00-255. *Default = Off.*



KBDALT0.

* Off



KBDALT6.

3 Characters



KBDALT7.

4 Characters

Keyboard Style

This programs keyboard styles, such as Caps Lock and Shift Lock. If you have used [Keyboard Conversion](#) settings, they will override any of the following Keyboard Style settings. *Default = Regular.*

Regular is used when you normally have the Caps Lock key off.



KBDSTY0.

* Regular

Caps Lock is used when you normally have the Caps Lock key on.



KBDSTY1.

Caps Lock

Shift Lock is used when you normally have the Shift Lock key on (not common to U.S. keyboards).



KBDSTY2.

Shift Lock

Automatic Caps Lock is used if you change the Caps Lock key on and off. The software tracks and reflects if you have Caps Lock on or off. This selection can only be used with systems that have an LED that notes the Caps Lock status (AT keyboards).

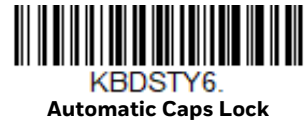

Autocaps via NumLock barcode should be scanned in countries (e.g., Germany, France) where the Caps Lock key cannot be used to toggle Caps Lock. The NumLock option works similarly to the regular Autocaps, but uses the NumLock key to retrieve the current state of the Caps Lock.

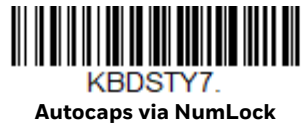

Emulate External Keyboard should be scanned if you do not have an external keyboard (IBM AT or equivalent).



Note: After scanning the Emulate External Keyboard barcode, you must power cycle your computer.

Keyboard Conversion

Alphabetic keyboard characters can be forced to be all upper case or all lowercase. So if you have the following barcode: “abc569GK,” you can make the output “ABC569GK” by scanning **Convert All Characters to Upper Case**, or to “abc569gk” by scanning **Convert All Characters to Lower Case**.

These settings override [Keyboard Style](#) selections.

Note: If your interface is a keyboard wedge, first scan the menu code for [Automatic Caps Lock](#) (page 31). Otherwise, your output may not be as expected.

Default = Keyboard Conversion Off.





Control Character Output

This selection sends a text string instead of a control character. For example, when the control character for a carriage return is expected, the output would display [CR] instead of the ASCII code of 0D. Refer to [ASCII Conversion Chart \(Code Page 1252\)](#) on page 300. Only codes 00 through 1F are converted (the first column of the chart). *Default = Off.*

Note: *Control + X (Control + ASCII) Mode overrides this mode.*



Keyboard Modifiers

This modifies special keyboard features, such as CTRL+ ASCII codes and Turbo Mode.

Control + X (Control + ASCII) Mode On: The scanner sends key combinations for ASCII control characters for values 00-1F. Windows is the preferred mode. All keyboard country codes are supported. DOS mode is a legacy mode, and it does not support all keyboard country codes. New users should use the Windows mode. Refer to [ASCII Conversion Chart \(Code Page 1252\)](#), page 300 for CTRL+ X Values.

Windows Mode Prefix/Suffix Off: The scanner sends key combinations for ASCII control characters for values 00-1F, but it does not translate prefix or suffix information.

Support ALT 3 Digit HEX Mode: The scanner sends key combinations for ASCII control characters for values 00-1F transmitted as the ALT key and 3 digits.

Default = Control + X Mode Off.



KBDCAS2.

**Windows Mode Control + X
Mode On**



KBDCAS0.

*** Control + X Mode Off**



KBDCAS1.

DOS Mode Control + X Mode On



KBDCAS3.

Windows Mode Prefix/Suffix



KBDCAS4.

**DOS Mode Control + X Mode On with
Windows Mode Prefix/Suffix**



KBDCAS5.

Supports ALT 3 Digit HEX Mode

Turbo Mode: The scanner sends characters to a terminal faster. If the terminal drops characters, do not use Turbo Mode. *Default = Off.*



KBDTMD1.

Turbo Mode On



KBDTMD0.

*** Turbo Mode Off**

Numeric Keypad Mode: Sends numeric characters as if entered from a numeric keypad. *Default = Off.*



KBDNPS1.

Numeric Keypad Mode On



KBDNPS0.

*** Numeric Keypad Mode Off**

Automatic Direct Connect Mode: This selection can be used if you have an IBM AT style terminal and the system is dropping characters. *Default = Off.*



KBDADC1.

Automatic Direct Connect
Mode On



KBDADC0.

* Automatic Direct Connect
Mode Off

RS232 Modifiers

RS232 Baud Rate

Baud Rate sends the data from the scanner to the terminal at the specified rate. The host terminal must be set for the same baud rate as the scanner. *Default = 115,200.*



232BAD0.

300



232BAD1.

600



232BAD2.

1200



232BAD3.

2400



232BAD4.

4800



232BAD5.

9600



232BAD6.
19200



232BAD7.
38400



232BAD8.
57,600



232BAD9.
* 115,200

RS232 Word Length: Data Bits, Stop Bits, and Parity

Data Bits sets the word length at 7 or 8 bits of data per character. If an application requires only ASCII Hex characters 0 through 7F decimal (text, digits, and punctuation), select 7 data bits. For applications that require use of the full ASCII set, select 8 data bits per character. *Default = 8.*

Stop Bits sets the stop bits at 1 or 2. *Default = 1.*

Parity provides a means of checking character bit patterns for validity. *Default = None.*



232WRD3.
7 Data, 1 Stop, Parity Even



232WRD0.
7 Data, 1 Stop, Parity None



232WRD6.
7 Data, 1 Stop, Parity Odd



232WRD4.
7 Data, 2 Stop, Parity Even



232WRD1.
7 Data, 2 Stop, Parity None



RS232 Receiver Time-Out

The unit stays awake to receive data until the RS232 Receiver Time-Out expires. A manual or serial trigger resets the time-out. When an RS232 receiver is sleeping, a character may be sent to wake up the receiver and reset the time-out. A transaction on the CTS line will also wake up the receiver. The receiver takes 300 milliseconds to completely come up. Change the RS232 receiver time-out by scanning the barcode below, then scanning digits from the [Programming Chart](#), beginning on page 311, then scanning **Save**. The range is 0 to 300 seconds. *Default = 0 seconds (no time-out - always on).*



RS232 Handshake

RS232 Handshaking allows control of data transmission from the scanner using software commands from the host device. When RTS/CTS is turned Off, no data flow control is used.

Flow Control, No Timeout: The scanner asserts RTS when it has data to send, and will wait indefinitely for CTS to be asserted by the host.

Two-Direction Flow Control: The scanner asserts RTS when it is OK for the host to transmit. The host asserts CTS when it is OK for the device to transmit.

Flow Control with Timeout: The scanner asserts RTS when it has data to send and waits for a delay (see [RS232 Timeout](#) on page 37) for CTS to be asserted by the host. If the delay time expires and CTS is not asserted, the device transmit buffer is cleared and scanning may resume. *Default = RTS/CTS Off.*



232CTS1.

Flow Control, No Timeout



232CTS2.

Two-Direction Flow Control



232CTS3.

Flow Control with Timeout



232CTS0.

* RTS/CTS Off

RS232 Timeout

When using **Flow Control with Timeout**, you must program the length of the delay you want to wait for CTS from the host. Set the length (in milliseconds) for a timeout by scanning the barcode below, then setting the timeout (from 1-5100 milliseconds) by scanning digits from the [Programming Chart](#), beginning on page 311, then scanning **Save**.



232DEL.

RS232 Timeout

XON/XOFF

Standard ASCII control characters can be used to tell the scanner to start sending data (XON/XOFF On) or to stop sending data (XON/XOFF Off). When the host sends the XOFF character (DC3, hex 13) to the scanner, data transmission stops. To resume transmission, the host sends the XON character (DC1, hex 11). Data transmission continues where it left off when XOFF was sent. *Default = XON/XOFF Off.*



232XON1.

XON/XOFF On



232XON0.

* XON/XOFF Off

ACK/NAK

After transmitting data, the scanner waits for an ACK character (hex 06) or a NAK character (hex 15) response from the host. If ACK is received, the communications cycle is completed and the scanner looks for more barcodes. If NAK is received, the last set of barcode data is retransmitted and the scanner waits for ACK/NAK again. Turn on the ACK/NAK protocol by scanning the **ACK/NAK On** barcode below. To turn off the protocol, scan **ACK/NAK Off**. *Default = ACK/NAK Off.*



232ACK1.

ACK/NAK On



232ACK0.

* ACK/NAK Off

Scanner to Bioptic Communication

The following settings are used to set up communication between Honeywell scanners and bioptic scanners.

Note: *The scanner's baud rate must be set to 38400 and the RS232 timeout must be set to 3000 in order to communicate with a bioptic scanner. See "RS232 Modifiers" on page 34, and [RS232 Timeout](#) on page 37 for further information.*

Scanner-Bioptic Packet Mode

Packet Mode On must be scanned to set the scanner's format so it is compatible with a bioptic scanner. *Default = Packet Mode Off.*



232PKT0.

* Packet Mode Off



232PKT2.

Packet Mode On

Scanner-Bioptic ACK/NAK Mode

Bioptic ACK/NAK On must be scanned so the scanner will wait for an ACK or NAK from a bioptic scanner after each packet is sent. The Scanner-Bioptic ACK/NAK Timeout (below) controls how long the scanner will wait for a response. *Default = Bioptic ACK/NAK Off.*



232NAK0.

* Bioptic ACK/NAK Off



232NAK1.

Bioptic ACK/NAK On

Scanner-Bioptic ACK/NAK Timeout

This allows you to set the length (in milliseconds) for a timeout for a bioptic scanner's ACK/NAK response. Scan the barcode below, then set the timeout (from 1-30,000 milliseconds) by scanning digits from the [Programming Chart](#), beginning on page 311, then scanning **Save**. *Default = 5100.*



232DLK.

ACK/NAK Timeout

How the Cordless Charge Base/Access Point Works

A CCB01-010BT/CCB01-010BT-BF or a CCB-H-010BT/CCB-H-010BT-BF cordless charge base or an Access Point provides the link between the cordless scanner and the host system. The base/Access Point contains an interface assembly and an RF communication module. The RF communication module performs the data exchange between the cordless scanner and the interface assembly. The control assembly coordinates the central interface activities including: transmitting/receiving commands and data to/from the host system, performing software activities (parameter menuing, visual indicator support, power-on diagnostics), and data translation required for the host system.

The cordless charge base is also a scanner's battery or charge pack charger. Refer to [Battery Recommendations](#), page 47, for additional information.

Link the Scanner to a Charge Base

Turn off power before connecting a base, then power up the computer once the base is fully connected. When the base is connected and powered up, put the scanner in the base to establish a link. The green LED on the base flashes to indicate the scanner is charging.

If the scanner and base have previously been linked, you do not receive any feedback. If this is the first time that the scanner and base are linked, both devices emit a short chirp when their radios link. At this point, that one scanner is linked to one base.

To determine if your scanner has linked to the base correctly, scan one of the sample barcodes beginning on [page 309](#). If the scanner provides a single good read beep and the green LED lights, the scanner has successfully linked to the base. If you receive an error tone and the red LED lights, the scanner has not linked to the base. Refer to [page 295](#) for troubleshooting information.

Link the Scanner to an Access Point

Note: Linking to an Access Point is only supported by Xenon XP 1952 models.

Turn on the computer (laptop/desktop). Plug the interface cable into the Access Point first and then into the appropriate port on the computer. The page button lights up when the connection to the host is made.

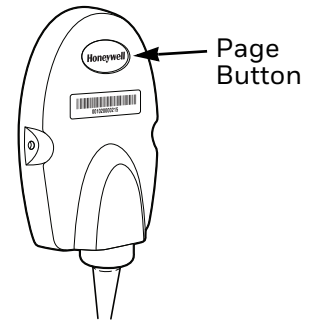

Scan the linking barcode on the top of the Access Point to establish a connection between the Access Point and the scanner. The scanner emits a short beep and flashes the green LED to confirm a connection with the Access Point. The Access Point's page button remains blue.

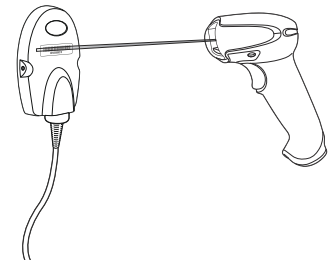

Replace a Linked Scanner

If you need to replace a broken or lost scanner that is linked to a base or an Access Point, scan the **Override Locked Scanner** barcode below with a new scanner and place that scanner in the base, or scan the Access Point linking barcode. The locked link will be overridden, the broken or lost scanner's link with the base or Access Point will be removed, and the new scanner will be linked.



BT_RPL1.

**Override Locked Scanner
(Single Scanner)**

Communication Between the Cordless System and the Host

The cordless scanner provides immediate feedback in the form of a "good read" indication with a green LED on the scanner and an audible beep. The scanner also vibrates, if programmed to do so. This indicates that the barcode has been scanned correctly and the base or Access Point has acknowledged receiving the data. This is possible since the cordless system provides two-way communication between the scanner and the base or Access Point.

When data is scanned, the data is sent to the host system via the base or Access Point. The cordless scanner recognizes data acknowledgment (ACK) from the base or Access Point. If it cannot be determined that the data has been properly sent to the base or Access Point, the scanner issues an error indication. You must then check to see if the scanned data was received by the host system.

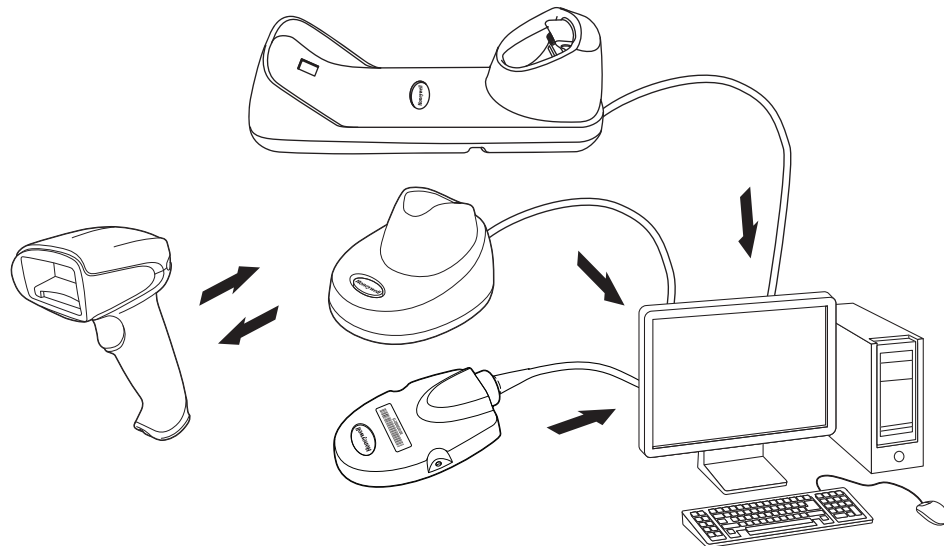

1. Scanner reads code and gets ACK from base or Access Point.
2. Base or Access Point sends data to host.

Program the Scanner and Base or Access Point

When using the scanner and charge base or Access Point together as a system, menu parameters and configuration settings are stored in the charge base or Access Point. Therefore, when programming any menu configuration settings, the scanner must be linked to the intended charge base or Access Point.

Note: This only applies when the scanner is linked to a charge base or Access Point. If the scanner is in a non-base mode, configuration settings are stored in the scanner.

RF (Radio Frequency) Module Operation

The cordless system uses a two-way Bluetooth™ radio to transmit and receive data between the scanner and the base or Access Point. Designed for point-to-point and multi-point-to-single point applications, the radio operates using a license free ISM band, which sends relatively small data packets at a fast data rate over a radio signal with randomly changing frequencies, makes the cordless system highly responsive to a wide variety of data collection applications and resistant to noisy RF environments. The CCB01-010BT/CCB01-010BT-BF and CCB-H-010BT/CCB-H-010BT-BF (Bluetooth Class 1 or Class 2) provide a communication range

of 328 feet (100m) or 33 feet (10m) between the scanner and base or Access Point, depending on the environment. See [Flexible Power Management](#), page 61, for information about controlling this range.

System Conditions

The components of the cordless system interact in specific ways as you associate a scanner to a base or Access Point, as you move a scanner out of range, bring a scanner back in range, or swap scanners between two cordless systems. The following information explains the cordless system operating conditions.

Link Process

Once a scanner is placed into a cordless charge base, the scanner's charge status is checked, and software automatically detects the scanner and links it to the base depending on the selected link mode.

Refer to [Link the Scanner to an Access Point](#), page 42, for information about linking to an Access Point.

Scanner Is Out of Range

The cordless scanner is in communication with its base or Access Point, even when it is not transmitting barcode data. Whenever the scanner can't communicate with the base or Access Point for a few seconds, it is out of range. If the scanner is out of range and you scan a barcode, the scanner issues an error tone indicating no communication with the base or Access Point. A cordless charge base can also sound an alarm. Refer to [Out-of-Range Alarm](#), page 58.

Scanner Is Moved Back Into Range

The scanner relinks if the scanner or the base or Access Point have been reset, or the scanner comes back into range. If the scanner relinks, you will hear a single chirp when the relinking process (uploading of the parameter table) is complete. Refer to [Out-of-Range Alarm](#) on page 58 for further information.

Out of Range and Back into Range with Batch Mode On

The scanner may store a number of symbols (approximately 500 U.P.C. symbols; others may vary) when it is out of range and then send them to the base or Access Point when back in range (see [Batch Mode](#) on page 62).

You will not hear a communication error tone in this mode, but you will hear a short buzz when you press the trigger if the radio communication is not working. Once the radio connection is made, the scanner produces a series of beeps while the data is being transferred to the base or Access Point.

Page Button

When you press the page button on the base or Access Point, the scanners associated with that base or Access Point will begin beeping (3 short and 1 long beep). If you press the trigger on a scanner that is beeping in response, or press the page button on the base or Access Point a second time, all associated scanners will stop beeping. See [Page](#) on page 54 for further information about page button settings.

Note: If you are using a Xenon XP 1950h model, refer to [Quiet Operations - LED and Volume Settings](#) on page 119 for additional Page Button settings.

Page Button and Presentation Modes

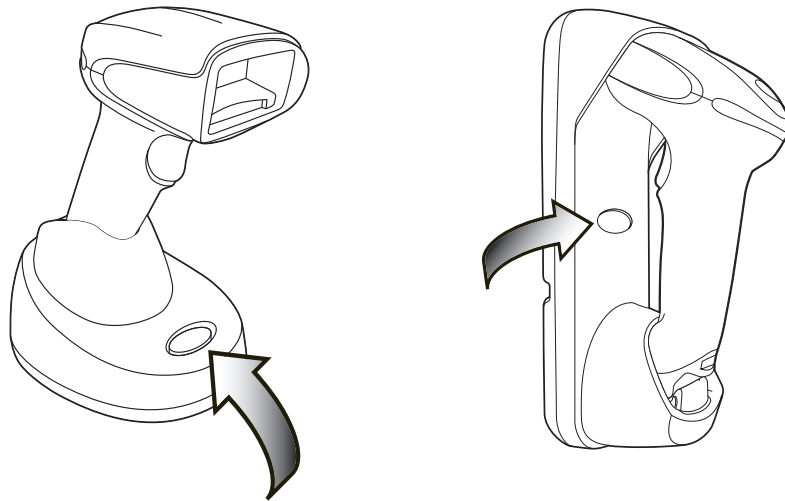

When in Streaming Presentation Mode, the scanner's aimer goes out after a short time, but the scan illumination remains on all the time to continuously search for barcodes (see [Streaming Presentation™ Mode](#) on page 94). When in Temporary Streaming Presentation Mode, pressing the page button on the base puts the scanner into Streaming Presentation Mode until the timeout occurs. If a barcode is scanned before the timeout is reached, the timer starts over.

When the scanner is in the base, press the page button once to put the scanner into Temporary Streaming Presentation Mode. When the scanner is in the base and the base has external power (plugged into an outlet), press the page button twice to put the scanner into Streaming Presentation Mode. Press it twice again to end Streaming Presentation Mode. When the base does not have external power, pressing the page button twice does not trigger Streaming Presentation Mode.

When the scanner is out of the base, the page button works normally. *Default = Temporary Streaming Presentation Mode On.*



*** Temporary Streaming Presentation Mode
On**

To remove Temporary Streaming Presentation Mode, scan the barcode for **Page Mode On** [page 54](#).

Temporary Streaming Presentation Timeout

Set a timeout for the length of time the illumination remains on and searching for barcodes when using Temporary Streaming Presentation Mode. Set the length for the timeout by scanning one of the barcodes below. *Default = 10,000 ms (10 seconds).*



***10 Second Timeout**



30 Second Timeout

Presentation Mode in the Base



*** Disabled**



Enabled

Charge Information

The battery or charge pack is designed to charge while the scanner is positioned in the cordless base unit. Refer to [Scanner Communication and Scanning](#), page 48, for an interpretation of the Charge Status indicators. Refer to [Charge Only Mode](#) (page 56) if you need to charge a scanner without linking it to the base.

Place the scanner in the base that is connected to an appropriate power supply. Use only a Listed Limited Power Source (LPS) or Class 2 type power supply with output rated 5 to 5.2Vdc, 1A.

Note: *If you are powering the base through the interface cable (for example, a USB cable) and not using an external power supply plugged into the aux port, the current available for charging is reduced and charge times are increased.*

Battery Information for the Xenon XP 1952g/1952h

Power is supplied to the Xenon XP 1952g or 1952h scanner by a rechargeable battery that is integrated in the scanner handle. Batteries are shipped only partially charged. The battery should be charged for a minimum of 4 hours before initial use to ensure optimal performance.

Battery Recommendations

- The battery is a lithium ion cell and can be used without a full charge, and can also be charged without fully discharging, without impacting the battery life. There is no need to perform any charge/discharge conditioning on this type of battery.
- Keep the base connected to power when the host is not in use.
- Replace a defective battery immediately since it could damage the scanner.
- Although your battery can be recharged many times, it will eventually be depleted. Replace it after the battery is unable to hold an adequate charge.
- If you are not sure if the battery or charger is working properly, send it to Honeywell International Inc. or an authorized service center for inspection. Refer to [Customer Support](#) on page xvii for additional information.



Caution: Use only Honeywell Li-ion battery packs, model number BAT-SCN05, rated 3.7 Vdc, 7.4Whr in this device. Use of any non-Honeywell battery may result in damage not covered by the warranty.

Safety Precautions for Lithium Batteries

- Do not place batteries in fire or heat the batteries.
- Do not store batteries near fire or other high temperature locations.
- Do not store or carry batteries together with metal objects.
- Do not expose batteries to water or allow the batteries to get wet.
- Do not connect (short) the positive and negative terminals, of the batteries, to each other with any metal object.

- Do not pierce, strike or step on batteries or subject batteries to strong impacts or shocks.
- Do not disassemble or modify batteries.



Caution: Danger of explosion if batteries are incorrectly replaced. Dispose of used batteries according to the recycle program for batteries as directed by the governing agency for the country where the batteries are to be discarded.

Instant Charge Pack Information for the Xenon XP 1952g-BF/Xenon XP 1952h-BF



Caution: A Xenon XP 1952-BF scanner can only be charged by CCB01-010BT-BF or CCB-H-010BT-BF base. Use of any non-Honeywell power supply may result in damage not covered by the warranty.

Power is supplied to the cordless scanner by a rechargeable instant charge pack that is integrated in the scanner handle. The instant charge pack must be charged before initial use. When the scanner is not in use, return it to the base.

Beeper and LED Sequences and Meaning

The scanner contains LEDs on the rear of the unit that indicate linking status, decoding state, and battery condition or instant charge pack condition. The base has LEDs on the top of the unit that indicate its power up, communication, and battery charge condition or instant charge pack condition.

Scanner Communication and Scanning

The following feedback is provided by the scanner and indicates communication and scanning status.

LED	Beeper	Cause
Normal Operation		
Green Flash	1 Beep	Successful communication or linking
Red, Blinking	Razz or Error Tone	Failed communication
Menu Operation		
Green Flash	2 Beeps	Successful menu change
Red, Blinking	Razz or Error Tone	Unsuccessful menu change

Scanner Charge Pack Status

The following charge status feedback is provided by the scanner when the scanner is out of the base and has been idle for 5 seconds.

Scanner LED	Scanner Beep	Charge Level
Yellow, 3 sets of flashes repeated every 3 seconds	No beep	less than 15%
Red, 3 sets of flashes repeated every 3 seconds	No beep	less than 5%
Red, 20 sets of rapid flashes	No beep	less than 2%

When the scanner is out of the base, you can manually initiate a charge level query by pressing the scanner trigger 3-times in rapid succession (approx. 2 seconds). The scanner provides the following feedback when a query is initiated.

Scanner LED	Scanner Beep	Charge Level
Red, 3 sets of quick flashes in a row	No beep	less than 15%
Yellow, 3 sets of quick flashes in a row	No beep	less than 5%
Green, 3 sets of quick flashes in a row	No beep	less than 2%

The following charge status feedback is provided by the scanner while the scanner resides in the base.

Scanner LED	Scanner Beep	Charge Level
Red, 2 sets of flashes every 10 seconds	No beep	less than 20%
Yellow, 2 sets of flashes every 10 seconds	No beep	20% ~ 40%
Green, 2 sets of flashes every 10 seconds	No beep	greater than 40%
Green, steady on	No beep	100%

Base/Access Point Communication and Scanning

The following feedback is provided by the base (red LED) or Access Point (blue LED) and indicates communication and scanning status.

LED	Communication Condition
Off	USB suspend
On continuously	Power on, system idle
Short blinks in multiple pulses. Occurs while transferring data to/from the RF module or the Host port.	Receiving data

Base Power Communication Indicator

To display the power indicator on a base or an Access Point, scan the **Base Power Communication Indicator On** barcode. To turn off the power indicator, scan the **Off** barcode. *Default = On.*



BASRED1.

* Base Power Communication Indicator On



BASRED0.

Base Power Communication Indicator Off

Base Charge Status

When charging the base indicates the progress while the scanner resides in the base.

LED	Charge Level	Approximate Expected Scans (see note)
Green On	100%	450
Green Slow Blink	50-99%	200
Green Fast Blink	30-50%	100
Yellow Fast Blink	0-30%	Charging, do not scan

Note: *The number of scans was measured with a clearly printed UPC code in good light. The approximate number of scans varies with changes in label quality, Symbology, and environmental factors.*

Low Power Alerts

Note: *Low Power Alerts are only supported by battery-free scanners Xenon XP 1952g-BF and Xenon XP 1952h-BF.*

Low power alerts allow you to customize battery-free scanner LEDs to flash in different patterns when the charge level is low. Use the barcodes that follow to customize the settings for the power range being configured, the number of flashes per alert, the interval between flashes, the number of alerts, and the interval between alerts. The beeper can also be set to silent, or to sound with the flash patterns.

Low Power Alert Range

Set the power range that will trigger a low power alert. *Default = 10-30%.*



***Low Power Alert 10-30%**



Low Power Alert 10-50%

Low Power Alert Flash Number

You can program the battery-free scanner's LEDs to flash up to 9 times for the low power alert. If the [Low Power Alert Bleep](#) (page 52) is on, a double bleep will sound with each flash. To set the number of low power flashes, scan the barcode below and then scan a digit (1-9) barcode from the [Programming Chart](#), beginning on page 311, then **Save**. *Default = 3 flashes.*



Low Power Alert Flash Number

Interval Between Flashes

Set the length of time, in seconds, between the LED flashes for a low power alert. To set the interval, scan the barcode below and then scan a digit (1-9) barcode from the [Programming Chart](#), beginning on page 311, then **Save**. *Default = 2 seconds between flashes.*



Interval Between Flashes

Low Power Alert Repeat

Set how many times you want the low power flash pattern (flashes and intervals) to repeat. To set the number, scan the barcode below and then scan a digit (1-5) barcode from the [Programming Chart](#), beginning on page 311, then **Save**. *Default = 1.*



Low Power Alert Repeat

Interval Between Alerts

If you have set the [Low Power Alert Repeat](#) (page 51) to more than 1, you can set the length of time, in seconds, between the low power alerts. To set this interval, scan the barcode below and then scan a digit (10-120) barcode from the [Programming Chart](#), beginning on page 311, then **Save**. *Default = 10 seconds between alerts.*



LPI_DL.

Interval Between Alerts

Low Power Alert Beep

If you do not want the beeper to sound for a low power alert, scan the **Low Power Alert Beep Off** barcode. Any low power alert settings will still flash the scanner LEDs, whether or not the beeper sounds. *Default = Low Power Alert Beep On.*



LPIBEP0.

Low Power Alert Beep Off



LPIBEP1.

***Low Power Alert Beep On**

Reset Scanner

Scanning this barcode reboots the scanner and causes it to relink with the base or Access Point.



RESET_.

Reset Scanner

Scan While in Base Cradle

If you want to be able to scan barcodes while the scanner is in the base cradle, scan the **Scan in Cradle On** barcode below. If you want to only allow scanning when the scanner is out of the base cradle, scan **Scan in Cradle Off**. If you want the scanner

to shut down when in the base cradle, scan **Shut Down Scanner in Cradle**. Default for CCB01-010BT = Scan in Cradle On. Default for CCB-H-010BT = Scan in Cradle Off.



BT_SIC0.
Scan in Cradle Off



BT_SIC1.
Scan in Cradle On



BT_SIC2.
Shut Down Scanner in Cradle

Base Charge Modes

When the base has both an external power supply (plugged into the auxiliary power port) and a host interface cable, it will draw its power from the external power supply. When the base does not have an external power supply, it draws its power from the interface cable. However, the scanner charges more slowly from a host interface cable than if auxiliary power were available. Using the following selections, you can specify whether the scanner is charged from power supplied via the host interface cable.

When **Base Charge Off** is selected, the scanner does not charge when the scanner is in the base cradle.

When **External or Interface Cable Power** is selected, the scanner charges from the base's external power supply, if there is one. If there is no external power supply to the base, the scanner charges from the interface cable.

When **External Power Only** is selected, the scanner only charges from the base's external power supply. If there is no external power supply, the scanner does not charge.

Note: If you are using a cordless charge base in [Presentation Mode](#), **External Power Only** is the only setting available.

Default = External or Interface Cable Power.



BTRCHG0.
Base Charge Off



BTRCHG1.

* External or Interface
Cable Power



BTRCHG2.

External Power Only

Page

Page Mode

By default, the page button on the base or Access Point pages the scanners associated with that base or Access Point. If you want the page button on your base or Access Point to be disabled, scan the **Page Mode Off** barcode, below. When Page Mode is off, the base or Access Point will no longer page scanners when the button is pressed. The red LED on the base or blue LED on the Access Point will remain lit to indicate that page mode is off. (This light will go out when the button is pressed, then back on when it's released.) *Default = Page Mode On.*

Note: *If you are using a Xenon XP 1952h model, refer to [Quiet Operations - LED and Volume Settings](#) on page 119 for additional Page Button settings.*



BEPPGE1.

* Page Mode On



BEPPGE0.

Page Mode Off

Page Pitch

When you press the page button on the base or Access Point, the scanners associated with that base or Access Point will begin beeping (see [Page Button](#) on page 45). You can set the pitch of the paging beep for each scanner by scanning one of the following barcodes. *Default = Low.*



BEPPFQ1000.

* Low (1000 Hz)



BEPPFQ3250.
Medium (3250 Hz)



BEPPFQ4200.
High (4200 Hz)

Error Indicators

Beeper Pitch - Base Error

The base can be configured to beep at a particular pitch when an error occurs, such as transmission problems to a host system. The beeper pitch codes modify the pitch (frequency) of the error tone the base emits when there is an error. *Default = Low.*



BASFQ2250.
* Low/Razz (250 Hz)



BASFQ23250.
Medium (3250 Hz)



BASFQ24200.
High (4200 Hz)

Number of Beeps - Base Error

The number of beeps and LED flashes emitted by the base for an error condition can be programmed from 1 - 9. For example, if you program this option to have five error beeps, there will be five error beeps and five LED flashes in response to an error. To change the number of error beeps, scan the barcode below and then scan a digit (1-9) from the [Programming Chart](#), beginning on page 311, then **Save**. *Default = 1.*



BASERR.
Number of Base Error Beeps/LED Flashes

Scanner Report

Scan the barcode below to generate a report for the connected scanners. The report indicates the port, work group, scanner name, and address. To assign a name to your scanner, refer to [Menu Command Syntax](#), page 239.



RPTSCN.

Scanner Report

Scanner Address

Scan the barcode below to determine the address of the scanner you are using.



BT_LDA.

Scanner Address

Base or Access Point Address

Scan the barcode below to determine the address of the base or Access Point you are using.



BASLDA.

Base Address

Scanner Modes

Your scanner is capable of working in single scanner mode, multiple scanner mode, or with Bluetooth devices other than the charge base or Access Point.

Charge Only Mode

There may be times when you want to charge your scanner, but not link to the base. For example, if a scanner is linked to an Access Point or other Bluetooth device and you need to charge the scanner, but want to retain your existing link.

In order to program the base for Charge Only Mode, you must link a scanner to it. Once the scanner is linked to the base, scan the **Charge Only Mode** barcode. Any subsequent scanners placed in that base will charge without linking to it. The scanner used to program the base remains linked to the base. To unlink this scanner, scan [Unlink Scanner](#) on page 58.



Note: When in Charge Only Mode, the scanner periodically wakes up and beeps. See [Power Up Beeper](#) on page 81 to change this setting.

Charge and Link Mode

If you want to charge a scanner and link to the base, use Charge and Link Mode. If the base is programmed for Charge Only Mode, you must link a scanner to it first in order to program it for Charge and Link Mode. Scan the linking barcode on the base to link the scanner, then scan **Charge and Link Mode**. *Default = Charge and Link Mode.*



Linked Modes

Locked Link Mode and Open Link Mode are the link modes that accommodate different applications. Scan the appropriate barcodes included in the Open Link and Locked Link Mode explanations that follow to switch from one mode to another. *Default = Open Link Mode.*

Locked Link Mode - Single Scanner

If you link a scanner to a base or an Access Point using the Locked Link Mode, other scanners are blocked from being linked if they are inadvertently placed into the base, or if the Access Point linking barcode is scanned. If you do place a different scanner into a base, it will charge the scanner, but the scanner will not be linked.



To use a different scanner, you need to unlink the original scanner by scanning the **Unlink Scanner** barcode. (See [Unlink the Scanner](#), page 58.)

Open Link Mode - Single Scanner

When newly shipped or defaulted to factory settings, a scanner is not linked to a base or an Access Point. A link is established when the scanner is placed into a base, or an Access Point linking barcode is scanned. When in Open Link Mode, a new link is established when a new scanner is placed in the base, or you scan an Access Point linking barcode. Each time a scanner is placed into a base or scans an Access Point linking barcode, the scanner becomes linked to the base or Access point and the old scanner is unlinked.



BASCON1,DNG1.

* Open Link Mode
(Single Scanner)

Unlink the Scanner

If a base or an Access Point has a scanner linked to it, that scanner must be unlinked before a new scanner can be linked. Once the previous scanner is unlinked, it will no longer communicate with the base or Access Point. To unlink the scanner from a base or an Access Point, scan the **Unlink Scanner** barcode below.



BT_RMV.

Unlink Scanner

Override Locked Scanner

If you need to replace a broken or lost scanner that is linked to a base or an Access Point, scan the **Override Locked Scanner** barcode below with a new scanner and place that scanner in the base, or scan the Access Point linking barcode. The locked link will be overridden; the broken or lost scanner's link with the base or Access Point will be removed, and the new scanner will be linked.



BT_RPL1.

Override Locked Scanner
(Single Scanner)

Out-of-Range Alarm

If your scanner is out range of the base, an alarm sounds from both your base and scanner. If your scanner is out range of an Access Point, an alarm sounds from just the scanner. The alarm stops when the scanner is moved closer to the base or Access Point, when the base or Access Point connects to another scanner, or when the alarm duration expires. To activate the alarm options for the scanner or the

base and to set the alarm duration, scan the appropriate barcode below and then set the time-out duration (from 0-3000 seconds) by scanning digits on the [Programming Chart](#), beginning on page 311, then **Save**. *Default = 0 sec (no alarm)*.



BASORD.

Base Alarm Duration

Note: *The Access Point does not have a base alarm.*



BT_ORD.

Scanner Alarm Duration

Note: *If you are out of range when you scan a barcode, you will receive an error tone even if you do not have the alarm set. You receive the error tone because the data could not be sent to the base or Access Point or the host.*

Alarm Sound Type

You may change the alarm type for the scanner or base by scanning the appropriate barcode below and then scanning a digit (0-7) barcode from the [Programming Chart](#), beginning on page 311, then **Save**. *Default = 0.*

The sounds are as follows:

Setting	Sound
0	3 long beeps, medium pitch
1	3 long beeps, high pitch
2	4 short beeps, medium pitch
3	4 short beeps, high pitch
4	single chirps, medium pitch
5	2 chirps, then 1 chirp, medium pitch
6	single chirps, high pitch
7	2 chirps, then 1 chirp, high pitch



BASORW.

Base Alarm Type



BT_ORW.

Scanner Alarm Type

Scanner Power Time-Out Timer

When there is no activity within a specified time period, the scanner enters low power mode. Scan the appropriate scanner power time-out barcode to change the time-out duration (in seconds).

Note: Scanning zero (0) is the equivalent of setting no time-out.

If there are no trigger pulls during the timer interval, the scanner goes into power down mode. Whenever the trigger is enabled, the timer is reset. The scanner will not go into power down mode when it is in the base and charging. *Default = 3600 seconds.*



Note: When the scanner is in power down mode, press the trigger to power the unit back up. There will be a set of power up beeps and a delay of up to a few seconds for the radio to join. The scanner will then be ready to use.

Flexible Power Management

If you are experiencing network performance issues, and suspect the scanner is interfering with other devices, you can turn down the power output of the scanner. This reduces the range between the scanner and a base or an Access Point as shown in the following illustration:

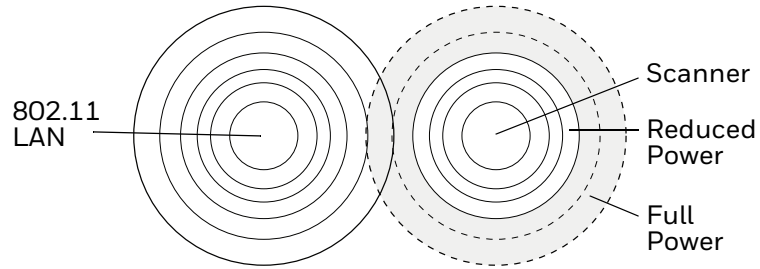

Xenon XP 1952g/1952h

Scan one of the barcodes below to set the scanner's power output to **Full Power** (100%), **Medium Power** (35%), **Medium Low Power** (5%), or **Low Power** (1%).
Default = Full Power.

For Bluetooth Class 1 operation, use Full Power.

For Bluetooth Class 2 operation, use Medium Power or lower.

For BLE operation, use Medium Power.



BT_TXP100.
* Full Power



BT_TXP35.
Medium Power



BT_TXP5.
Medium Low Power



BT_TXP1.
Low Power

Xenon XP 1952g-BF/1952h-BF

Scan one of the barcodes below to set the scanner's power output to **Full Power** (100%), **Medium High Power** (87%), **Medium Power** (50%), or **Low Power** (1%).
Default = Full Power.



BT_TXP8.
* Full Power



BT_TXP7.
Medium High Power



BT_TXP4.
Medium Power



BT_TXP1.
Low Power

Batch Mode

Batch mode is used to store barcode data when a scanner is out of range of its base or Access Point, or when performing inventory. The data is transmitted to the base or Access Point once the scanner is back in range or when the records are manually transmitted.

Note: *Batch Mode is only supported by the Honeywell Charge and Communication Base (CCB) and Honeywell Access Point (AP). Batch mode has limitations when using multiple scanners to one base or Access Point. If a cordless system is being used in "multiple link mode," where up to 3 scanners are to be connected to one base or Access Point, some accumulated or batched scans could be lost if scanners are constantly being moved in and out of range.*

Automatic Batch Mode stores barcode data when the scanner is out of range of the base or Access Point. The data is automatically transmitted to the base or Access Point once the scanner is back in range. When the scanner's buffer space is full, any barcodes scanned generate an error tone. In order to scan barcodes again, the scanner must be moved back into range of the base or Access Point so data can be transmitted.

Inventory Batch Mode stores barcode data, whether or not you are in range of the base or Access Point. To transmit the stored data to the base or Access Point, either place the scanner in the base, or scan [Transmit Inventory Records](#) (page 67). When

the scanner's buffer space is full, any barcodes scanned generate an error tone. In order to scan barcodes again, the data must be transmitted to the base or Access Point. Once the data is transmitted, it is cleared in the scanner.

Persistent Batch Mode is the same as Inventory Batch Mode, except that once the data is transmitted to the base or Access Point, it is retained in the scanner. If you want to transmit more than once, you can do so using this mode. In order to clear the scanner's buffer, you must scan [Clear All Codes](#) (see page 67).

Default = Batch Mode Off.



BATENA0.

* Batch Mode Off



BATENA1.

Automatic Batch Mode



BATENA2.

Inventory Batch Mode



BATENA3.

Persistent Batch Mode

Batch Mode Beep

When scanning in [Inventory Batch Mode](#) (page 63), the scanner beeps every time a barcode is scanned. When Batch Mode Beep is **On**, you will also hear a click when each barcode is sent to the host. If you do not want to hear these clicks, scan **Batch Mode Beep Off**. *Default = Batch Mode Beep On.*



BATBEP0.

Batch Mode Beep Off



BATBEP1.

* Batch Mode Beep On

Batch Mode Storage

When a scanner is storing data during a Batch Mode process, you can select whether the data is stored in Flash memory or in RAM.

Flash Storage: The scanner writes any untransmitted data to flash memory prior to powering down. The data will still be there when the scanner powers back up. However, the scanner will power down, even with untransmitted data, if it reaches a power down timeout or if the battery or charge pack power is very low.

RAM Storage: The scanner will not power down while it contains data that has not been transmitted to the base or Access Point, even if it reaches a power down timeout. However, if the scanner runs out of power, it will power down and the data will be lost.

Default = Flash Storage.



BATNVS1.

* Flash Storage



BATNVS0.

RAM Storage

Batch Mode Quantity

When in Batch Mode, you may wish to transmit the number of multiple barcodes scanned, rather than a single barcode multiple times. For example, if you scan three barcodes called XYZ with **Batch Mode Quantity Off**, when you transmit your data it will appear as XYZ three times. Using **Batch Mode Quantity On** and the Quantity Codes ([page 66](#)), you could output your data as “XYZ, 00003” instead.

Note: *If you wish to format your output, for example, place a CR or tab between the barcode data and the quantity, refer to [Data Format](#) beginning on page 131.*

Default = Batch Mode Quantity Off.



BATQTY0.

* Batch Mode Quantity Off



BATQTY1.

Batch Mode Quantity On

Enter Quantities

Quantity Codes ([page 66](#)) allow you to enter a quantity for the last item scanned, up to 9999 (default = 1). Quantity digits are shifted from right to left, so if a fifth digit is scanned, the first digit scanned is discarded and the second, third and fourth digits are moved to the left to accommodate the new digit.

For example, if the Quantity 5 barcode is scanned after the quantity has been set to 1234, then the 1 is dropped, the quantity will be 2345.

Example: Add a quantity of 5 for the last item scanned.

1. Scan the item's barcode.
2. Scan the quantity **5** barcode.

Example: Add a quantity of 1,500 for the last item scanned.

1. Scan the item's barcode.
2. Scan the quantity **1** barcode.
3. Scan the quantity **5** barcode.
4. Scan the quantity **0** barcode.
5. Scan the quantity **0** barcode.

Example: Change a quantity of 103 to 10.

To correct an incorrect quantity, scan the quantity 0 barcode to replace the incorrect digits, then scan the correct quantity barcodes.

1. Scan the quantity **0** barcode to change the quantity to 1030.
2. Scan the quantity **0** barcode to change the quantity to 0300.
3. Scan the quantity **1** barcode to change the quantity to 3001.
4. Scan the quantity **0** barcode to change the quantity to 0010.

Default = 1.

Quantity Codes

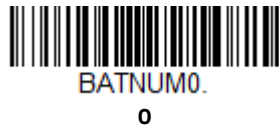

Quantity Codes (Continued)



BATNUM4.

4



BATNUM6.

6



BATNUM8.

8



BATNUM5.

5



BATNUM7.

7



BATNUM9.

9

Batch Mode Output Order

When batch data is transmitted, select whether you want that data sent as **FIFO** (first-in first-out), or **LIFO** (last-in first-out). *Default = Batch Mode FIFO.*



BATLIF0.

* Batch Mode FIFO



BATLIF1.

Batch Mode LIFO

Total Records

If you wish to output the total number of barcodes scanned when in Batch Mode, scan **Total Records**.



BATNRC.

Total Records

Delete Last Code

If you want to delete the last barcode scanned when in Batch Mode, scan **Delete Last Code**.



Clear All Codes

If you want to clear the scanner's buffer of all data accumulated in Batch Mode, scan **Clear All Codes**.



Transmit Records to Host

If you are operating in Inventory Batch Mode (see [Inventory Batch Mode](#) on page 63), you must scan the following barcode to transmit all the stored data to the host system.



Batch Mode Transmit Delay

Sometimes when accumulated scans are sent to the host system, the transmission of those scans is too fast for the application to process. To program a transmit delay between accumulated scans, scan one of the following delays. *Default = Off.*

Note: *In most cases, a short (250 ms (milliseconds)) delay is ideal, however, longer delays may be programmed. Contact Technical Support ([page xvii](#)) for additional information.*





Multiple Scanner Operation

Note: *Multiple Scanner Operation Mode allows you to link up to 3 scanners to one base or Access Point. You cannot join a 4th scanner until you unlink one of the 3 scanners or take a scanner out of range.*

Note: *A base can only have one Xenon XP 1952-BF scanner linked to it.*

To put the scanner in multiple scanner mode, scan the barcode below. Once you scan this barcode, the scanner is unlinked from the base or Access Point and must either be placed into the base, or you must scan the Access Point linking barcode in order to relink.



Scanner Name

You may assign a name to each scanner you are using for identification purposes. For example, you may want to have a unique identifier for a scanner that is receiving imaging commands sent from the base or Access Point.

The default name is in the format “ScannerName_Model_SN_XXXXXXXXXX” If you have more than one scanner linked to a base, and they all have the same name, the first scanner linked to the base receives commands. When renaming a series of scanners with identical names, unlink all except one of the scanners from the base.

Perform the rename operation using either the barcodes on [page 69](#), or by sending the serial command **:ScannerName:BT_NAMNewName**. where *ScannerName* is the current name of the scanner, and *NewName* is the new name for the scanner. If you wish to change the names of additional scanners, link them one at a time and repeat the **:ScannerName:BT_NAMNewName**. command for each scanner.

To rename scanners with sequential numeric names, scan the barcodes below. Scan the **Reset** code after each name change and wait for the scanner to relink to the base or Access Point before scanning a barcode to rename the next scanner.



You may also scan the **Scanner Name** barcode below and scan a number for the scanner name. For example, if you wanted to name the linked scanner “312,” you would scan the barcode below, scan the **3**, **1**, and **2** barcodes on the [Programming Chart](#), beginning on page 311, then **Save**. Scan the **Reset** barcode and wait for the scanner to relink to the base.

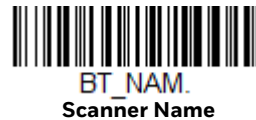

Application Work Groups

Note: A base can only have one Xenon XP 1952-BF scanner linked to it.

Your cordless system can have up to 3 scanners linked to one base or Access Point. You can also have up to 3 work groups. If you want to have all of the scanners’ settings programmed alike, you don’t need to use more than one work group. If you want each scanner to have unique settings (e.g., beeper volume, prefix/suffix, data formatter), then you may program each scanner to its own unique work group and may program each scanner independently. For example, you might want to have multiple work groups in a retail/warehouse application where you need to have different data appended to barcodes used in the warehouse area versus the retail area. You could assign all the scanners in the retail area to one work group and those in the warehouse to another. Consequently, any desired changes to either the retail or warehouse area would apply to all scanners in that particular work group. Honeywell’s online configuration tool, EZConfig-Scanning ([page 236](#)), makes it easy for you to program your system for use with multiple scanners and multiple work groups.

The scanner keeps a copy of the menu settings it is using. Whenever the scanner is connected or reconnected to a base or an Access Point, the scanner is updated with the latest settings from the base or Access Point for its work group. The scanner also receives menu setting changes processed by the base or Access Point. If a scanner is removed from a base or an Access Point and placed into another base or linked to another Access Point, it will be updated with the new base/Access Point settings for whatever work group to which that the scanner was previously assigned. For example, if the scanner was in work group 1 linked to the first base, it will be placed in work group 1 in the second base with the associated settings.

Application Work Group Selection

This programming selection allows you to assign a scanner to a work group by scanning the barcode below. You may then program the settings (e.g., beeper volume, prefix/suffix, data formatter) that your application requires. *Default = Group 0.*



Reset the Factory Defaults: All Application Work Groups

The following barcode defaults all of the work groups to the factory default settings.



To see what the factory default settings are, refer to the table of [Menu Commands](#), beginning on page 244. The standard product default settings for each of the commands are indicated by an asterisk (*).

Note: Scanning this barcode also causes both the scanner and the base or Access Point to perform a reset and become unlinked. The scanner must be placed in the base, or the Access Point linking barcode must be scanned to re-establish the link. Refer to [Scanner Modes](#), page 56 for additional information.

If your scanner is in multiple scanner mode, you will hear up to 30 seconds of beeping while all scanners are relinked to the base or Access Point and the settings are changed.

Reset the Custom Defaults: All Application Work Groups

If you want the custom default settings restored to all of the work groups, scan the **Custom Product Default Settings** barcode below. (If there are no custom defaults, it will reset the work groups to the factory defaults.) See [Set Custom Defaults](#) on page 13 for further information about custom defaults.



Note: Scanning this barcode also causes both the scanner and the base or Access Point to perform a reset and become unlinked. The scanner must be placed in its base, or the Access Point linking barcode must be scanned to re-establish the link. Refer to [Scanner Modes](#), page 56 for additional information.

If your scanner is in multiple scanner mode, you will hear up to 30 seconds of beeping while all scanners are relinked to the base or Access Point and the settings are changed.

Use the Scanner with Bluetooth Devices

The scanner can be used either with the charge base, an Access Point, or with other Bluetooth devices. Those devices include personal computers, laptops, PDAs, and Honeywell mobility systems devices.

Bluetooth Secure Simple Pairing (SSP)

Secure Simple Pairing (SSP) allows you to connect simply and securely to other Bluetooth devices without having to enter a PIN code (as described in [Bluetooth HID Keyboard Connect](#) procedure). SSP is only available when using Bluetooth

version 2.1 or higher. When SSP is on, no PIN is required for pairing. Turn SSP off if you are connecting to a Bluetooth device that is not using a compatible Bluetooth version. *Default = Bluetooth SSP On.*



Bluetooth HID Keyboard Connect

Your scanner can be paired with Bluetooth-capable devices, such as personal computers, laptops, and tablets, so that scanned data appears on your device screen as though it was entered on the keyboard. In order to pair with the Bluetooth device:

1. Scan the appropriate **Bluetooth HID Keyboard Connect** barcode below.



2. Set your personal computer, laptop or tablet so it searches for other Bluetooth devices. (Refer to your device's User Guide for pairing instructions.)
3. Select the scanner name on your device. Some devices will automatically pair with the scanner. If your device pairs automatically with the scanner, it displays a successful pairing message and you do not need to continue to the next step.
4. If your device does not automatically pair with the scanner, a PIN is displayed. This PIN must be scanned within 60 seconds. Quickly scan **Bluetooth PIN Code** below, then scan the numeric barcode(s) for the PIN code from the chart below, then scan **Save**.





Virtual Keyboard

Once your scanner has been connected directly to an iPad, smart phone, or laptop, you can toggle the virtual keyboard on your device with a quick double pull of the scanner trigger.

Bluetooth HID Keyboard Disconnect

If your scanner has been connected directly to an iPad, smart phone, or laptop, you must disconnect it in order to once again communicate with the base or Access Point. Scan the **Bluetooth HID Keyboard Disconnect** barcode to unlink the scanner from the currently linked host. Scan the linking barcode on the base or Access Point to relink the scanner.



Bluetooth HID Keyboard Disconnect

Pair with Bluetooth Low Energy (BLE) Devices

Use the following codes to connect to Bluetooth low energy devices. Scan **HID BLE Connect** to connect the scanner to Bluetooth Low Energy HID devices. Scan **Serial BLE Connect** to establish two-way communication between the scanner and Bluetooth Low Energy serial devices.



HID BLE Connect



Serial BLE Connect

Bluetooth Serial Port - PCs/Laptops

Scanning the **Non-Base BT Connection** barcode below unlinks your scanner and puts it into a discoverable state. Once the scanner searches for and connects with a Bluetooth host, the scanner stores the connection to the host device address and switches virtual COM ports. This allows the scanner to automatically relink to the host if the connection is lost.



Non-Base BT Connection

PDA/Mobility Systems Devices

You may also use the scanner with a PDA or a Honeywell Mobility Systems device. Scan the barcode below and follow the instructions supplied with your Bluetooth device to locate the scanner, and connect with it.



BT Connection - PDA/Mobility Systems Device

Change the Scanner's Bluetooth PIN Code

Some devices require a PIN code as part of the Bluetooth security features. Your scanner's default PIN is **1234**, which you may need to enter the first time you connect to your PDA or PC. The PIN code must be between 1 and 16 characters. To change the PIN, scan the barcode below and then scan the appropriate numeric barcodes from the [Programming Chart](#), beginning on page 311, then **Save**.



Bluetooth PIN

Minimize Bluetooth/ISM Band Network Activity

The settings described below can help you customize the relinking behavior of the cordless area-imaging system to obtain the best compromise between convenience and low interference.

Note: ISM band refers to the 2.4 to 2.48 GHz frequency band used by wireless networks, cordless phones, and Bluetooth.

Auto Reconnect Mode

Auto Reconnect controls whether or not the scanner automatically begins the relink process when a loss of connection is detected. When the **Auto Reconnect On** barcode is scanned, the scanner begins the relink process immediately, without user intervention. *Default = Auto Reconnect On.*



* Auto Reconnect On



Auto Reconnect Off

The table below shows the results of the Auto Reconnect On and Off settings:

Event	Auto Reconnect On	Auto Reconnect Off
Scanner out of range	Relink occurs automatically. If maximum number of link attempts is unsuccessful, then the scanner must be relinked by either pulling the trigger, placing the scanner in the base, or scanning the Access Point linking barcode. (See Maximum Link Attempts on page 76.)	The scanner is relinked by pulling the trigger, or scanning the Access Point linking barcode.
Base or Access point reset (firmware upgrade or power cycle)	Scanner behaves as if out of range.	No attempt to relink made while base or Access Point is powered off. Trigger must be pulled to initiate relinking.
Scanner power down due to Power Time-Out Timer setting	Trigger must be pulled, Access Point linking barcode must be scanned, or the scanner must be placed in the base unit to relink. (Note: Scanner relinks on power up, but powers on due to one of the above actions.)	
Scanner reset due to firmware upgrade	Relink occurs automatically.	
Scanner reset due to battery or charge pack change	Relink occurs automatically.	
Scanner placed in different base unit	Relink to new base occurs automatically.	

Maximum Link Attempts

The Maximum Link Attempts setting controls the number of times the scanner tries to form a connection with a base or an Access Point. During the connection setup process, the scanner transmits in order to search for and connect to a base or an Access Point. In order to prevent continuous transmissions that could interfere with other users of the ISM band, the number of attempts to connect is limited by this setting. After the maximum number of attempts is reached, the scanner will not attempt to reconnect to a base or an Access Point. Pressing the trigger, scanning an Access Point linking barcode, or placing the scanner in the cradle resets the attempt count and the scanner will again try to link.

Scan the **Maximum Link Attempts** barcode, then scan the number of attempts for the setting (from 0-100) from the [Programming Chart](#), beginning on page 311, then **Save**. *Default = 0.*



Note: *When Auto Reconnect Mode is On, setting Maximum Link Attempts to zero will cause the scanner to try to link until the Power Time-Out Timer setting expires. When Auto Reconnect Mode is Off, setting Maximum Link Attempts to zero will cause the scanner to only attempt linking one time after a trigger press.*

Relink Time-Out

Relink Time-Out controls the idle time between relink attempts. An attempt to link a scanner to a base or an Access Point typically lasts up to 5 seconds. This is the time when the scanner is actually attempting a contact. Relink Time-Out controls the amount of time, in seconds, that elapses between the end of one connection attempt and the start of the next.

Note: *The length of time for an attempt depends on the number of scanners connected to a base unit or Access Point. An extra 7 seconds may be required when a connection is successful.*

Scan the **Relink Time-Out** barcode, then scan the number of seconds for the setting (from 1-100) from the [Programming Chart](#), beginning on page 311, then **Save**. *Default = 3 seconds.*



Bluetooth/ISM Network Activity Examples

Default values

When the scanner goes out of range, the scanner repeatedly attempts to connect to the base unit or Access Point. Each attempt consists of approximately 5 seconds of active time followed by 3 seconds of idle time. After one hour, the scanner powers off and batch mode data is lost.

Example: Maximum Link Attempts set to 15
Other values at default setting

When the scanner goes out of range, 15 attempts are made to link to the base unit or Access Point. Each attempt consists of approximately 5 seconds of active time followed by 3 seconds of idle time. After 15 cycles ($8 \times 15 = 120$), or about 2 minutes, the scanner stops trying to connect to the base or Access Point, but retains any barcodes that may have been saved in batch mode. After one hour, the scanner powers off and batch mode data is lost.

Example: Auto Reconnect Mode set to 0
Maximum Link Attempts set to 15
Other values at default setting

When the scanner goes out of range, no action is taken to relink. When the trigger is pulled, 15 attempts are made to link to the base or Access Point. Each attempt consists of approximately 5 seconds of active time followed by 3 seconds of idle time. After 15 cycles ($8 \times 15 = 120$), or about 2 minutes, the scanner stops trying to connect to the base or Access Point, but retains any barcodes that may have been

saved in batch mode. After one hour, the scanner powers off and batch mode data is lost. Refer to [Auto Reconnect Mode](#), page 75, to review other events that can start the relink process.

Example: Auto Reconnect Mode set to 1
Maximum Link Attempts set to 0
Relink Time-Out set to 10
Scanner Power Time-Out Timer set to 1800

Note: See [Scanner Power Time-Out Timer](#) on page 60.

The scanner attempts to connect to the base or Access Point every 15 seconds, measured from one attempt start to the next attempt start. After one half hour, the scanner powers off.

Host Acknowledgment

Some applications require that the host terminal (or server) validate incoming barcode data (database look-up) and provide acknowledgment to the scanner whether or not to proceed. In Host ACK Mode, the scanner waits for this acknowledgment after each scan. Visual and audible acknowledgments provide valuable feedback to the scan operator. The Host ACK functionality is controlled via a number of pre-defined escape commands that are sent to the scanner to make it behave in different ways.

Note: *System performance degrades when using Host ACK at rates lower than 9600 baud.*

The following criteria must be met for the Host ACK to work correctly:

- The cordless system must be configured for Host Port RS232 (terminal ID = 000) or USB COM Emulation (terminal ID = 130).
- RTS/CTS is defaulted off. You must enable it if the host system requires it.
- Host ACK must be set to **On** ([page 79](#)).
- A comma must be used as a terminator.
- The host terminal software must be capable of interpreting the barcode data, make decisions based on the data content, and send out appropriate escape commands to the scanner.

Escape commands are addressed to the scanner via “Application Work Groups.” Once a command is sent, all scanners in a group respond to that command. Because of this, it is recommended that each scanner is assigned to its own group in Host ACK mode.

The commands to which the scanner responds are listed on [page 80](#). The **[ESC]** is a **1B** in hex. A typical command string is **y [ESC] x**, where “y” is the application work group number, “[ESC] x” is the escape command, and the comma is the terminator, which is required. (When “y” is not specified, the command is sent to the default Application Work Group 0.)

Example: Commands may be strung together to create custom response sequences. An example of a command string is listed below.

[ESC]4,[ESC]5,[ESC]6,

The above example will make a scanner that is in application work group zero beep low, then medium, then high.

Example: A good read beep is required for any item on file, but a razz or error tone is required if the item is not on file. In this case,

[ESC]7, is sent from the host to the scanner for an on-file product

[ESC]8,[ESC]8, is sent from the host to the scanner for a not-on-file product

When a barcode is scanned, the scanner enters a timeout period until either the host ACK sequence is received, or the timeout expires (in 10 seconds, by default).

Once Host ACK is enabled, the system works as follows when a barcode is scanned:

- The scanner reads the code and sends data to the base or Access Point to transmit to the host system. No audible or visual indication is emitted until the scanner receives an escape command. The scanner read illumination goes out when there’s a successful read.
- Scanner operation is suspended until 1) a valid escape string is received from the host system or 2) the scanner times out.
- Once condition 1 or 2 above has been met, the scanner is ready to scan again, and the process repeats.

A time-out occurs if the scanner does not receive a valid escape command within 10 seconds. A time-out is indicated by an error tone. If a time-out occurs, the operator should check the host system to understand why a response to the scanner was not received.

Host ACK On/Off



HSTACK1.
Host ACK On



HSTACK0.
* Host ACK Off

Host ACK Timeout

You can set a timeout for the length of time the scanner waits for a valid escape command when using Host Acknowledgment Mode. Set the length (in seconds) for a timeout by scanning the following barcode, then setting the timeout (from 1-90 seconds) by scanning digits from the [Programming Chart](#), beginning on page 311, then **Save**. *Default = 10.*



HSTATO.

Host ACK Timeout

Host ACK Responses

Command	Action
[ESC] a,	Double beeps to indicate a successful menu change was made.
[ESC] b,	Razz or error tone to indicate a menu change was unsuccessful.
[ESC] 1,	The green LED illuminates for 135 milliseconds followed by a pause.
[ESC] 2,	The green LED illuminates for 2 seconds followed by a pause.
[ESC] 3,	The green LED illuminates for 5 seconds followed by a pause.
[ESC] 4,	Emits a beep at a low pitch.
[ESC] 5,	Emits a beep at a medium pitch.
[ESC] 6,	Emits a beep at a high pitch.
[ESC] 7,	Beeps to indicate a successful decode and communication to host.
[ESC] 8,[ESC] 8,	Razz or error tone to indicate a decode/communication to host was unsuccessful.

Power Up Beeper

The scanner can be programmed to beep when it's powered up. If you are using a cordless system, the base can also be programmed to beep when it is powered up. Scan the **Off** barcode(s) if you don't want a power up beep. *Default = Power Up Beeper On - Scanner.*



BEPPWR0.

Power Up Beeper Off -
Scanner



BASPWR0.

Power Up Beeper Off -
Cordless Base



BEPPWR1.

* Power Up Beeper On -
Scanner



BASPWR1.

Power Up Beeper On -
Cordless Base

Beep on BEL Character

You may wish to force the scanner to beep upon a command sent from the host. If you scan the **Beep on BEL On** barcode below, the scanner will beep every time a BEL character is received from the host. *Default = Beep on BEL Off.*



Trigger Click

To hear an audible click every time the scanner trigger is pressed, scan the **Trigger Click On** barcode below. Scan the **Trigger Click Off** code if you don't wish to hear the click. (This feature has no effect on serial or automatic triggering.) *Default = Trigger Click Off.*



Good Read and Error Indicators

Beeper – Good Read

The beeper may be programmed **On** or **Off** in response to a good read. Turning this option off only turns off the beeper response to a good read indication. All error and menu beeps are still audible. *Default = Beeper - Good Read On.*



Beeper Volume – Good Read

The beeper volume codes modify the volume of the beep the scanner emits on a good read. *Default = High for Xenon XP, Low for Xenon XP healthcare scanners.*



BEPLVL1.

* Low



BEPLVL2.

Medium



BEPLVL3.

* High



BEPLVL0.

Off

Beeper Pitch – Good Read

The beeper pitch codes modify the pitch (frequency) of the beep the scanner emits on a good read. *Default = Medium.*



BEPFQ11600.

Low (1600 Hz)



BEPFQ12700.

* Medium (2700 Hz)



BEPFQ14200.

High (4200 Hz)

Vibrate – Good Read

The scanner vibrates once when a barcode is successfully read, and twice when a programming barcode is successfully read. When a programming barcode is unsuccessful, the scanner emits one long vibration (2 times the Vibrate Duration length). Scan **Vibrate – Good Read Off** to keep the scanner from vibrating. *Default = Vibrate - Good Read Off.*



TFBGRD0.

* Vibrate- Good Read Off



TFBGRD1.

Vibrate- Good Read On

Vibrate Duration

If you want to set the length for the good read vibration, scan the barcode below, then set the duration (from 100 - 2,000 milliseconds) by scanning digits from the [Programming Chart](#), beginning on page 311, then **Save**. *Default = 100 ms.*



TFBDUR.

Vibrate Duration

Beeper Pitch – Error

The beeper pitch codes modify the pitch (frequency) of the sound the scanner emits when there is a bad read or error. *Default = Razz.*



BEPFQ2250.

* Razz (250 Hz)



BEPFQ23250.

Medium (3250 Hz)



BEPFQ24200.

High (4200 Hz)

Beeper Duration – Good Read

The beeper duration codes modify the length of the beep the scanner emits on a good read. *Default = Normal.*



BEPBIP0.
* Normal Beep



BEPBIP1.
Short Beep

LED – Good Read

The LED indicator can be programmed **On** or **Off** in response to a good read. *Default = On.*



BEPLED1.
* LED - Good Read On



BEPLED0.
LED - Good Read Off

Number of Beeps – Good Read

The number of beeps of a good read can be programmed from 1 - 9. The same number of beeps will be applied to the beeper and LED in response to a good read. For example, if you program this option to have five beeps, there will be five beeps and five LED flashes in response to a good read. The beeps and LED flashes are in sync with one another. To change the number of beeps, scan the barcode below and then scan a digit (1-9) barcode from the [Programming Chart](#), beginning on page 311, then **Save**. *Default = 1.*



BEPRPT.
Number of Good Read Beeps/LED Flashes

Number of Beeps – Error

The number of beeps and LED flashes emitted by the scanner for a bad read or error can be programmed from 1 - 9. For example, if you program this option to have five error beeps, there will be five error beeps and five LED flashes in response

to an error. To change the number of error beeps, scan the barcode below and then scan a digit (1-9) barcode from the [Programming Chart](#), beginning on page 311, then **Save**. *Default = 1.*



BEPERR.

Number of Error Beeps/LED Flashes

Good Read Delay

This sets the minimum amount of time before the scanner can read another barcode. *Default = 0 ms (No Delay).*



DLYGRD0.

* No Delay



DLYGRD500.

Short Delay (500 ms)



DLYGRD1000.

Medium Delay (1,000 ms)



DLYGRD1500.

Long Delay (1,500 ms)

User-Specified Good Read Delay

If you want to set your own length for the good read delay, scan the barcode below, then set the delay (from 0 - 30,000 milliseconds) by scanning digits from the [Programming Chart](#), beginning on page 311, then **Save**.



DLYGRD.

User-Specified Good Read Delay

Trigger Modes

Manual Trigger

When in manual trigger mode, the scanner scans until a barcode is read, or until the trigger is released. Two modes are available, **Normal** and **Enhanced**. Normal mode offers good scan speed and the longest working ranges (depth of field). Enhanced mode will give you the highest possible scan speed but slightly less range than Normal mode. Enhanced mode is best used when you require a very fast scan speed and don't require a long working range. *Default = Manual Trigger-Normal.*



Trigger Toggle

Trigger Toggle mode lets you quickly hit the trigger two or three times to put the scanner into either imaging mode or centering mode, then toggle back to scanning. So, like a double-click with a mouse, you can control what the next scanner's action will be. For example, you could double-press the trigger to go into imaging mode, then the next trigger press takes the image. The scanner then reverts to scanning mode. Use the following codes to configure what action you would like the scanner to take when in Trigger Toggle mode.



Trigger Number

This sets the number of trigger presses required to activate the Trigger Toggle Mode.



TRGTPC2.

2 Quick Triggers



TRGTPC3.

3 Quick Triggers



TRGTPC4.

4 Quick Triggers

Trigger Timing

This sets the timing of the trigger presses in order to qualify as a trigger toggle, rather than a regular trigger press. After scanning the **Trigger Timing** barcode, set the time-out duration (from 50-2,000 milliseconds) by scanning digits from the [Programming Chart](#), beginning on page 311, then **Save**. *Default = 400ms.*



TRGTTI.

Trigger Timing

Trigger Toggle Timeout

This sets the length of time the scanner stays in trigger toggle mode before reverting to scan mode. After scanning the **Trigger Toggle Timeout** barcode, set the time-out duration (from 0 to 65 seconds) by scanning digits from the [Programming Chart](#), beginning on page 311, then **Save**. *Default = 5 seconds.*

Note: *If this is set to 0, you must repeat the toggle sequence to return to the default scanning mode. For example, if 2 quick trigger presses puts the scanner into centering mode and the Trigger Timing is 0, you would have to do 2 quick presses again to go back to the default scanning mode.*



TRGTGT.

Trigger Toggle Timeout

Serial Trigger

You can activate the scanner either by pressing the trigger, or using a serial trigger command (see [Trigger Commands](#) on page 242). You must be in a serial interface mode in order to use serial triggering. Refer to [RS232 Serial Port](#) (page 16) or [USB Serial](#) (page 18) for further information. When in serial mode, the scanner scans until a barcode has been read or until the deactivate command is sent. The scanner can also be set to turn itself off after a specified time has elapsed (see [Read Time-Out](#), which follows).

Read Time-Out

Use this selection to set a time-out (in milliseconds) of the scanner's trigger when using serial commands to trigger the scanner. Once the scanner has timed out, you can activate the scanner either by pressing the trigger or using a serial trigger command. After scanning the **Read Time-Out** barcode, set the time-out duration (from 0-300,000 milliseconds) by scanning digits from the [Programming Chart](#), beginning on page 311, then **Save**. *Default = 30,000 ms.*



Presentation Mode

Presentation Mode uses ambient light and scanner illumination to detect barcodes. When in Presentation Mode, the LEDs remain dim until a barcode is presented to the scanner, then the aimer turns on and the LEDs turn up to read the code. If the light level in the room is not high enough, Presentation Mode may not work properly.

Note: *If you are using a cordless charge base in Presentation Mode, the battery will not charge unless the power supply is plugged into the base's auxiliary power port.*

Scan the following barcode to program your scanner for Presentation Mode.



Triggered Presentation Mode

This mode uses light to detect the presence of an object. *Default = Ambient and Scanner Light.*



PDCLED0.
Ambient Light Only



PDCLED1.
*Ambient and Scanner Light

Presentation LED Behavior after Decode

When a scanner is in presentation mode, the LED aimer dims 30 seconds after a barcode is decoded. If you wish to dim the LED aimer immediately after a barcode is decoded, scan the **LEDs Off** barcode, below. *Default = LEDs On.*



TRGPCK1.
* LEDs On



TRGPCK0.
LEDs Off

Presentation Centering

Use Presentation Centering to narrow the scanner's field of view when it is in the stand to make sure the scanner reads only those barcodes intended by the user. For instance, if multiple codes are placed closely together, Presentation Centering will insure that only the desired codes are read.

Note: To adjust centering when the scanner is hand-held, see [Centering](#) (page 100).

If a barcode is not touched by a predefined window, it will not be decoded or output by the scanner. If Presentation Centering is turned on by scanning **Presentation Centering On**, the scanner only reads codes that pass through the centering window you specify using the **Top of Presentation Centering Window**, **Bottom of Presentation Centering Window**, **Left**, and **Right of Presentation Centering Window** barcodes.

In the example below, the white box is the centering window. The centering window has been set to 20% left, 30% right, 8% top, and 25% bottom. Since Barcode 1 passes through the centering window, it will be read. Barcode 2 does not pass through the centering window, so it will not be read.

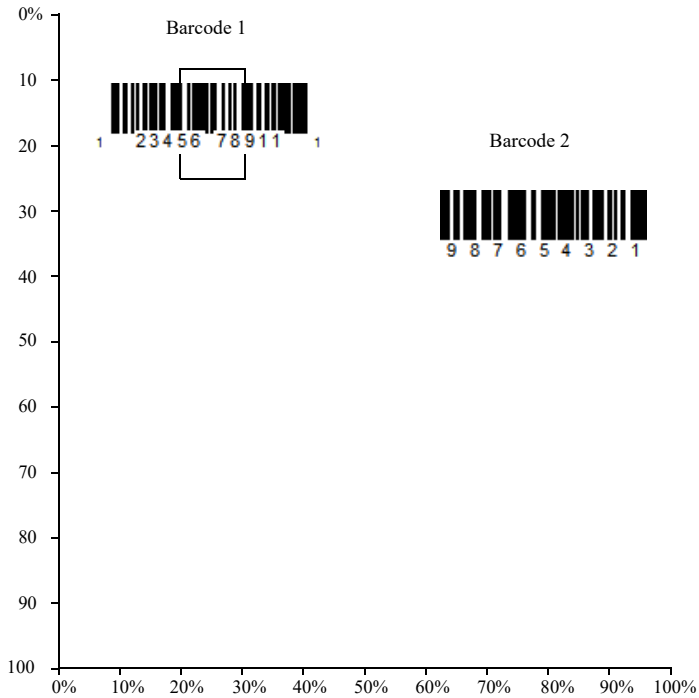

Note: A barcode needs only to be touched by the centering window in order to be read. It does not need to pass completely through the centering window.

Scan **Presentation Centering On**, then scan one of the following barcodes to change the top, bottom, left, or right of the centering window. Then scan the percent you want to shift the centering window from the [Programming Chart](#), beginning on page 311, then **Save**. Default Presentation Centering = 40% for Top and Left, 60% for Bottom and Right.





In-Stand Sensor Mode

Note: The In-Stand Sensor feature only applies to Xenon XP 1950g, 1950h, 1952g, and 1952h products. It does not apply to the Xenon XP 1952-BF products.

This feature senses when the scanner is removed from the stand and tells it to begin manual triggering. When **Sensor On** is enabled, the scanner defaults to Streaming Presentation Mode when it is in the stand, and to Manual Trigger Mode when it is removed from the stand. *Default = Sensor On.*



Note: If you are taking images (see [Imaging Commands](#) beginning on page 215), you must set the In-Stand Sensor to **Off**.

Poor Quality Codes

Poor Quality 1D Codes

This setting improves the scanner's ability to read damaged or badly printed linear barcodes. When **Poor Quality 1D Reading On** is scanned, poor quality linear barcode reading is improved, but the scanner's snappiness is decreased, making it less aggressive when reading good quality barcodes. This setting does not affect 2D barcode reading. *Default = Poor Quality 1D Reading Off.*





* Poor Quality 1D Reading Off

Poor Quality PDF Codes

This setting improves the scanner's ability to read damaged or badly printed PDF codes by combining information from multiple images. It is useful when a complete barcode cannot be seen in one image. This setting does not affect 1D barcode reading. *Default = Poor Quality PDF Reading On.*



*Poor Quality PDF Reading On



Poor Quality PDF Reading Off

Low Resolution PDF Codes

This setting improves the scanner's ability to read low resolution PDF codes. When **Low Resolution PDF Codes On** is scanned, poor quality PDF code reading is improved, but the scanner's snappiness is decreased, making it less aggressive when reading good quality barcodes. This setting does not affect 1D barcode reading. *Default = Low Resolution PDF Codes Off.*



Low Resolution PDF Codes On



* Low Resolution PDF Codes Off

CodeGate™

When CodeGate is **On**, the trigger is used to allow decoded data to be transmitted to the host system. The scanner remains on, scanning and decoding barcodes, but the barcode data is not transmitted until the trigger is pressed. When CodeGate is **Off**, barcode data is transmitted when it is decoded. *Default = CodeGate Off Out-of-Stand.*



Streaming Presentation™ Mode

When in Streaming Presentation mode, the scanner's aimer goes out after a short time, but the scan illumination remains on all the time to continuously search for barcodes. Two modes are available, **Normal** and **Enhanced**. Normal mode offers good scan speed and the longest working ranges (depth of field). Enhanced mode will give you the highest possible scan speed but slightly less range than Normal mode. Enhanced mode is best used when you require a very fast scan speed and don't require a long working range.



When using [Preferred Symbology](#) (page 102), a lower priority symbol must be centered on the aiming pattern to be read in Streaming Presentation Mode.

Note: *If you are using a cordless charge base, it must have an external power supply plugged into the aux port for Streaming Presentation to work properly.*

Streaming Presentation In-Stand

This option is available when using [In-Stand Sensor Mode](#), page 92. You may program a specific Streaming Presentation Mode for in-stand scanning, and a Manual Trigger mode for out-of-stand scanning. To do this, you must first scan the preferred Streaming Presentation mode (Normal or Enhanced), then scan the Manual Trigger mode (Normal or Enhanced) you want to use.

Hands Free Time-Out

The Scan Stand and Presentation Modes are referred to as “hands free” modes. If the scanner’s trigger is pulled when using a hands free mode, the scanner changes to manual trigger mode. You can set the time the scanner should remain in manual trigger mode by setting the Hands Free Time-Out. Once the time-out value is reached, (if there have been no further trigger pulls) the scanner reverts to the original hands free mode.

Scan the **Hands Free Time-Out** barcode, then scan the time-out duration (from 0-300,000 milliseconds) from the [Programming Chart](#), beginning on page 311, then **Save**. *Default = 5,000 ms.*



TRGPTO.

Hands Free Time-Out

Reread Delay

This sets the time period before the scanner can read the *same* barcode a second time. Setting a reread delay protects against accidental rereads of the same barcode. Longer delays are effective in minimizing accidental rereads. Use shorter delays in applications where repetitive barcode scanning is required. Reread Delay only works when in a [Presentation Mode](#) (see page 89). *Default = Medium.*



DLYRRD500.

Short (500 ms)



DLYRRD750.

* Medium (750 ms)



DLYRRD1000.

Long (1000 ms)



User-Specified Reread Delay

If you want to set your own length for the reread delay, scan the barcode below, then set the delay (from 0-30,000 milliseconds) by scanning digits from the [Programming Chart](#), beginning on page 311, then **Save**.



2D Reread Delay

Sometimes 2D barcodes can take longer to read than other barcodes. If you wish to set a separate Reread Delay for 2D barcodes, scan one of the programming codes that follows. **2D Reread Delay Off** indicates that the time set for [Reread Delay](#) is used for both 1D and 2D barcodes. *Default = 2D Reread Delay Off.*



Character Activation

You may use a character sent from the host to trigger the scanner to begin scanning. When the activation character is received, the scanner continues scanning until either the [Character Activation Timeout](#) (page 98) is reached, the deactivation character is received (see [Deactivation Character](#) on page 98), or a barcode is transmitted. Scan the **On** barcode to use character activation, then use [Activation Character](#) (page 97) to select the character you will send from the host to start scanning. *Default = Off.*



Activation Character

This sets the character used to trigger scanning when using Character Activation Mode. On the [ASCII Conversion Chart \(Code Page 1252\)](#), page 300, find the hex value that represents the character you want to use to trigger scanning. Scan the following barcode, then use the [Programming Chart](#) to read the alphanumeric combination that represents that ASCII character. Scan **Save** to finish. *Default = 12 [DC2].*



End Character Activation After Good Read

After a barcode is successfully detected and read from the scanner, the illumination can be programmed either to remain on and scanning, or to turn off. When **End Character Activation After Good Read** is enabled, the illumination turns off and stops scanning after a good read. If you scan **Do Not End Character Activation After Good Read**, the illumination remains on after a good read.





HSTCGD1.

End Character Activation After Good Read

Character Activation Timeout

You can set a timeout for the length of time the illumination remains on and attempting to decode barcodes when using Character Activation Mode. Set the length (in milliseconds) for a timeout by scanning the following barcode, then setting the timeout (from 1-300,000 milliseconds) by scanning digits from the [Programming Chart](#), beginning on page 311, then **Save**. *Default = 30,000 ms.*



HSTCDT.

Character Activation Timeout

Character Deactivation

If you have sent a character from the host to trigger the scanner to begin scanning, you can also send a deactivation character to stop scanning. Scan the following **On** barcode to use character deactivation, then use **Deactivation Character** (following) to select the character you will send from the host to terminate scanning. *Default = Off.*



HSTDEN0.

* Off



HSTDEN1.

On

Deactivation Character

This sets the character used to terminate scanning when using Character Deactivation Mode. On the [ASCII Conversion Chart \(Code Page 1252\)](#), page 300, find the hex value that represents the character you want to use to terminate scanning. Scan the following barcode, then use the [Programming Chart](#), beginning on page 311 to read the alphanumeric combination that represents that ASCII character. Scan **Save** to finish. *Default = 14 [DC4].*



HSTDCH.

Deactivation Character

Illumination Lights

If you want the illumination lights on while reading a barcode, scan the **Lights On** barcode, below. However, if you want to turn just the lights off, scan the **Lights Off** barcode. *Default = Lights On.*

Note: *This setting does not affect the aimer light. The aiming light can be set using [Aimer Mode](#) (page 100).*



Aimer Delay

The aimer delay allows a delay time for the operator to aim the scanner before the picture is taken. Use these codes to set the time between when the trigger is pulled and when the picture is taken. During the delay time, the aiming light will appear, but the LEDs won't turn on until the delay time is over. *Default = Off.*



User-Specified Aimer Delay

If you want to set your own length for the duration of the delay, scan the barcode below, then set the time-out by scanning digits (0 - 4,000 ms) from the [Programming Chart](#), beginning on page 311, then **Save**.



Aimer Mode

This feature allows you to turn the aimer on and off. When the **Interlaced** barcode is scanned, the aimer is interlaced with the illumination LEDs. *Default = Interlaced*



Centering

Use Centering to narrow the scanner's field of view to make sure that when the scanner is hand-held, it reads only those barcodes intended by the user. For instance, if multiple codes are placed closely together, centering will insure that only the desired codes are read. (Centering can be used in conjunction with [Aimer Delay](#), page 99, for the most error-free operation in applications where multiple codes are spaced closely together. Using the Aimer Delay and Centering features, the scanner can emulate the operation of older systems, such as linear laser barcode scanners.)

Note: To adjust centering when the scanner is in a stand, see [Presentation Centering](#) (page 90).

Single Code Centering

Scan **Single Code Centering** to target the barcode closest to the center of the image. Singling out a barcode in this manner increases scanning accuracy when there are multiple barcodes close together.



Single Code Centering

Custom Centering

Use the following settings to customize your centering window. If a barcode is not touched by a predefined window, it will not be decoded or output by the scanner. If centering is turned on by scanning **Centering On**, the scanner only reads codes that pass through the centering window you specify using the **Top of Centering Window**, **Bottom of Centering Window**, **Left**, and **Right of Centering Window** barcodes.

Example: In the example below, the white box is the centering window. The centering window has been set to 20% left, 30% right, 8% top, and 25% bottom. Since Barcode 1 passes through the centering window, it will be read. Barcode 2 does not pass through the centering window, so it will not be read.

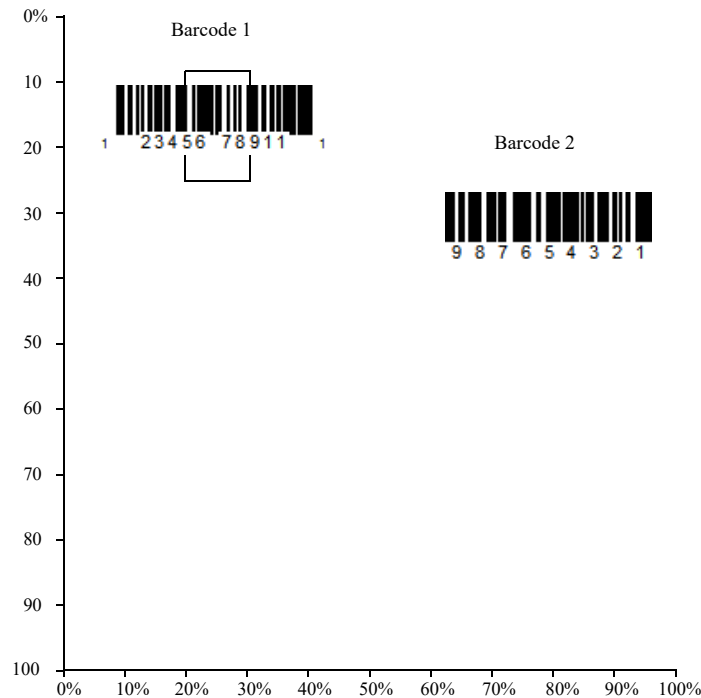

Note: A barcode needs only to be touched by the centering window in order to be read. It

does not need to pass completely through the centering window.

Scan **Centering On**, then scan one of the following barcodes to change the top, bottom, left, or right of the centering window. Then scan the percent you want to shift the centering window using digits from the [Programming Chart](#), beginning on page 311, then **Save**. *Default Centering = 40% for Top and Left, 60% for Bottom and Right.*



DECWIN1.
Centering On



DECWIN0.
* Centering Off



DECTOP.
Top of Centering Window



DECBOT.
Bottom of Centering Window



DECLFT.
Left of Centering Window



DECRGT.
Right of Centering Window

Preferred Symbology

The scanner can be programmed to specify one symbology as a higher priority over other symbologies in situations where both barcode symbologies appear on the same label, but the lower priority symbology cannot be disabled.

For example, you may be using the scanner in a retail setting to read U.P.C. symbols, but have occasional need to read a code on a drivers license. Since some licenses have a Code 39 symbol as well as the PDF417 symbol, you can use Preferred Symbology to specify that the PDF417 symbol be read instead of the Code 39.

Preferred Symbology classifies each symbology as high priority, low priority, or as an unspecified type. When a low priority symbology is presented, the scanner ignores it for a set period of time (see [Preferred Symbology Time-out](#) on page 104) while it searches for the high priority symbology. If a high priority symbology is located during this period, then that data is read immediately.

If the time-out period expires before a high priority symbology is read, the scanner will read any barcode in its view (low priority or unspecified). If there is no barcode in the scanner's view after the time-out period expires, then no data is reported.

Note: A low priority symbol must be centered on the aiming pattern to be read.

Scan a barcode below to enable or disable Preferred Symbology. *Default = Preferred Symbology Off.*



PRFENA1.

Preferred Symbology On



PRFENA0.

*** Preferred Symbology Off**

High Priority Symbology

To specify the high priority symbology, scan the **High Priority Symbology** barcode below. On the [Symbology Charts](#) on page 297, find the symbology you want to set as high priority. Locate the Hex value for that symbology and scan the 2 digit hex value from the [Programming Chart](#), beginning on page 311, then **Save**. *Default = None.*



PRFCOD.

High Priority Symbology

Low Priority Symbology

To specify the low priority symbology, scan the **Low Priority Symbology** barcode below. On the [Symbology Charts](#) on page 297, find the symbology you want to set as low priority. Locate the Hex value for that symbology and scan the 2 digit hex value from the [Programming Chart](#), beginning on page 311.

If you want to set additional low priority symbologies, scan **FF**, then scan the 2 digit hex value from the [Programming Chart](#), beginning on page 311, for the next symbology. You can program up to 5 low priority symbologies. Scan **Save** to save your selection. *Default = None.*



PRFBLK.

Low Priority Symbology

Preferred Symbology Time-out

Once you have enabled Preferred Symbology and entered the high and low priority symbologies, you must set the time-out period. This is the period of time the scanner will search for a high priority barcode after a low priority barcode has been encountered. Scan the barcode below, then set the delay (from 1-3,000 milliseconds) by scanning digits from the [Programming Chart](#), beginning on page 311, then **Save**. *Default = 500 ms.*



PRFPTO.

Preferred Symbology Time-out

Preferred Symbology Default

Scan the barcode below to set all Preferred Symbology entries to their default values.



PRFDFT.

Preferred Symbology Default

Output Sequence Overview

Output Sequence Editor

This programming selection allows you to program the scanner to output data (when scanning more than one symbol) in whatever order your application requires, regardless of the order in which the barcodes are scanned. You can define up to 15 barcodes in an output sequence.

Note: *To make Output Sequence Editor selections, you'll need to know the code I.D., code length, and character match(es) your application requires. Use the alphanumeric symbols from the [Programming Chart](#), beginning on page 311. You must hold the trigger while reading each barcode in the sequence.*

To Add an Output Sequence

An output sequence is created using a string of serial commands that is sent to the scanner. This string is most easily sent to the scanner using the EZConfig software tool (see [EZConfig for Scanning Introduction](#) on page 237). You can also accomplish this by scanning alphanumeric barcodes (see the [Programming Chart](#), beginning on page 311).

1. If you are using barcodes to create your output sequence, scan [Enter Output Sequence](#) on page 108.
2. **Code I.D.**
On the [Symbology Charts](#) on page 297, find the symbology to which you want to apply the output sequence format. Make a note of the hex value for that symbology. If you are using barcodes to create your output sequence, scan the 2 digit hex value from the [Programming Chart](#), beginning on page 311.
3. **Length**
Specify what length (up to 9999 characters) of data output will be acceptable for this symbology. Make a note of the length. If you are using barcodes to create your output sequence, scan the 4 digit data length [Programming Chart](#), beginning on page 311. (Note: 50 characters is entered as **0050**. 9999 is a universal number, indicating all lengths.) When calculating the length, you must count any programmed prefixes, suffixes, or formatted characters as part of the length (unless using 9999).
4. **Character Match Sequences**
On the [ASCII Conversion Chart \(Code Page 1252\)](#), page 300, find the hex value that represents the character(s) you want to match. Make a note of the hex value for the character(s). If you are using barcodes to create your output sequence, use the [Programming Chart](#), beginning on page 311 to read the alphanumeric combination that represents the ASCII characters. (99 is the universal number, indicating all characters.)
5. **End Output Sequence Editor**
Use **FF** to terminate this string or to begin another output sequence. If you are using barcodes, scan **F F**. Scan **Save** to save your entries.

Other Programming Selections

If you are creating an output sequence using barcodes, scan **Discard** ([page 312](#)) to exit without saving any output sequence changes.

Output Sequence Editor Commands

SEQBLK	Sequence editor start command.
SEQPRE	Add prefix to complete output sequences.
SEQSUF	Add suffix to complete output sequences.
SEQSEP	Add separators to complete output sequences.
SEQTTS1	Transmit partial sequence.
SEQSAT	Define satisfactory subsets of full output sequence.
SEQTIM	Timeout for sequence members when using SEQSAT.
SEQIPR	Add prefix to partial output sequences.

SEQISU	Add suffix to partial output sequences.
SEQISE	Add separators to partial output sequences.
TRGSTO	Timeout for partial output sequences.
FF	Termination string.
SEQ_EN1	Require output sequence on/not required.
SEQ_EN2	Require output sequence required.
BEPSINO	Good read beep - each code in sequence.
BEPSIN1	Good read click - each code in sequence.
BEPISEO	Good read beep - partial sequence output.
BEPISE1	Error tone - partial sequence output.

Examples outlining how to use these commands are shown below.

Output Sequence Example 1 - Three Symbologies



In this example, you are scanning PDF417, Code 128, and Code 39 barcodes, but you want the scanner to output Code 39 first, Code 128 second, and PDF417 third.

Set up the sequence editor with the following command line:

SEQBLK	sequence editor start command
62	code identifier for Code 39
9999	code length that must match for Code 39, 9999 = all lengths
43	start character match for Code 39, 43h = "C"
FF	termination string for first code
6A	code identifier for Code 128
9999	code length that must match for Code 128, 9999 = all lengths
54	start character match for Code 128, 54h = "T"
FF	termination string for first code
72	code identifier for PDF417

9999	code length that must match for PDF417, 9999 = all lengths
4D	start character match for PDF417, 4Dh = "M"
FF	termination string for third code

The whole command line would look like this:

SEQBLK62999943FF6A999954FF7299994DFF.



SEQDFT;SEQ_EN1;SEQBLK62999943FF6A999954FF7299994DFF.

SEQDFT;SEQ_EN1;SEQBLK62999943FF6A999954FF7299994DFF.

The data is output as:

CODE39SMPLTSTMSGCODE128MSGPDF417

Output Sequence Example 2 - Three Symbologies with <> Separators

In this example, you are scanning the same three barcodes, but you want <> brackets and a carriage return and line feed to separate your output.



The sequence editor would use the same command line as shown in [Output Sequence Example 1 - Three Symbologies](#) (page 106):

SEQBLK	sequence editor start command
62	code identifier for Code 39
9999	code length that must match for Code 39, 9999 = all lengths
43	start character match for Code 39, 43h = "C"
FF	termination string for first code
6A	code identifier for Code 128
9999	code length that must match for Code 128, 9999 = all lengths
54	start character match for Code 128, 54h = "T"

FF	termination string for first code
72	code identifier for PDF417
9999	code length that must match for PDF417, 9999 = all lengths
4D	start character match for PDF417, 4Dh = "M"
FF	termination string for third code

But you would add your <> separators for each sequence:

SEQSEP99	separator for each sequence, 99 = all symbologies
3C	left bracket (<)
3E	right bracket (>)

And add the carriage return and line feed as a suffix:

SEQSUF99	separator for suffixes, 99 = all symbologies
0D	carriage return
0A	line feed

The whole command line would look like this:

SEQBLK62999943FF6A999954FF7299994DFF;SEQSEP993C3E;SEQSUF990D0A.



SEQDFT;SEQ_EN1;SEQBLK6299...

SEQDFT;SEQ_EN1;SEQBLK62999943FF6A999954FF7299994DFF;SEQSEP993C3E;SEQSUF990D0A.

The data is output as:

CODE39SMPL<>TSTMSGCODE128<>MSGPDF417 [CR] [LF]

Enter Output Sequence

If you are using barcodes to create your output sequence, scan **Enter Output Sequence** to begin scanning your string.



SEQBLK.

Enter Output Sequence

Partial Sequence

If an output sequence operation is terminated before all your output sequence criteria are met, the barcode data acquired to that point is a “partial sequence.” You can define how partial sequences are output using the same types of command strings you used to create output sequences.

Partial Sequence Example - Three Symbologies with <> Separators, but with a Damaged Code

In this example, you are scanning PDF417, Code 128, and Code 39 barcodes, and you want the scanner to output Code 39 first, Code 128 second, and PDF417 third, in brackets, as shown below, but the Code 39 barcode has been damaged and cannot be output.



You would use the same command line as shown in [Output Sequence Example 2 - Three Symbologies with <> Separators](#) (page 107):

SEQBLK	sequence editor start command
62	code identifier for Code 39
9999	code length that must match for Code 39, 9999 = all lengths
43	start character match for Code 39, 43h = "C"
FF	termination string for first code
6A	code identifier for Code 128
9999	code length that must match for Code 128, 9999 = all lengths
54	start character match for Code 128, 54h = "T"
FF	termination string for first code
72	code identifier for PDF417
9999	code length that must match for PDF417, 9999 = all lengths
4D	start character match for PDF417, 4Dh = "M"
FF	termination string for third code

But you would add your <> separators for each sequence:

SEQISE99	separator for each sequence, 99 = all symbologies
3C	left bracket (<)
3E	right bracket (>)

And add the carriage return and line feed as a suffix:

SEQISU99	separator for suffixes, 99 = all symbologies
0D	carriage return
0A	line feed

And you would add >**PARTIAL**< as the prefix to note the partial sequence:

SEQTTS1	transmit partial sequence
SEQIPR99	add partial sequence prefix, 99 = all symbologies
3E	right bracket (>)
50	P
41	A
52	R
54	T
49	I
41	A
4C	L
3C	left bracket (<)

The whole command line would look like this:

SEQBLK62999943FF6A999954FF7299994DFF;SEQISE993C3E;SEQISU990D0A;SEQTTS1;SEQIPR993E5041525449414C3C.



SEQDFT;SEQ_EN1;SEQBLK6299...

SEQDFT;SEQ_EN1;SEQBLK62999943FF6A999954FF7299994DFF;SEQISE993C3E;SEQISU990D0A;SEQTTS1;SEQIPR993E5041525449414C3C.

The data is output as:

>PARTIAL<TSTMSGCODE128<>MSGPDF417 [CR] [LF]

Discard Partial Output Sequence

If you want to discard partial sequences when the output sequence operation is terminated before completion, scan **Discard Partial Sequence**.



SEQTTS0.

* Discard Partial Sequence

Output Sequence Timeouts

You can set a timeout for every code in the output sequence defined by the SEQBLK command. The scanner applies the shortest timeout corresponding to any of the codes that have been read during the current trigger session. When the timeout expires, the scanner sends all codes that it has been read in the order they appear in the sequence defined by SEQBLK.

To specify the timeout, use the SEQTIM command followed by a list of timeouts in milliseconds. Each timeout is specified as a 4-decimal digit terminated by FF. The timeout value 9999 is special and indicates that the timeout for that code is “infinite”.

The number of timeouts specified should correspond to the number of codes in the sequence defined by SEQBLK. You can specify one additional timeout, which will apply to codes not matching any member of the sequence. This can be useful if Require Output Sequence is **On/Not Required**. If you do not specify an additional timeout for codes not in the defined sequence, the last timeout specified by SEQTIM will apply.

Output Sequence Timeout Example

For example, if SEQBLK defines a 4-code sequence, you can specify timeouts of 5, 6, 7, and 8 seconds for codes 1-4 respectively using the command **SEQTIM5000FF6000FF7000FF8000FF**. Codes that are not part of the defined sequence would have an implied timeout of 8 seconds in this case (the final timeout in the list). To explicitly specify a timeout for such codes, you can include one more timeout at the end of the list. For example, to include a timeout of 1 second for non-sequence codes, use the command **SEQTIM5000FF6000FF7000FF8000FF1000FF**.

Satisfactory Subset of Full Sequence

You can define one or more subsets of barcodes from the complete sequence specified by SEQBLK. When you scan all the codes from one of these subsets, the scanner will transmit all the codes it has read in the sequence. The scanner sends the codes in the order defined by SEQBLK.

Note: To use the satisfactory subset feature, you must supply a timeout for each code in the sequence using SEQTIM.

Satisfactory Subset of Full Sequence Timeout Example

To specify a subset, list its members using the SEQSAT command and terminate each subset with FF. The members of each subset are specified as single hex digits corresponding to their index within the full sequence, 1 being the first. For example, to specify two subsets, the first consisting of the first and second code in the sequence and the second subset consisting of the second and third code, use the command **SEQSAT12FF23FF**.

To define a subset with an odd number of codes, insert a 0 before the final code index. For example, to define a 3-code subset consisting of the first, second, and third codes, use the command **SEQSAT1203FF**.

In this example command **SEQBLK62999943FF6A999954FF7299994DFF** will set the first code in the sequence to Code 39 “C”, second code to Code 128 “T”, and third code to PDF417 “M”.

The command **SEQSAT01FF23FF** will satisfy the sequence if either Position 1 is scanned or Position 2 and 3 are scanned, it will send out the position 1 barcode or Position 2 and 3 barcode right away.



SEQDFT;SEQ_EN1;SEQBLK6299...

SEQDFT;SEQ_EN1;SEQBLK62999943FF6A999954FF7299994DFF;SEQSEP993D3E;SEQSUF990D0A;
SEQSAT01FF23FF;SEQTIM5000FF6000FF7000FF8000FF.

Verify the below combination output sequence:

1. Scan Code 39. Output **CODE39SMPL**
2. Scan Code 128, and then scan Code 39 and wait for timeout. Output **CODE39SMPLTSTMSGCODE128**
3. Scan PDF417, and then scan Code 39 and wait for timeout. Output **CODE39SMPLMSGPD417**
4. Scan Code 128, and then scan PDF417. Output **TSTMSGCODE128MSGPDF417**
5. Scan PDF417, and then scan Code 128. Output **TSTMSGCODE128MSGPDF417**



SEQDFT;SEQ_EN1;SEQBLK6299...

SEQDFT;SEQ_EN1;SEQBLK62999943FF6A999954FF7299994DFF;SEQSEP993D3E;SEQSUF990D0A;
SEQSAT01FF23FF;SEQTIM5000FF6000FF7000FF8000FF;SEQTTS1.

Verify the combination with SEQTTS1:

1. First scan Code 39. Output **CODE39SMPL**
2. First scan Code 128, and then scan Code 39 and wait for timeout. Output **CODE39SMPLTSTMSGCODE128**
3. First scan PDF417, and then scan Code 39 and wait for timeout. Output **CODE39SMPLMSGPDF417**
4. First scan Code 128, and then scan PDF417. Output **TSTMSGCODE128MSGPDF417**
5. First scan PDF417, and then scan Code 128. Output **TSTMSGCODE128MSGPDF417**

Default Output Sequence

Default Sequence programs the scanner to all universal values. Be certain you want to delete or clear all formats before you read the **Default Sequence** symbol.



Require Output Sequence

When an output sequence is **Required**, all output data must conform to an edited sequence or the scanner will not transmit the output data to the host device. When it's **On/Not Required**, the scanner will attempt to get the output data to conform to an edited sequence but, if it cannot, the scanner transmits all output data to the host device as is, or formatted according to the partial sequence output format (see [Partial Sequence](#) on page 109).

When the output sequence is **Off**, the barcode data is output to the host as the scanner decodes it. *Default = Off.*

Note: This selection is unavailable when the Multiple Symbols Selection is turned on.



Good Read Tone - Output Sequences

The scanner may be programmed to either beep or click in response to a good read of each barcode in an output sequence, or to emit a beep or error tone for a partial sequence. *Default = Good Read Click - Each Code in Sequence and Error Tone - Partial Sequence Output.*



Good Read Beep - Each Code in Sequence



*** Good Read Click - Each Code in Sequence**



Good Read Beep - Partial Sequence Output



*** Error Tone - Partial Sequence Output**

Multiple Symbols

When this programming selection is turned **On**, it allows you to read multiple symbols with a single pull of the scanner's trigger. If you press and hold the trigger, aiming the scanner at a series of symbols, it reads unique symbols once, beeping and or vibrating (if turned on) for each read. The scanner attempts to find and decode new symbols as long as the trigger is pulled. The maximum number of barcodes read is 21. When this programming selection is turned **Off**, the scanner will only read the symbol closest to the aiming beam. *Default = Off.*



No Read

With No Read turned **On**, the scanner notifies you if a code cannot be read. If using an EZConfig-Scanning Tool Scan Data Window (see page 237), an “NR” appears when a code cannot be read. If No Read is turned **Off**, the “NR” will not appear.
Default = Off.



If you want a different notation than “NR,” for example, “Error,” or “Bad Code,” you can edit the output message (see [Data Format](#) beginning on page 131). The hex code for the No Read symbol is **9C**.

Video Reverse

Video Reverse is used to allow the scanner to read barcodes that are inverted. The **Video Reverse Off** barcode below is an example of this type of barcode. Scan **Video Reverse Only** to read *only* inverted barcodes. Scan **Video Reverse and Standard Barcodes** to read both types of codes.

Note: After scanning **Video Reverse Only**, menu barcodes cannot be read. You must scan **Video Reverse Off** or **Video Reverse and Standard Barcodes** in order to read menu barcodes.

Note: Images downloaded from the unit are not reversed. This is a setting for decoding only.





* Video Reverse Off

Working Orientation

Some barcodes are direction-sensitive. For example, KIX codes and OCR can misread when scanned sideways or upside down. Use the working orientation settings if your direction-sensitive codes will not usually be presented upright to the scanner. *Default = Upright.*

Upright:



Upside Down:



Vertical, Top to Bottom:
(Rotate CW 90°)

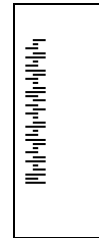

Vertical, Bottom to Top:
(Rotate CCW 90°)



ROTATN0.

* Upright



ROTATN2.

Upside Down



ROTATN1.

Vertical, Bottom to Top



ROTATN3.

Vertical, Top to Bottom

The following settings have been developed to enhance scanning in a healthcare environment. These settings are only supported by the Xenon XP 1950h scanner and the Xenon XP 1952h and Xenon XP 1952h-BF scanner and base. They allow you to set quickly configure streaming presentation, and to set the scanner and base to quiet modes for scanning that do not disturb resting patients.

Quiet Operations - Combination Codes

The following combination codes program your Xenon XP healthcare scanner and base for silent or quiet settings using a single programming code. If you wish to program some of these quiet settings individually, refer to [Quiet Operations - LED and Volume Settings](#), beginning on page 119.

Silent Mode with Flashing LED

Scan the following barcode to completely silence the scanner and base. The scanner beep, base beep, base and scanner power up beep, and scanner linking sounds are all silenced. When a barcode is scanned, the LED and aimer flash 5 times. Green indicates a good scan, red indicates a bad scan.



**Silent Mode with Flashing LED -
Cordless Scanner and Base**



**Silent Mode with Flashing LED -
Corded Scanner**

Silent Mode with Long LED

Scan the following barcode to completely silence the scanner and base. The scanner beep, base beep, base and scanner power up beep, and scanner linking sounds are all silenced. When a barcode is scanned, the LED and aimer remain solidly lit for 1 second. Green indicates a good scan, red indicates a bad scan.



**Silent Mode with Long LED -
Cordless Scanner and Base**



**Silent Mode with Long LED -
Corded Scanner**

Very Low Beeper (Nighttime Mode)

The following barcode silences the base, and sets the scanner for a very low beep when reading barcodes. After scanning this code, the base beep, base and scanner power up beep, and scanner linking sounds are all silenced. When a barcode is scanned, the scanner emits a very soft beep.



**Nighttime Mode -
Cordless Scanner and Base**



**Nighttime Mode -
Corded Scanner**

Low Beeper (Daytime Mode)

The following barcode sets all sounds to on, but at a low volume. The scanner beep, base beep, base and scanner power up beep, and scanner linking sounds are all set to low volume.



Daytime Mode -
Cordless Scanner and Base



Daytime Mode -
Corded Scanner

To reset your scanner and base to default sounds, refer to [Reset the Custom Defaults](#) (page 243).

Quiet Operations - LED and Volume Settings

If you have silenced or muted the scanner and base sounds, you may wish to adjust the visual (LED) indicators for Bluetooth linking sounds, scanning sounds, paging sounds, and out of range alarm sounds.

Linking LED Colors and Sound

Note: This setting is not supported by the Xenon XP 1950h scanner.

Under normal operations, the scanner chirps when linking to a base or an access point, and the LED on both the base and scanner flash green. If you want to silence all sounds and set both devices to flash red LEDs to indicate the linking status, scan the **Red LED Flashes/Silent** barcode below. The LEDs flash red while linking, then green to indicate the base and scanner are linked. To return to the default LED colors and sound, scan **Green LED Flashes/Sound**. Default = Green LED Flashes/Sound.



BEPPAR1.

* Green LED Flashes/Sound



BEPPAR0.

Red LED Flashes/Silent

Number of LED Flashes

If you have silenced the scanner's beeper, you may set the number of times the LED flashes when reading barcodes. *Default = 1 LED Flash.*

Note: If you have set [LED Solid \(No Flash\)](#) (page 121), to anything but **Off**, that setting will override the LED Flash settings. In that case, scan the **LED Solid Off** barcode to turn off this feature, then scan the LED Flash code you wish to use.



BEPLFN0.

* 1 LED Flash



BEPLFN5.

5 LED Flashes



BEPLFN10.

10 LED Flashes



BEPLFN25.

25 LED Flashes

LED Flash Rate

If you have silenced the scanner's beeper, you may set the how quickly the LED flashes when reading barcodes. *Default = Fast Flash.*



BEPLFR50.

* Fast Flash



BEPLFR250.

Medium Flash



BEPLFR500.

Slow Flash

LED Solid (No Flash)

Under normal operations, the scanner's LED flashes once for a good read. You may set the LED to remain on for a length of time after a good read instead of flashing. *Default = LED Solid Off (Resume Flash).*



BEPLOT0.

* LED Solid Off
(Resume Flash)



BEPLOT1.

LED Solid 1 Second



BEPLOT3.

LED Solid 3 Seconds



BEPLOT5.

LED Solid 5 Seconds

If you have scanned a barcode and don't want to wait for the LED to turn off, press the trigger a second time and the LED turns off. You can then scan the next barcode.

Page Volume Control

Note: *This setting is not supported by the Xenon XP 1950h scanner.*

When you press the page button on the base or Access Point, the scanners associated with that base or Access Point will begin beeping in response. If you press the trigger on a scanner that is beeping in response, or press the page button on the base or Access Point a second time, all associated scanners will stop beeping. The following settings set the paging volume, independent of the volume used when scanning barcodes. *Default = Low.*



BEPPGV0.

Page Volume Off



BEPPGV1.

* Page Volume Low



BEPPGV2.

Page Volume Medium



BEPPGV3.

Page Volume High

Out-of-Range Alarm Volume

Note: This setting is not supported by the Xenon XP 1950h scanner.

If your scanner is out range of the base, an alarm sounds from both your base and scanner. If your scanner is out range of an Access Point, an alarm sounds from just the scanner. The alarm stops when the scanner is moved closer to the base or Access Point, when the base or Access Point connects to another scanner, or when the alarm duration expires (see [Out-of-Range Delay](#) on page 123). The following settings set the Out-of-Range Alarm for the base and the scanner, independent of the volume used when scanning barcodes. *Default = Base Alarm Volume Low, Scanner Alarm Volume Low.*



BASORV0.

Base Alarm Volume
Off



BT_ORV0.

Scanner Alarm Volume
Off



BASORV1.

* Base Alarm Volume
Low



BT_ORV1.

* Scanner Alarm Volume
Low



BASORV2.

Base Alarm Volume
Medium



BASORV3.

Base Alarm Volume
High



BT_ORV2.

Scanner Alarm Volume
Medium



BT_ORV3.

Scanner Alarm Volume
High

Out-of-Range Delay

Note: This setting is not supported by the Xenon XP 1950h scanner.

When using the Out-of-Range Alarm settings, the length of the delay for the alarm is set with an **Out-of-Range Delay**. When the scanner is out of range of the base or Access Point, the alarm will delay for a set length of time before going off. Set the length (in seconds) for a timeout by scanning the following barcode, then setting the timeout (from 0-3,000 seconds) by scanning digits from the [Programming Chart](#), beginning on page 311, then **Save**. *Default = No Delay.*



BT_ORY.

Out-of-Range Delay

Prefix/Suffix Overview

When a barcode is scanned, additional information is sent to the host computer along with the barcode data. This group of barcode data and additional, user-defined data is called a “message string.” The selections in this section are used to build the user-defined data into the message string.

Prefix and Suffix characters are data characters that can be sent before and after scanned data. You can specify if they should be sent with all symbologies, or only with specific symbologies. The following illustration shows the breakdown of a message string:

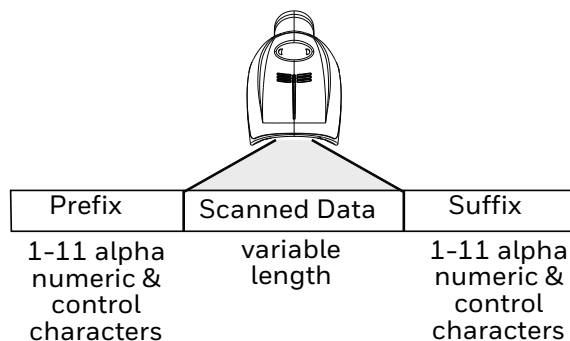

Points to Keep In Mind

- It is not necessary to build a message string. The selections in this chapter are only used if you wish to alter the default settings. *Default prefix = None. Default suffix = None.*
- A prefix or suffix may be added or cleared from one symbology or all symbologies.
- You can add any prefix or suffix from the [ASCII Conversion Chart \(Code Page 1252\)](#), beginning on page 300, plus Code I.D. and AIM I.D.
- You can string together several entries for several symbologies at one time.

- Enter prefixes and suffixes in the order in which you want them to appear on the output.
- When setting up for specific symbologies (as opposed to all symbologies), the specific symbology ID value counts as an added prefix or suffix character.
- The maximum size of a prefix or suffix configuration is 200 characters, which includes header information.

Add a Prefix or Suffix:

- Step 1. Scan the **Add Prefix** or **Add Suffix** symbol ([page 127](#)).
- Step 2. Determine the 2 digit hex value from the [Symbology Charts](#) (beginning on page 297) for the symbology to which you want to apply the prefix or suffix. For example, for Code 128, Code ID is “j” and Hex ID is “6A”.
- Step 3. Scan the 2 hex digits from the [Programming Chart](#), beginning on page 311, or scan **9, 9** for all symbologies.

To add the Code I.D., scan **5, C, 8, 0**.

To add the AIM I.D., scan **5, C, 8, 1**.

To add the serial number, scan **5, C, 8, 8**.

To add a backslash (\), scan **5, C, 5, C**.

Note: *When adding a backslash (\), you must scan 5C twice – once to create the leading backslash and then to create the backslash itself.*

Step 4. Repeat Steps 2 and 3 for every prefix or suffix character.

Step 5. Scan **Save** to exit and save, or scan **Discard** to exit without saving.

Repeat the steps above to add a prefix or suffix for another symbology.

Example: Add a Tab Suffix to All Symbologies

- Step 1. Scan **Add Suffix**.
- Step 2. Scan **9, 9** from the [Programming Chart](#), beginning on page 311 to apply this suffix to all symbologies.
- Step 3. Scan **0, 9** from the [Programming Chart](#), beginning on page 311. This corresponds with the hex value for a horizontal tab, shown in the [ASCII Conversion Chart \(Code Page 1252\)](#), beginning on page 300.
- Step 4. Scan **Save**, or scan **Discard** to exit without saving.

Clear One or All Prefixes or Suffixes

You can clear a single prefix or suffix, or clear all prefixes/suffixes for a symbology. If you have been entering prefixes and suffixes for single symbologies, you can use **Clear One Prefix (Suffix)** to delete a specific character from a symbology. When you **Clear All Prefixes (Suffixes)**, all the prefixes or suffixes for a symbology are deleted.

- Step 1. Scan the **Clear One Prefix** or **Clear One Suffix** symbol.
- Step 2. Determine the 2 digit hex value from the Symbology Chart (included in the [Symbology Charts](#), beginning on page 297) for the symbology from which you want to clear the prefix or suffix.
- Step 3. Scan the 2 digit hex value from the [Programming Chart](#), beginning on page 311 or scan **9, 9** for all symbologies.

Your change is automatically saved.

Add a Carriage Return Suffix to All Symbologies

Scan the following barcode if you wish to add a carriage return suffix to all symbologies at once. This action first clears all current suffixes, then programs a carriage return suffix for all symbologies.



Prefix Selections

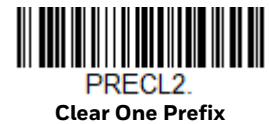

Suffix Selections

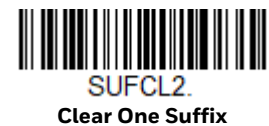



Function Code Transmit

By default, all ASCII control characters are transmitted with barcode data. These non-printable characters are translated into predefined key strokes, or CTRL+X functions (see [ASCII Conversion Chart \(Code Page 1252\)](#), beginning on page 300). If these key strokes interfere with your host's software application, scan **Disable** to keep these ASCII control characters from being transmitted. *Default = Enable.*



Note: You can also use a custom data format (see [Data Format](#) beginning on page 131) to translate these characters into a more meaningful output.

Intercharacter, Interfunction, and Intermesssage Delays

Some terminals drop information (characters) if data comes through too quickly. Intercharacter, interfunction, and intermessage delays slow the transmission of data, increasing data integrity.

Intercharacter Delay

An intercharacter delay of up to 5000 milliseconds (in 5ms increments) may be placed between the transmission of each character of scanned data. Scan the **Intercharacter Delay** barcode below, then scan the number of 5ms delays from the [Programming Chart](#), beginning on page 311, then **Save**.

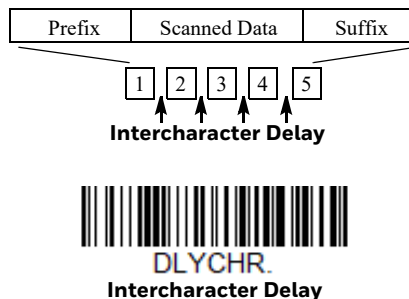

To remove this delay, scan the **Intercharacter Delay** barcode, then set the number of delays to 0. Scan the **Save** barcode from the [Programming Chart](#), beginning on page 311.

Note: *Intercharacter delays are not supported in USB serial emulation.*

User Specified Intercharacter Delay

An intercharacter delay of up to 5000 milliseconds (in 5ms increments) may be placed after the transmission of a particular character of scanned data. Scan the **Delay Length** barcode below, then scan the number of 5ms delays from the [Programming Chart](#), beginning on page 311, then **Save**.

Next, scan the **Character to Trigger Delay** barcode, then the 2-digit hex value for a printable character to trigger the delay (see [Lower ASCII Reference Table](#), page 301.)



To remove this delay, scan the **Delay Length** barcode, and set the number of delays to **0**. Scan the **Save** barcode from the [Programming Chart](#), beginning on page 311.

Interfunction Delay

An interfunction delay of up to 5000 milliseconds (in 5ms increments) may be placed between the transmission of each control character in the message string. Scan the **Interfunction Delay** barcode below, then scan the number of 5ms delays, and the **Save** barcode from the [Programming Chart](#), beginning on page 311.

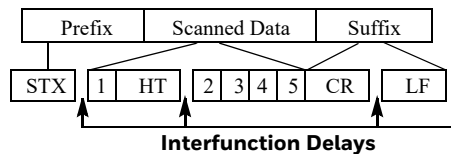

To remove this delay, scan the **Interfunction Delay** barcode, then set the number of delays to 0. Scan the **Save** barcode from the [Programming Chart](#), beginning on page 311.

Intermessage Delay

An intermessage delay of up to 5000 milliseconds (in 5ms increments) may be placed between each scan transmission. Scan the **Intermessage Delay** barcode below, then scan the number of 5ms delays, and the **Save** barcode from the [Programming Chart](#), beginning on page 311.

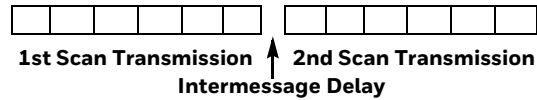

To remove this delay, scan the **Intermessage Delay** barcode, then set the number of delays to **0**. Scan the **Save** barcode from the [Programming Chart](#), beginning on page 311.

Data Format Editor Introduction

You may use the Data Format Editor to change the scanner's output. For example, you can use the Data Format Editor to insert characters at certain points in barcode data as it is scanned. The selections in the following pages are used only if you wish to alter the output. *Default Data Format setting = None.*

Normally, when you scan a barcode, it is output automatically. However, when you create a format, you must use a "send" command (see [Send Commands](#) on page 134) within the format program to output data.

Multiple formats may be programmed into the scanner. They are stacked in the order in which they are entered. However, the following list presents the order in which formats are applied:

1. Specific Terminal ID, Actual Code ID, Actual Length
2. Specific Terminal ID, Actual Code ID, Universal Length
3. Specific Terminal ID, Universal Code ID, Actual Length
4. Specific Terminal ID, Universal Code ID, Universal Length
5. Universal Terminal ID, Actual Code ID, Actual Length
6. Universal Terminal ID, Actual Code ID, Universal Length
7. Universal Terminal ID, Universal Code ID, Actual Length
8. Universal Terminal ID, Universal Code ID, Universal Length

The maximum size of a data format configuration is 2000 bytes, which includes header information.

If a barcode is read that fails the first data format, the next data format, if there is one, will be used on the barcode data. If there is no other data format, the raw data is output.

If you have changed data format settings, and wish to clear all formats and return to the factory defaults, scan the **Default Data Format** code below.



Show Data Format

Scan the barcode below to show current data format settings.



Add a Data Format

- Step 1. Scan the **Enter Data Format** symbol ([page 133](#)).
- Step 2. **Select Primary/Alternate Format**
Determine if this will be your primary data format, or one of 3 alternate formats. This allows you to save a total of 4 different data formats. To program your primary format, scan **0** from the [Programming Chart](#), beginning on page 311. If you are programming an alternate format, scan **1, 2, or 3**, depending on which alternate format you are programming. (See [Primary/Alternate Data Formats](#) on page 149 for further information.)
- Step 3. **Terminal Type**
Refer to [Terminal ID Table](#) (page 134) and locate the Terminal ID number for your PC. Scan three numeric barcodes from the [Programming Chart](#), beginning on page 311, to program the scanner for your terminal ID (you must enter 3 digits). For example, scan **0 0 3** for an AT wedge.

Note: **099** indicates all terminal types.

- Step 4. **Code I.D.**
In the [Symbology Charts](#), beginning on page 297, find the symbology to which you want to apply the data format. Locate the Hex value for that symbology and scan the 2 digit hex value from the [Programming Chart](#), beginning on page 311.

If you wish to create a data format for all symbologies, with the exception of some specific symbologies, refer to B8 ([page 147](#)).

If you are creating a data format for Batch Mode Quantity, use **35** for the Code I.D.

Note: **99** indicates all symbologies.

- Step 5. **Length**
Specify what length (up to 9999 characters) of data will be acceptable for this symbology. Scan the four digit data length from the [Programming](#)

[Chart](#), beginning on page 311. For example, 50 characters is entered as **0050**.

Note: **9999** indicates all lengths.

Step 6. **Editor Commands**

Refer to [Data Format Editor Commands](#) (page 134). Scan the symbols that represent the command you want to enter.

Step 7. Scan **Save** to save your data format, or **Discard** to exit without saving your changes.



Other Programming Selections

- **Clear One Data Format**

This deletes one data format for one symbology. If you are clearing the primary format, scan **0** from the [Programming Chart](#), beginning on page 311. If you are clearing an alternate format, scan **1**, **2**, or **3**, depending on the format you are clearing. Scan the Terminal Type and Code I.D. (see [Symbology Charts](#) on page 297), and the barcode data length for the specific data format that you want to delete. All other formats remain unaffected.

- **Clear all Data Formats**

This clears all data formats.

- **Save**

Exit and save your data format changes.

- **Discard**

Exit without saving any data format changes.





Terminal ID Table

Terminal	Model(s)	Terminal ID
USB	PC keyboard (HID)	124
	Mac Keyboard	125
	PC Keyboard (Japanese)	134
	Serial (COM driver required)	130
	HID POS	131
	USB SurePOS Handheld	128
	USB SurePOS Tabletop	129
	Serial	RS232 TTL
RS232 True		000
RS485 (IBM-HHBCR 1+2, 46xx)		051
Keyboard	PS2 compatibles	003
	AT compatibles	002

Data Format Editor Commands

When working with the Data Format Editor, a virtual cursor is moved along your input data string. The following commands are used to both move this cursor to different positions, and to select, replace, and insert data into the final output.

Send Commands

Send all characters

- F1** Include in the output message all of the characters from the input message, starting from current cursor position, followed by an insert character. *Syntax = F1xx* where xx stands for the insert character's hex value for its ASCII code. Refer to the [ASCII Conversion Chart \(Code Page 1252\)](#), beginning on page 300 for decimal, hex and character codes.

Send a number of characters

F2 Include in the output message a number of characters followed by an insert character. Start from the current cursor position and continue for “nn” characters or through the last character in the input message, followed by character “xx.” Syntax = *F2nnxx* where nn stands for the numeric value (00-99) for the number of characters, and xx stands for the insert character’s hex value for its ASCII code. Refer to the [ASCII Conversion Chart \(Code Page 1252\)](#), beginning on page 300 for decimal, hex and character codes.

F2 Example: Send a number of characters



Send the first 10 characters from the barcode above, followed by a carriage return.
Command string: F2100D

F2 is the “Send a number of characters” command

10 is the number of characters to send

0D is the hex value for a CR

The data is output as: **1234567890**

F2 and F1 Example: Split characters into 2 lines

Send the first 10 characters from the barcode above, followed by a carriage return, followed by the rest of the characters.

Command string: **F2100DF10D**

F2 is the “Send a number of characters” command

10 is the number of characters to send for the first line

0D is the hex value for a CR

F1 is the “Send all characters” command

0D is the hex value for a CR

The data is output as:

1234567890
ABCDEFGHIJ
<CR>

Send all characters up to a particular character

F3 Include in the output message all characters from the input message, starting with the character at the current cursor position and continuing to, but not including, the search character “ss,” followed by an insert character. The cursor is moved forward to the “ss” character. *Syntax = F3ssxx* where ss stands for the search character’s hex value for its ASCII code, and xx stands for the insert character’s hex value for its ASCII code.

Refer to the [ASCII Conversion Chart \(Code Page 1252\)](#), beginning on page 300 for decimal, hex and character codes.

F3 Example: Send all characters up to a particular character



Using the barcode above, send all characters up to but not including “D,” followed by a carriage return.

Command string: **F3440D**

F3 is the “Send all characters up to a particular character” command

44 is the hex value for a 'D’

0D is the hex value for a CR

The data is output as:

**1234567890ABC
<CR>**

Send all characters up to a string

B9 Include in the output message all characters from the input message, starting with the character at the current cursor position and continuing to, but not including, the search string “s...s.” The cursor is moved forward to the beginning of the “s...s” string. *Syntax = B9nnns...s* where nnnn stands for the length of the string, and s...s stands for the string to be matched. The string is made up of hex values for the characters in the string. Refer to the [ASCII Conversion Chart \(Code Page 1252\)](#), beginning on page 300 for decimal, hex and character codes.

B9 Example: Send all characters up to a defined string



Using the barcode above, send all characters up to but not including “AB.”

Command string: **B90024142**

B9 is the “Send all characters up to a string” command

0002 is the length of the string (2 characters)

41 is the hex value for A

42 is the hex value for B

The data is output as: **1234567890**

Send all but the last characters

E9 Include in the output message all but the last “nn” characters, starting from the current cursor position. The cursor is moved forward to one position past the last input message character included. *Syntax = E9nn* where nn stands for the numeric value (00-99) for the number of characters that will not be sent at the end of the message.

Insert a character multiple times

F4 Send “xx” character “nn” times in the output message, leaving the cursor in the current position. *Syntax = F4xxnn* where xx stands for the insert character’s hex value for its ASCII code, and nn is the numeric value (00-99) for the number of times it should be sent. Refer to the [ASCII Conversion Chart \(Code Page 1252\)](#), beginning on page 300 for decimal, hex and character codes.

E9 and F4 Example: Send all but the last characters, followed by 2 tabs



Send all characters except for the last 8 from the barcode above, followed by 2 tabs.

Command string: **E908F40902**

E9 is the “Send all but the last characters” command

08 is the number of characters at the end to ignore

F4 is the “Insert a character multiple times” command

09 is the hex value for a horizontal tab

02 is the number of times the tab character is sent

The data is output as: **1234567890AB <tab><tab>**

Insert a string

BA Send “ss” string of “nn” length in the output message, leaving the cursor in the current position. *Syntax = BAnnnns...s* where nnnn stands for the length of the string, and s...s stands for the string. The string is made up of hex values for the characters in the string. Refer to the [ASCII Conversion Chart \(Code Page 1252\)](#), beginning on page 300 for decimal, hex and character codes.

B9 and BA Example: Look for the string “AB” and insert 2 asterisks ()**



Using the barcode above, send all characters up to but not including “AB.” Insert 2 asterisks at that point, and send the rest of the data with a carriage return after.

Command string: **B900024142BA00022A2AF10D**

B9 is the “Send all characters up to a string” command

0002 is the length of the string (2 characters)

41 is the hex value for A

42 is the hex value for B

BA is the “Insert a string” command

0002 is the length of the string to be added (2 characters)

2A is the hex value for an asterisk (*)

2A is the hex value for an asterisk (*)

F1 is the “Send all characters” command

0D is the hex value for a CR

The data is output as:

1234567890ABCDEFGHIJ**
<CR>

Insert symbology name

- B3** Insert the name of the barcode’s symbology in the output message, without moving the cursor. Only symbologies with a Honeywell ID are included (see [Symbology Charts](#) on page 297). Refer to the [ASCII Conversion Chart \(Code Page 1252\)](#), beginning on page 300 for decimal, hex and character codes.

Insert barcode length

- B4** Insert the barcode’s length in the output message, without moving the cursor. The length is expressed as a numeric string and does not include leading zeros.

B3 and B4 Example: Insert the symbology name and length



Send the symbology name and length before the barcode data from the barcode above. Break up these insertions with spaces. End with a carriage return.

Command string: **B3F42001B4F42001F10D**

B3 is the “Insert symbology name” command
 F4 is the “Insert a character multiple times” command
 20 is the hex value for a space
 01 is the number of times the space character is sent
 B4 is the “Insert barcode length” command
 F4 is the “Insert a character multiple times” command
 20 is the hex value for a space
 01 is the number of times the space character is sent
 F1 is the “Send all characters” command
 0D is the hex value for a CR

The data is output as:
Code128 20 1234567890ABCDEFGHIJ
<CR>

Insert key strokes

B5 Insert a key stroke or combination of key strokes. Key strokes are dependent on your keyboard (see [Keyboard Key References](#) on page 307). Any key can be inserted, including arrows and functions. *Syntax* = 5CB5xxssnn where xx is the number of keys pressed (without key modifiers), ss is the key modifier from the table below, and nn is the key number from the [Keyboard Key References](#), page 307.

Key Modifiers	Hex
No Key Modifier	00
Shift Left	01
Shift Right	02
Alt Left	04
Alt Right	08
Control Left	10
Control Right	20

For example, B501021F inserts an “A” on a 104 key, U.S. style keyboard. B5 = the command, 01 = number of key press events (without the key modifier), 02 is the key modifier for Shift Right, and 1F is the “a” key. If a lower case “a” were to be inserted, B501001F would be entered.

If there are three keystrokes, the syntax would change from B5xxssnn for one keystroke to B5xxssnnssnnssnn. An example that would insert "abc" is as follows: B503001F00320030F833.

Note: Key modifiers can be added together when needed. The sum is converted to hexadecimals.

Example: Control Left+Shift Left = 17, converted to hexadecimal = 11.

Move Commands

Move the cursor forward a number of characters

F5 Move the cursor ahead “nn” characters from current cursor position.
Syntax = F5nn where nn is the numeric value (00-99) for the number of characters the cursor should be moved ahead.

F5 Example: Move the cursor forward and send the data



Move the cursor forward 3 characters, then send the rest of the barcode data from the barcode above. End with a carriage return.

Command string: **F503F10D**

F5 is the “Move the cursor forward a number of characters” command

03 is the number of characters to move the cursor

F1 is the “Send all characters” command

0D is the hex value for a CR

The data is output as:

4567890ABCDEFGHIJ
<CR>

Move the cursor backward a number of characters

F6 Move the cursor back “nn” characters from current cursor position.
Syntax = F6nn where nn is the numeric value (00-99) for the number of characters the cursor should be moved back.

Move the cursor to the beginning

F7 Move the cursor to the first character in the input message. Syntax = F7.

FE and F7 Example: Manipulate barcodes that begin with a 1



Search for barcodes that begin with a 1. If a barcode matches, move the cursor back to the beginning of the data and send 6 characters followed by a carriage return. Using the barcode above:

Command string: **FE31F7F2060D**

FE is the “Compare characters” command

31 is the hex value for 1

F7 is the “Move the cursor to the beginning” command

F2 is the “Send a number of characters” command

06 is the number of characters to send

0D is the hex value for a CR

The data is output as:

123456

<CR>

Move the cursor to the end

EA Move the cursor to the last character in the input message. *Syntax = EA.*

Search Commands

Search forward for a character

F8 Search the input message forward for “xx” character from the current cursor position, leaving the cursor pointing to the “xx” character. *Syntax = F8xx* where xx stands for the search character’s hex value for its ASCII code. Refer to the [ASCII Conversion Chart \(Code Page 1252\)](#), beginning on page 300 for decimal, hex and character codes.

F8 Example: Send barcode data that starts after a particular character



Search for the letter “D” in barcodes and send all the data that follows, including the “D.” Using the barcode above:

Command string: **F844F10D**

F8 is the “Search forward for a character” command

44 is the hex value for “D”

F1 is the “Send all characters” command

0D is the hex value for a CR

The data is output as:

DEFGHIJ
<CR>

Search backward for a character

- F9** Search the input message backward for “xx” character from the current cursor position, leaving the cursor pointing to the “xx” character. *Syntax = F9xx* where xx stands for the search character’s hex value for its ASCII code. Refer to the [ASCII Conversion Chart \(Code Page 1252\)](#), beginning on page 300 for decimal, hex and character codes.

Search forward for a string

- B0** Search forward for “s” string from the current cursor position, leaving cursor pointing to “s” string. *Syntax = B0nnnnS* where nnnn is the string length (up to 9999), and S consists of the ASCII hex value of each character in the match string. For example, B0000454657374 will search forward for the first occurrence of the 4 character string “Test.” Refer to the [ASCII Conversion Chart \(Code Page 1252\)](#), beginning on page 300 for decimal, hex and character codes.

B0 Example: Send barcode data that starts after a string of characters



Search for the letters “FGH” in barcodes and send all the data that follows, including “FGH.” Using the barcode above:

Command string: **B00003464748F10D**

B0 is the “Search forward for a string” command

0003 is the string length (3 characters)

46 is the hex value for “F”

47 is the hex value for “G”

48 is the hex value for “H”

F1 is the “Send all characters” command

0D is the hex value for a CR

The data is output as:

FGHIJ
<CR>

Search backward for a string

B1 Search backward for “s” string from the current cursor position, leaving cursor pointing to “s” string. Syntax = B1nnnnS where nnnn is the string length (up to 9999), and S consists of the ASCII hex value of each character in the match string. For example, B1000454657374 will search backward for the first occurrence of the 4 character string “Test.”

Refer to the [ASCII Conversion Chart \(Code Page 1252\)](#), beginning on page 300 for decimal, hex and character codes.

Search forward for a non-matching character

E6 Search the input message forward for the first non-“xx” character from the current cursor position, leaving the cursor pointing to the non-“xx” character. Syntax = E6xx where xx stands for the search character’s hex value for its ASCII code. Refer to the [ASCII Conversion Chart \(Code Page 1252\)](#), beginning on page 300 for decimal, hex and character codes.

E6 Example: Remove zeros at the beginning of barcode data



This example shows a barcode that has been zero filled. You may want to ignore the zeros and send all the data that follows. E6 searches forward for the first character that is not zero, then sends all the data after, followed by a carriage return. Using the barcode above:

Command string: **E630F10D**

E6 is the “Search forward for a non-matching character” command

30 is the hex value for 0

F1 is the “Send all characters” command

0D is the hex value for a CR

The data is output as:

37692

<CR>

Search backward for a non-matching character

E7 Search the input message backward for the first non-“xx” character from the current cursor position, leaving the cursor pointing to the non-“xx” character. Syntax = E7xx where xx stands for the search character’s hex value for its ASCII code. Refer to the [ASCII Conversion Chart \(Code Page 1252\)](#), beginning on page 300 for decimal, hex and character codes.

Miscellaneous Commands

Suppress characters

FB Suppress all occurrences of up to 15 different characters, starting at the current cursor position, as the cursor is advanced by other commands. When the FC command is encountered, the suppress function is terminated. The cursor is not moved by the FB command.

Syntax = FBnnxxyy ..zz where nn is a count of the number of suppressed characters in the list, and xxyy ..zz is the list of characters to be suppressed.

FB Example: Remove spaces in barcode data



This example shows a barcode that has spaces in the data. You may want to remove the spaces before sending the data. Using the barcode above:

Command string: **FB0120F10D**

FB is the “Suppress characters” command

01 is the number of character types to be suppressed

20 is the hex value for a space

F1 is the “Send all characters” command

0D is the hex value for a CR

The data is output as:

34567890

<CR>

Stop suppressing characters

FC Disables suppress filter and clear all suppressed characters. Syntax = FC.

Replace characters

E4 Replaces up to 15 characters in the output message, without moving the cursor. Replacement continues until the E5 command is encountered. Syntax = E4nnxx₁xx₂yy₁yy₂...zz₁zz₂ where nn is the total count of the number of characters in the list (characters to be replaced plus replacement characters); xx₁ defines characters to be replaced and xx₂ defines replacement characters, continuing through zz₁ and zz₂.

E4 Example: Replace zeros with CRs in barcode data



If the barcode has characters that the host application does not want included, you can use the E4 command to replace those characters with something else. In this example, you will replace the zeros in the barcode above with carriage returns.

Command string: **E402300DF10D**

E4 is the “Replace characters” command

02 is the total count of characters to be replaced, plus the replacement characters (0 is replaced by CR, so total characters = 2)

30 is the hex value for 0

0D is the hex value for a CR (the character that will replace the 0)

F1 is the “Send all characters” command

0D is the hex value for a CR

The data is output as:

1234

5678

ABC

<CR>

Stop replacing characters

E5 Terminates character replacement. *Syntax = E5.*

Compare characters

FE Compare the character in the current cursor position to the character “xx.” If characters are equal, move the cursor forward one position. *Syntax = FExx* where xx stands for the comparison character’s hex value for its ASCII code.

Refer to the [ASCII Conversion Chart \(Code Page 1252\)](#), beginning on page 300 for decimal, hex and character codes.

Compare string

B2 Compare the string in the input message to the string “s.” If the strings are equal, move the cursor forward past the end of the string. *Syntax = B2nnnnS* where nnnn is the string length (up to 9999), and S consists of the ASCII hex value of each character in the match string. For example, B2000454657374 will compare the string at the current cursor position with the 4 character string “Test.”

Refer to the [ASCII Conversion Chart \(Code Page 1252\)](#), beginning on page 300 for decimal, hex and character codes.

Check for a number

EC Check to make sure there is an ASCII number at the current cursor position. The format is aborted if the character is not numeric.

EC Example: Only output the data if the barcode begins with a number

If you want only data from barcodes that begin with a number, you can use EC to check for the number.

Command string: **ECF10D**

EC is the “Check for a number” command

F1 is the “Send all characters” command

0D is the hex value for a CR

If this barcode is read,  the next data format, if there is one, will be used on the data. If there is no other format, the format fails and the raw data is output as **AB1234**.

If this barcode is read:  the data is output as:

1234AB
<CR>

Check for non-numeric character

ED Check to make sure there is a non-numeric ASCII character at the current cursor position. The format is aborted if the character is numeric.

ED Example: Only output the data if the barcode begins with a letter

If you want only data from barcodes that begin with a letter, you can use ED to check for the letter.

Command string: **EDF10D**

ED is the “Check for a non-numeric character” command

F1 is the “Send all characters” command

0D is the hex value for a CR

If this barcode is read,  the next data format, if there is one, will be used on this data. If there is no other format, the format fails and the raw data is output as **1234AB**.

If this barcode is read:  the data is output as:

AB1234
<CR>

Insert a delay

EF Inserts a delay of up to 49,995 milliseconds (in multiples of 5), starting from the current cursor position. Syntax = EFnnnn where nnnn stands for the delay in 5ms increments, up to 9999. This command can only be used with keyboard emulation.

Discard Data

B8 Discards types of data. For example, you may want to discard Code 128 barcodes that begin with the letter A. In step 4 ([page 132](#)), select 6A (for Code 128), and in step 5, select 9999 (for all lengths). Enter FE41B8 to compare and discard Code 128 barcodes that begin with the letter A. Syntax = B8.

Note: The B8 command must be entered after all other commands.

The Data Format must be **Required** (see [page 147](#)) in order for the B8 command to work.

If Data Format is On, but Not Required ([page 148](#)), barcode data that meets the B8 format is scanned and output as usual.

Because the data format needs to be **On** and **Required** ([page 148](#)) for the B8 command, you must input data formats for all barcodes you wish to discard as well as all barcodes you wish to output.

Other data format settings impact the B8 command. If Data Format Non-Match Error Tone is On ([page 148](#)), the scanner emits an error tone. If Data format Non-Match Error Tone is Off, the code is disabled for reading and no tone is sounded.

Data Formatter

When Data Formatter is turned Off, the barcode data is output to the host as read, including prefixes and suffixes.



You may wish to require the data to conform to a data format you have created and saved. The following settings can be applied to your data format:

- **Data Formatter On, Not Required, Keep Prefix/Suffix**
Scanned data is modified according to your data format, and prefixes and suffixes are transmitted.
- **Data Formatter On, Not Required, Drop Prefix/Suffix**
Scanned data is modified according to your data format. If a data format is found for a particular symbol, those prefixes and suffixes are not transmitted. If a data format is *not* found for that symbol, the prefixes and suffixes are transmitted.
- **Data Format Required, Keep Prefix/Suffix**
Scanned data is modified according to your data format, and prefixes and suffixes are transmitted. Any data that does not match your data format

requirements generates an error tone and the data in that barcode is not transmitted. If you wish to process this type of barcode without generating an error tone, see [Data Format Non-Match Error Tone](#).

- **Data Format Required, Drop Prefix/Suffix**
Scanned data is modified according to your data format. If a data format is found for a particular symbol, those prefixes and suffixes are not transmitted. Any data that does not match your data format requirements generates an error tone. If you wish to process this type of barcode without generating an error tone, see [Data Format Non-Match Error Tone](#).

Choose one of the following options. *Default = Data Formatter On, Not Required, Keep Prefix/Suffix.*



DFM_EN1.

* Data Formatter On,
Not Required,
Keep Prefix/Suffix



DFM_EN3.

Data Formatter On,
Not Required,
Drop Prefix/Suffix



DFM_EN2.

Data Format Required,
Keep Prefix/Suffix



DFM_EN4.

Data Format Required,
Drop Prefix/Suffix

Data Format Non-Match Error Tone

When a barcode is encountered that doesn't match your required data format, the scanner normally generates an error tone. However, you may want to continue scanning barcodes without hearing the error tone. If you scan the **Data Format Non-Match Error Tone Off** barcode, data that doesn't conform to your data format is not transmitted, and no error tone will sound. If you wish to hear the error tone when a non-matching barcode is found, scan the **Data Format Non-Match Error Tone On** barcode. *Default = Data Format Non-Match Error Tone On.*



DFMDEC0.

* Data Format Non-Match Error
Tone On



Primary/Alternate Data Formats

You can save up to four data formats, and switch between these formats. Your primary data format is saved under **0**. Your other three formats are saved under **1**, **2**, and **3**. To set your device to use one of these formats, scan one of the barcodes below.



Single Scan Data Format Change

You can also switch between data formats for a single scan. The next barcode is scanned using an alternate data format, then reverts to the format you have selected above (either Primary, 1, 2, or 3).

For example, you may have set your device to the data format you saved as Data Format 3. You can switch to Data Format 1 for a single trigger pull by scanning the **Single Scan-Data Format 1** barcode below. The next barcode that is scanned uses Data Format 1, then reverts back to Data Format 3.





VSAF_2.

Single Scan-Data Format 2



VSAF_1.

Single Scan-Data Format 1



VSAF_3.

Single Scan-Data Format 3

SYMBOLOLOGIES

This programming section contains the following menu selections. Refer to [Chapter 11](#) for settings and defaults.

- All Symbolologies
- Aztec Code
- China Post (Hong Kong 2 of 5)
- Chinese Sensible (Han Xin) Code
- Codabar
- Codablock A
- Codablock F
- Code 11
- Code 128
- Code 32 Pharmaceutical (PARAF)
- Code 39
- Code 93
- Data Matrix
- Digimarc Barcode™
- DotCode
- EAN/JAN-13
- EAN/JAN-8
- GS1 Composite Codes
- GS1 DataBar Expanded
- GS1 DataBar Limited
- GS1 DataBar Omnidirectional
- GS1 Emulation
- GS1-128
- Interleaved 2 of 5
- Korea Post
- Label Code
- Matrix 2 of 5
- MaxiCode
- MicroPDF417
- MSI
- NEC 2 of 5
- Postal Codes - 2D
- Postal Codes - Linear
- PDF417
- QR Code
- Straight 2 of 5 IATA (two-bar start/stop)
- Straight 2 of 5 Industrial (three-bar start/stop)
- TCIF Linked Code 39 (TLC39)
- Telepen
- Trioptic Code
- UPC-A
- UPC-A/EAN-13 with Extended Coupon Code
- UPC-E0
- UPC-E1

All Symbologies

For best scanner performance, you should only enable the symbologies that you need. Scan **All Symbologies Off** to disable all symbologies, then enable the symbologies you need by scanning the **On** barcode for each symbology.



Message Length Description

You are able to set the valid reading length of some of the barcode symbologies. You may wish to set the same value for minimum and maximum length to force the scanner to read fixed length barcode data. This helps reduce the chances of a misread.

Example: Decode only those barcodes with a count of 9-20 characters.
Min. length = 09
Max. length = 20

Example: Decode only those barcodes with a count of 15 characters.
Min. length = 15
Max. length = 15

For a value other than the minimum and maximum message length defaults, scan the barcodes included in the explanation of the symbology, then scan the digit value of the message length and **Save** barcodes from the [Programming Chart](#), beginning on page 311. The minimum and maximum lengths and the defaults are included with the respective symbologies.

Codabar

<Default All Codabar Settings>



Codabar On/Off

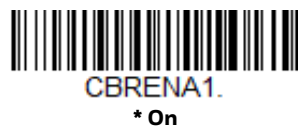



Codabar Start / Stop Characters

Start/Stop characters identify the leading and trailing ends of the barcode. You may either transmit, or not transmit Start/Stop characters. *Default = Don't Transmit.*



Codabar Check Character

Codabar check characters are created using different “modulos.” You can program the scanner to read only Codabar barcodes with Modulo 16 check characters. *Default = No Check Character.*

No Check Character indicates that the scanner reads and transmits barcode data with or without a check character.

When Check Character is set to **Validate and Transmit**, the scanner will only read Codabar barcodes printed with a check character, and will transmit this character at the end of the scanned data.

When Check Character is set to **Validate, but Don't Transmit**, the unit will only read Codabar barcodes printed *with* a check character, but will not transmit the check character with the scanned data.



Codabar Concatenation

Codabar supports symbol concatenation. When you enable concatenation, the scanner looks for a Codabar symbol having a “D” start character, adjacent to a symbol having a “D” stop character. In this case the two messages are concatenated into one with the “D” characters omitted.



Select **Require** to prevent the scanner from decoding a single “D” Codabar symbol without its companion. This selection has no effect on Codabar symbols without Stop/Start D characters.



Codabar Message Length

Scan the barcodes below to change the message length. Refer to [Message Length Description](#) (page 152) for additional information. Minimum and Maximum lengths = 2-60. Minimum Default = 4, Maximum Default = 60.



Code 39

< Default All Code 39 Settings >



Code 39 On/Off



If you are reading Code 39 barcodes, Codablock A should remain disabled. If you are enabling Codablock A (see [Codablock A](#) on page 191), you should disable Code 39.

Code 39 Start/Stop Characters

Start/Stop characters identify the leading and trailing ends of the barcode. You may either transmit, or not transmit Start/Stop characters. *Default = Don't Transmit.*



Code 39 Check Character

No Check Character indicates that the scanner reads and transmits barcode data with or without a check character.

When Check Character is set to **Validate, but Don't Transmit**, the unit only reads Code 39 barcodes printed with a check character, but will not transmit the check character with the scanned data.

When Check Character is set to **Validate and Transmit**, the scanner only reads Code 39 barcodes printed with a check character, and will transmit this character at the end of the scanned data. *Default = No Check Character.*



Code 39 Message Length

Scan the barcodes below to change the message length. Refer to [Message Length Description](#) (page 152) for additional information. Minimum and Maximum lengths = 0-48. Minimum Default = 0, Maximum Default = 48.



Code 39 Append

This function allows the scanner to append the data from several Code 39 barcodes together before transmitting them to the host computer. When the scanner encounters a Code 39 barcode with the append trigger character(s), it buffers Code 39 barcodes until it reads a Code 39 barcode that does not have the append trigger. The data is then transmitted in the order in which the barcodes were read (FIFO). *Default = Off.*



Code 32 Pharmaceutical (PARAF)

Code 32 Pharmaceutical is a form of the Code 39 symbology used by Italian pharmacies. This symbology is also known as PARAF.

Note: *Trioptic Code (page 191) must be turned off while scanning Code 32 Pharmaceutical codes.*



Full ASCII

If Full ASCII Code 39 decoding is enabled, certain character pairs within the barcode symbol will be interpreted as a single character. For example: \$V will be decoded as the ASCII character SYN, and /C will be decoded as the ASCII character #. *Default = Off.*

Full ASCII Table											
NUL %U	DLE \$P	SP SPACE	0 0	@ %V	P P	' %W	p +P				
SOH \$A	DC1 \$Q	! /A	1 1	A A	Q Q	a +A	q +Q				
STX \$B	DC2 \$R	" /B	2 2	B B	R R	b +B	r +R				
ETX \$C	DC3 \$S	# /C	3 3	C C	S S	c +C	s +S				
EOT \$D	DC4 \$T	\$ /D	4 4	D D	T T	d +D	t +T				
ENQ \$E	NAK \$U	% /E	5 5	E E	U U	e +E	u +U				
ACK \$F	SYN \$V	& /F	6 6	F F	V V	f +F	v +V				
BEL \$G	ETB \$W	' /G	7 7	G G	W W	g +G	w +W				
BS \$H	CAN \$X	(/H	8 8	H H	X X	h +H	x +X				
HT \$I	EM \$Y) /I	9 9	I I	Y Y	i +I	y +Y				
LF \$J	SUB \$Z	* /J	: /Z	J J	Z Z	j +J	z +Z				
VT \$K	ESC %A	+ /K	; %F	K K	[%K	k +K	{ %P				
FF \$L	FS %B	, /L	< %G	L L	\ %L	l +L	%Q				
CR \$M	GS %C	- /M	= %H	M M] %M	m +M	} %R				
SO \$N	RS %D	. /N	> %I	N N	^ %N	n +N	~ %S				
SI \$O	US %E	/ /O	? %J	O O	_ %O	o +O	DEL %T				

Character pairs /M and /N decode as a minus sign and period respectively.
Character pairs /P through /Y decode as 0 through 9.





Code 39 Code Page

Code pages define the mapping of character codes to characters. If the data received does not display with the proper characters, it may be because the barcode being scanned was created using a code page that is different from the one the host program is expecting. If this is the case, scan the barcode below, select the code page with which the barcodes were created (see [ISO 2022/ISO 646 Character Replacements](#) on page 304), and scan the value and the **Save** barcode from the [Programming Chart](#), beginning on page 311. The data characters should then appear properly.



Interleaved 2 of 5

< Default All Interleaved 2 of 5 Settings >



Interleaved 2 of 5 On/Off



Check Digit

No Check Digit indicates that the scanner reads and transmits barcode data with or without a check digit.

When Check Digit is set to **Validate, but Don't Transmit**, the unit only reads Interleaved 2 of 5 barcodes printed with a check digit, but will not transmit the check digit with the scanned data.

When Check Digit is set to **Validate and Transmit**, the scanner only reads Interleaved 2 of 5 barcodes printed with a check digit, and will transmit this digit at the end of the scanned data. *Default = No Check Digit.*



Interleaved 2 of 5 Message Length

Scan the barcodes below to change the message length. Refer to [Message Length Description](#) (page 152) for additional information. Minimum and Maximum lengths = 2-80. Minimum Default = 6, Maximum Default = 80.



FEBRABAN Decode

Scan the barcodes below to turn FEBRABAN Boleto decoding on or off. *Default = Off.*



NEC 2 of 5

< Default All NEC 2 of 5 Settings >



NEC 2 of 5 On/Off



Check Digit

No Check Digit indicates that the scanner reads and transmits barcode data with or without a check digit.

When Check Digit is set to **Validate, but Don't Transmit**, the unit only reads NEC 2 of 5 barcodes printed with a check digit, but will not transmit the check digit with the scanned data.

When Check Digit is set to **Validate and Transmit**, the scanner only reads NEC 2 of 5 barcodes printed with a check digit, and will transmit this digit at the end of the scanned data. *Default = No Check Digit.*



NEC 2 of 5 Message Length

Scan the barcodes below to change the message length. Refer to [Message Length Description](#) (page 152) for additional information. Minimum and Maximum lengths = 2-80. Minimum Default = 4, Maximum Default = 80.



Code 93

< Default All Code 93 Settings >



Code 93 On/Off



Code 93 Message Length

Scan the barcodes below to change the message length. Refer to [Message Length Description](#) (page 152) for additional information. Minimum and Maximum lengths = 0-80. Minimum Default = 0, Maximum Default = 80.



Code 93 Append

This function allows the scanner to append the data from several Code 93 barcodes together before transmitting them to the host computer. When this function is enabled, the scanner stores those Code 93 barcodes that start with a space (excluding the start and stop symbols), and does not immediately transmit the data. The scanner stores the data in the order in which the barcodes are read, deleting the first space from each. The scanner transmits the appended data when it reads a Code 93 barcode that starts with a character other than a space. *Default = Off.*



C93APP1.

On



C93APP0.

* Off

Code 93 Code Page

Code pages define the mapping of character codes to characters. If the data received does not display with the proper characters, it may be because the barcode being scanned was created using a code page that is different from the one the host program is expecting. If this is the case, scan the barcode below, select the code page with which the barcodes were created (see [ISO 2022/ISO 646 Character Replacements](#) on page 304), and scan the value and the **Save** barcode from the [Programming Chart](#), beginning on page 311. The data characters should then appear properly.



C93DCP.

Code 93 Code Page

Straight 2 of 5 Industrial (three-bar start/stop)

<Default All Straight 2 of 5 Industrial Settings>



R25DFT.

Straight 2 of 5 Industrial On/Off



R25ENA1.

On



R25ENA0.

* Off

Straight 2 of 5 Industrial Message Length

Scan the barcodes below to change the message length. Refer to [Message Length Description](#) (page 152) for additional information. Minimum and Maximum lengths = 1-48. Minimum Default = 4, Maximum Default = 48.



R25MIN.

Minimum Message Length



R25MAX.

Maximum Message Length

Straight 2 of 5 IATA (two-bar start/stop)

<Default All Straight 2 of 5 IATA Settings>



Straight 2 of 5 IATA On/Off



Straight 2 of 5 IATA Redundancy

If you are encountering errors when reading Straight 2 of 5 IATA barcodes, you may want to adjust the redundancy count. Redundancy adjusts the number of times a barcode is decoded before transmission, which may reduce the number of errors. Note that the higher the redundancy count, the longer it will take to decode the barcode. To adjust the redundancy, scan the Straight 2 of 5 IATA Redundancy barcode below, then scan a redundancy count between 0 and 10 on the [Programming Chart](#), beginning on page 311. Then scan the **Save** barcode. *Default = 0.*



Straight 2 of 5 IATA Message Length

Scan the barcodes below to change the message length. Refer to [Message Length Description](#) (page 152) for additional information. Minimum and Maximum lengths = 1-48. Minimum Default = 4, Maximum Default = 48.





Matrix 2 of 5

<Default All Matrix 2 of 5 Settings>



Matrix 2 of 5 On/Off



Matrix 2 of 5 Message Length

Scan the barcodes below to change the message length. Refer to [Message Length Description](#) (page 152) for additional information. Minimum and Maximum lengths = 1-80. Minimum Default = 4, Maximum Default = 80.



Code 11

<Default All Code 11 Settings>



Code 11 On/Off



Check Digits Required

This option sets whether 1 or 2 check digits are required with Code 11 barcodes.
Default = Two Check Digits.



Code 11 Message Length

Scan the barcodes below to change the message length. Refer to [Message Length Description](#) (page 152) for additional information. Minimum and Maximum lengths = 1-80. Minimum Default = 4, Maximum Default = 80.



Code 128

<Default All Code 128 Settings>



Code 128 On/Off



If you are reading Code 128 barcodes, Codablock F should remain disabled. If you are enabling Codablock F (see [Codablock F](#) on page 192), you should disable Code 128.

ISBT 128 Concatenation

In 1994 the International Society of Blood Transfusion (ISBT) ratified a standard for communicating critical blood information in a uniform manner. The use of ISBT formats requires a paid license. The ISBT 128 Application Specification describes 1) the critical data elements for labeling blood products, 2) the current recommendation to use Code 128 due to its high degree of security and its space-efficient design, 3) a variation of Code 128 that supports concatenation of neighboring symbols, and 4) the standard layout for barcodes on a blood product label. Use the barcodes below to turn concatenation on or off. *Default =Off.*



Code 128 Redundancy

If you are encountering errors when reading Code 128 barcodes, you may want to adjust the redundancy count. Redundancy adjusts the number of times a barcode is decoded before transmission, which may reduce the number of errors. Note that

the higher the redundancy count, the longer it will take to decode the barcode. To adjust the redundancy, scan the Code 128 Redundancy barcode below, then scan a redundancy count between 0 and 10 on the [Programming Chart](#), beginning on page 311. Then scan the **Save** barcode. *Default = 0.*



128VOT.

Code 128 Redundancy

Code 128 Message Length

Scan the barcodes below to change the message length. Refer to [Message Length Description](#) (page 152) for additional information. Minimum and Maximum lengths = 0-80. Minimum Default = 0, Maximum Default = 80.



128MIN.

Minimum Message Length



128MAX.

Maximum Message Length

Code 128 Append

This function allows the scanner to append the data from several Code 128 barcodes together before transmitting them to the host computer. When the scanner encounters a Code 128 barcode with the append trigger character(s), it buffers Code 128 barcodes until it reads a Code 128 barcode that does not have the append trigger. The data is then transmitted in the order in which the barcodes were read (FIFO). *Default = Off.*



128APP1.

On



128APP0.

*** Off**

Code 128 Code Page

Code pages define the mapping of character codes to characters. If the data received does not display with the proper characters, it may be because the barcode being scanned was created using a code page that is different from the one the host program is expecting. If this is the case, scan the barcode below, select the code page with which the barcodes were created (see [ISO 2022/ISO 646](#)

Character Replacements on page 304), and scan the value and the **Save** barcode from the [Programming Chart](#), beginning on page 311. The data characters should then appear properly.



GS1-128

<Default All GS1-128 Settings>



GS1-128 On/Off



GS1-128 Message Length

Scan the barcodes below to change the message length. Refer to [Message Length Description](#) (page 152) for additional information. Minimum and Maximum lengths = 1-80. Minimum Default = 1, Maximum Default = 80.



Telepen

<Default All Telepen Settings>



Telepen On/Off



Telepen Output

Using **AIM Telepen Output**, the scanner reads symbols with start/stop pattern 1 and decodes them as standard full ASCII (start/stop pattern 1). When **Original Telepen Output** is selected, the scanner reads symbols with start/stop pattern 1 and decodes them as compressed numeric with optional full ASCII (start/stop pattern 2). *Default = AIM Telepen Output.*



Telepen Message Length

Scan the barcodes below to change the message length. Refer to [Message Length Description](#) (page 152) for additional information. Minimum and Maximum lengths = 1-60. Minimum Default = 1, Maximum Default = 60.



UPC-A

<Default All UPC-A Settings>



UPC-A On/Off

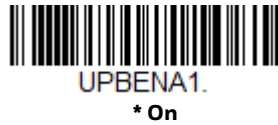

Note: To convert UPC-A barcodes to EAN-13, see [Convert UPC-A to EAN-13](#) on page 178.

UPC-A Check Digit

This selection allows you to specify whether the check digit should be transmitted at the end of the scanned data or not. *Default = On.*



UPC-A Number System

The numeric system digit of a U.P.C. symbol is normally transmitted at the beginning of the scanned data, but can be programmed so it is not transmitted (**Off**). *Default = On.*



UPC-A Addenda

This selection adds 2 or 5 digits to the end of all scanned UPC-A data. *Default = Off for both 2 Digit and 5 Digit Addenda.*



UPC-A Addenda Required

When **Required** is scanned, the scanner will only read UPC-A barcodes that have addenda. You must then turn on a 2 or 5 digit addenda listed on [page 172](#). *Default = Not Required.*





UPAARQ0.
* Not Required

Addenda Timeout

You can set a time during which the scanner looks for an addenda. If an addenda is not found within this time period, the data can be either transmitted or discarded, based on the setting you are using for [UPC-A Addenda Required](#). Set the length (in milliseconds) for this timeout by scanning the barcode below, then setting the timeout (from 0-500 milliseconds) by scanning digits from the [Programming Chart](#), beginning on page 311 of this manual, then **Save**. *Default = 120.*

Note: *The Addenda Timeout setting is applied to all addenda and coupon code searches.*



DLYADD.
Addenda Timeout

UPC-A Addenda Separator

When this feature is **On**, there is a space between the data from the barcode and the data from the addenda. When turned **Off**, there is no space. *Default = On.*



UPAADS1.
* On



UPAADS0.
Off

UPC-A/EAN-13 with Extended Coupon Code

Use the following codes to enable or disable UPC-A and EAN-13 with Extended Coupon Code. When left on the default setting (**Off**), the scanner treats Coupon Codes and Extended Coupon Codes as single barcodes.

If you scan the **Allow Concatenation** code, when the scanner sees the coupon code and the extended coupon code in a single scan, it transmits both as one symbologies. Otherwise, it transmits the first coupon code it reads.

If you scan the **Require Concatenation** code, the scanner must see and read the coupon code and extended coupon code in a single read to transmit the data. No data is output unless both codes are read. *Default = Off.*



Addenda Timeout

You can set a time during which the scanner looks for an addenda. If an addenda is not found within this time period, the data can be either transmitted or discarded, based on the setting you are using for [UPC-A/EAN-13 with Extended Coupon Code](#). Set the length (in milliseconds) for this timeout by scanning the barcode below, then setting the timeout (from 0-500 milliseconds) by scanning digits from the [Programming Chart](#), beginning on page 311 of this manual, then **Save**. *Default = 120.*

Note: *The Addenda Timeout setting is applied to all addenda and coupon code searches.*



Coupon GS1 DataBar Output

If you scan coupons that have both UPC and GS1 Databar codes, you may wish to scan and output only the data from the GS1 Databar code. Scan the **GS1 Output On** code below to scan and output only the GS1 Databar code data. *Default = GS1 Output Off.*



UPC-E0

<Default All UPC-E Settings>



UPC-E0 On/Off

Most U.P.C. barcodes lead with the 0 number system. To read these codes, use the **UPC-E0 On** selection. If you need to read codes that lead with the 1 number system, use **UPC-E1** (page 177). *Default = On.*



UPC-E0 Expand

UPC-E Expand expands the UPC-E code to the 12 digit, UPC-A format. *Default = Off.*



UPC-E0 Addenda Required

When **Required** is scanned, the scanner will only read UPC-E barcodes that have addenda. *Default = Not Required.*



Addenda Timeout

You can set a time during which the scanner looks for an addenda. If an addenda is not found within this time period, the data can be either transmitted or discarded, based on the setting you are using for [UPC-E0 Addenda Required](#). Set the length (in milliseconds) for this timeout by scanning the barcode below, then setting the timeout (from 0-500 milliseconds) by scanning digits from the [Programming Chart](#), beginning on page 311 of this manual, then **Save**. *Default = 120.*

Note: *The Addenda Timeout setting is applied to all addenda and coupon code searches.*



DLYADD.
Addenda Timeout

UPC-E0 Addenda Separator

When this feature is **On**, there is a space between the data from the barcode and the data from the addenda. When turned **Off**, there is no space. *Default = On.*



UPEADS1.
* On



UPEADS0.
Off

UPC-E0 Check Digit

Check Digit specifies whether the check digit should be transmitted at the end of the scanned data or not. *Default = On.*



UPECKX1.
* On



UPECKX0.
Off

UPC-E0 Leading Zero

This feature allows the transmission of a leading zero (0) at the beginning of scanned data. To prevent transmission, scan **Off**. *Default = On.*



UPENSX1.

* On



UPENSX0.

Off

UPC-E0 Addenda

This selection adds 2 or 5 digits to the end of all scanned UPC-E data. *Default = Off for both 2 Digit and 5 Digit Addenda.*



UPEAD21.

2 Digit Addenda On



UPEAD20.

* 2 Digit Addenda Off



UPEAD51.

5 Digit Addenda On



UPEAD50.

* 5 Digit Addenda Off

UPC-E1

Most U.P.C. barcodes lead with the 0 number system. For these codes, use [UPC-E0](#) (page 175). If you need to read codes that lead with the 1 number system, use the **UPC-E1 On** selection. *Default = Off.*



UPEEN11.

UPC-E1 On



EAN/JAN-13

<Default All EAN/JAN Settings>



EAN/JAN-13 On/Off



Convert UPC-A to EAN-13

When **UPC-A Converted to EAN-13** is selected, UPC-A barcodes are converted to 13 digit EAN-13 codes by adding a zero to the front. When **Do not Convert UPC-A** is selected, UPC-A codes are read as UPC-A.



EAN/JAN-13 Check Digit

This selection allows you to specify whether the check digit should be transmitted at the end of the scanned data or not. *Default = On.*



E13CKX1.

* On



E13CKX0.

Off

EAN/JAN-13 Addenda

This selection adds 2 or 5 digits to the end of all scanned EAN/JAN-13 data. *Default = Off for both 2 Digit and 5 Digit Addenda.*



E13AD21.

2 Digit Addenda On



E13AD20.

* 2 Digit Addenda Off



E13AD51.

5 Digit Addenda On



E13AD50.

* 5 Digit Addenda Off

EAN/JAN-13 Addenda Required

When **Required** is scanned, the scanner will only read EAN/JAN-13 barcodes that have addenda. *Default = Not Required.*



E13ARQ1.

Required



E13ARQ0.

* Not Required

EAN-13 Beginning with 290 Addenda Required

This setting programs the scanner to require a 5 digit addenda only on EAN-13 barcodes that begin with “290.” The following settings can be programmed:

Require 5 Digit Addenda: All EAN-13 barcodes that begin with “290” must have a 5 digit addendum. The EAN-13 barcode with the 5 digit addendum is then transmitted as a single, concatenated barcode. If a 5 digit addendum is not found within the [Addenda Timeout](#) period, the EAN-13 barcode is discarded.

Note: *If you are using [EAN-13 Beginning with 290 Addenda Required](#) (page 180), this setting will take precedence.*

Don’t Require 5 Digit Addenda: If you have selected Require 5 Digit Addenda, and you want to disable this feature, scan **Don’t Require 5 Digit Addenda**. EAN-13 barcodes are transmitted, depending on the setting you are using for [EAN/JAN-13 Addenda Required](#).

Default = Don’t Require 5 Digit Addenda.



ARQ2900.

* Don’t Require 5 Digit Addenda



ARQ2901.

Require 5 Digit Addenda

EAN-13 Beginning with 378/379 Addenda Required

This setting programs the scanner to require any combination of a 2 digit addenda or a 5 digit addenda on EAN-13 barcodes that begin with a “378” or “379.” The following settings can be programmed:

Require Addenda: All EAN-13 barcodes that begin with a “378” or “379” must have a 2 digit addenda, a 5 digit addenda, or a combination of these addenda. The EAN-13 barcode with the addenda is then transmitted as a single, concatenated barcode. If the required addenda is not found within the [Addenda Timeout](#) period, the EAN-13 barcode is discarded.

Don’t Require Addenda: If you have selected Require Addenda, and you want to disable this feature, scan **Don’t Require Addenda**. EAN-13 barcodes are transmitted, depending on the setting you are using for [EAN/JAN-13 Addenda Required](#).

Default = Don't Require Addenda.



ARQ3780.

* Don't Require Addenda



ARQ3781.

Require 2 Digit Addenda



ARQ3782.

Require 5 Digit Addenda



ARQ3783.

Require 2 or 5 Digit Addenda

EAN-13 Beginning with 414/419 Addenda Required

This setting programs the scanner to require any combination of a 2 digit addenda or a 5 digit addenda on EAN-13 barcodes that begin with a "414" or "419." The following settings can be programmed:

Require Addenda: All EAN-13 barcodes that begin with a "414" or "419" must have a 2 digit addenda, a 5 digit addenda, or a combination of these addenda. The EAN-13 barcode with the addenda is then transmitted as a single, concatenated barcode. If the required addenda is not found within the [Addenda Timeout](#) period, the EAN-13 barcode is discarded.

Don't Require Addenda: If you have selected Require Addenda, and you want to disable this feature, scan **Don't Require Addenda**. EAN-13 barcodes are transmitted, depending on the setting you are using for [EAN/JAN-13 Addenda Required](#).

Default = Don't Require Addenda.



ARQ4140.

* Don't Require Addenda



ARQ4141.

Require 2 Digit Addenda



ARQ4142.

Require 5 Digit Addenda



ARQ4143.

Require 2 or 5 Digit Addenda

EAN-13 Beginning with 434/439 Addenda Required

This setting programs the scanner to require any combination of a 2 digit addenda or a 5 digit addenda on EAN-13 barcodes that begin with a “434” or “439.” The following settings can be programmed:

Require Addenda: All EAN-13 barcodes that begin with a “434” or “439” must have a 2 digit addenda, a 5 digit addenda, or a combination of these addenda. The EAN-13 barcode with the addenda is then transmitted as a single, concatenated barcode. If the required addenda is not found within the [Addenda Timeout](#) period, the EAN-13 barcode is discarded.

Don't Require Addenda: If you have selected Require Addenda, and you want to disable this feature, scan **Don't Require Addenda**. EAN-13 barcodes are transmitted, depending on the setting you are using for [EAN/JAN-13 Addenda Required](#).

Default = Don't Require Addenda.



ARQ4340.

* Don't Require Addenda



ARQ4341.

Require 2 Digit Addenda



ARQ4342.

Require 5 Digit Addenda



ARQ4343.

Require 2 or 5 Digit Addenda

EAN-13 Beginning with 977 Addenda Required

This setting programs the scanner to require a 2 digit addenda only on EAN-13 barcodes that begin with “977.” The following settings can be programmed:

Require 2 Digit Addenda: All EAN-13 barcodes that begin with “977” must have a 2 digit addendum. The EAN-13 barcode with the 2 digit addendum is then transmitted as a single, concatenated barcode. If a 2 digit addendum is not found within the [Addenda Timeout](#) period, the EAN-13 barcode is discarded.

Don't Require 2 Digit Addenda: If you have selected Require 2 Digit Addenda, and you want to disable this feature, scan **Don't Require 2 Digit Addenda**. EAN-13 barcodes are transmitted, depending on the setting you are using for [EAN/JAN-13 Addenda Required](#).

Default = Don't Require 2 Digit Addenda.



* Don't Require 2 Digit Addenda



Require 2 Digit Addenda

EAN-13 Beginning with 978 Addenda Required

These settings program the scanner to require a 5 digit addenda only on EAN-13 barcodes that begin with "978." The following settings can be programmed:

Require 5 Digit Addenda: All EAN-13 barcodes that begin with "978" must have a 5 digit addendum. The EAN-13 barcode with the 5 digit addendum is then transmitted as a single, concatenated barcode. If a 5 digit addendum is not found within the [Addenda Timeout](#) period, the EAN-13 barcode is discarded.

Don't Require 5 Digit Addenda: If you have selected Require 5 Digit Addenda, and you want to disable this feature, scan **Don't Require 5 Digit Addenda**. EAN-13 barcodes are transmitted, depending on the setting you are using for [EAN/JAN-13 Addenda Required](#).

Default = Don't Require 5 Digit Addenda.



* Don't Require 5 Digit Addenda



Require 5 Digit Addenda

EAN-13 Beginning with 979 Addenda Required

These settings program the scanner to require a 5 digit addenda only on EAN-13 barcodes that begin with "979." The following settings can be programmed:

Require 5 Digit Addenda: All EAN-13 barcodes that begin with "979" must have a 5 digit addendum. The EAN-13 barcode with the 5 digit addendum is then transmitted as a single, concatenated barcode. If a 5 digit addendum is not found within the [Addenda Timeout](#) period, the EAN-13 barcode is discarded.

Don't Require 5 Digit Addenda: If you have selected Require 5 Digit Addenda, and you want to disable this feature, scan **Don't Require 5 Digit Addenda**. EAN-13 barcodes are transmitted, depending on the setting you are using for [EAN/JAN-13 Addenda Required](#).

Default = Don't Require 5 Digit Addenda.



* Don't Require 5 Digit Addenda



Addenda Timeout

You can set a time during which the scanner looks for an addenda. If an addenda is not found within this time period, the data can be either transmitted or discarded, based on the setting you are using for [EAN/JAN-13 Addenda Required](#). Set the length (in milliseconds) for this timeout by scanning the barcode below, then setting the timeout (from 0-500 milliseconds) by scanning digits from the [Programming Chart](#), beginning on page 311 of this manual, then **Save**. *Default = 120.*

Note: *The Addenda Timeout setting is applied to all addenda and coupon code searches.*



EAN/JAN-13 Addenda Separator

When this feature is On, there is a space between the data from the barcode and the data from the addenda. When turned Off, there is no space. *Default = On.*



Note: *If you want to enable or disable EAN13 with Extended Coupon Code, refer to [UPC-A/EAN-13 with Extended Coupon Code](#) (page 173).*

ISBN Translate

When **On** is scanned, EAN-13 Bookland symbols are translated into their equivalent ISBN number format. *Default = Off.*



E13ISB1.

On



E13ISB0.

*** Off**

EAN/JAN-8

<Default All EAN/JAN-8 Settings>



EA8DFT.

EAN/JAN-8 On/Off



EA8ENA1.

*** On**



EA8ENA0.

Off

EAN/JAN-8 Check Digit

This selection allows you to specify whether or not the check digit should be transmitted at the end of the scanned data. *Default = On.*



EA8CKX1.

*** On**



EA8CKX0.

Off

EAN/JAN-8 Addenda

This selection adds 2 or 5 digits to the end of all scanned EAN/JAN-8 data.
Default = Off for both 2 Digit and 5 Digit Addenda.



EA8AD21.
2 Digit Addenda On



EA8AD20.
* 2 Digit Addenda Off



EA8AD51.
5 Digit Addenda On



EA8AD50.
* 5 Digit Addenda Off

EAN/JAN-8 Addenda Required

When **Required** is scanned, the scanner will only read EAN/JAN-8 barcodes that have addenda. *Default = Not Required.*



EA8ARQ1.
Required



EA8ARQ0.
* Not Required

Addenda Timeout

You can set a time during which the scanner looks for an addenda. If an addenda is not found within this time period, the data can be either transmitted or discarded, based on the setting you are using for [EAN/JAN-8 Addenda Required](#). Set the length (in milliseconds) for this timeout by scanning the barcode below, then

setting the timeout (from 0-500 milliseconds) by scanning digits from the [Programming Chart](#), beginning on page 311 of this manual, then **Save**. *Default = 120.*

Note: *The Addenda Timeout setting is applied to all addenda and coupon code searches.*



EAN/JAN-8 Addenda Separator

When this feature is **On**, there is a space between the data from the barcode and the data from the addenda. When turned **Off**, there is no space. *Default = On.*



MSI

<Default All MSI Settings>



MSI On/Off



MSI Check Character

Different types of check characters are used with MSI barcodes. You can program the scanner to read MSI barcodes with Type 10 check characters. *Default = Validate Type 10, but Don't Transmit.*

When Check Character is set to **Validate Type 10/11 and Transmit**, the scanner will only read MSI barcodes printed with the specified type check character(s), and will transmit the character(s) at the end of the scanned data.

When Check Character is set to **Validate Type 10/11, but Don't Transmit**, the unit will only read MSI barcodes printed with the specified type check character(s), but will not transmit the check character(s) with the scanned data.



MSICK0.

* Validate Type 10, but Don't Transmit



MSICK1.

Validate Type 10 and Transmit



MSICK2.

Validate 2 Type 10 Characters, but Don't Transmit



MSICK3.

Validate 2 Type 10 Characters and Transmit



MSICK4.

Validate Type 11 then Type 10 Character, but Don't Transmit



MSICK5.

Validate Type 11 then Type 10 Character and Transmit



MSICK6.

Disable MSI Check Characters

MSI Message Length

Scan the barcodes below to change the message length. Refer to [Message Length Description](#) (page 152) for additional information. Minimum and Maximum lengths = 4-48. Minimum Default = 4, Maximum Default = 48.



MSIMIN.

Minimum Message Length



MSIMAX.

Maximum Message Length

GS1 DataBar Omnidirectional

< Default All GS1 DataBar Omnidirectional Settings >



RSSDFT.

GS1 DataBar Omnidirectional On/Off



RSENA1.

* On



RSENA0.

Off

GS1 DataBar Limited

< Default All GS1 DataBar Limited Settings >



GS1 DataBar Limited On/Off



GS1 DataBar Expanded

< Default All GS1 DataBar Expanded Settings >



GS1 DataBar Expanded On/Off



GS1 DataBar Expanded Message Length

Scan the barcodes below to change the message length. Refer to [Message Length Description](#) (page 152) for additional information. Minimum and Maximum lengths = 4-74. Minimum Default = 4, Maximum Default = 74.





Trioptic Code

Note: If you are going to scan Code 32 Pharmaceutical codes ([page 157](#)), Trioptic Code must be off.

Trioptic Code is used for labeling magnetic storage media.



Codablock A

<Default All Codablock A Settings>



Codablock A On/Off

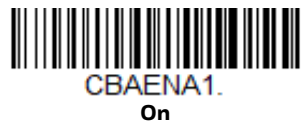

If you are reading Code 39 barcodes, Codablock A should remain disabled. If you are enabling Codablock A, you should disable Code 39 (see [Code 39](#) on page 155).

Codablock A Message Length

Scan the barcodes below to change the message length. Refer to [Message Length Description](#) (page 152) for additional information. Minimum and Maximum lengths = 1-600. Minimum Default = 1, Maximum Default = 600.



CBAMIN.

Minimum Message Length



CBAMAX.

Maximum Message Length

Codablock F

<Default All Codablock F Settings>



CBFDF.

Codablock F On/Off



CBFENA1.

On



CBFENA0.

*** Off**

If you are reading Code 128 barcodes, Codablock F should remain disabled. If you are enabling Codablock F, you should disable Code 128 (see [Code 128](#) on page 167).

Codablock F Message Length

Scan the barcodes below to change the message length. Refer to [Message Length Description](#) (page 152) for additional information. Minimum and Maximum lengths = 1-2048. Minimum Default = 1, Maximum Default = 2048.



CBFMIN.

Minimum Message Length



Label Code

The standard Label Code is used in libraries. *Default = Off.*



PDF417

< Default All PDF417 Settings >



PDF417 On/Off



PDF417 Message Length

Scan the barcodes below to change the message length. Refer to [Message Length Description](#) (page 152) for additional information. Minimum and Maximum lengths = 1-2750. Minimum Default = 1, Maximum Default = 2750.



MacroPDF417

MacroPDF417 is an implementation of PDF417 capable of encoding very large amounts of data into multiple PDF417 barcodes. When this selection is enabled, these multiple barcodes are assembled into a single data string. *Default = On.*



MicroPDF417

< Default All MicroPDF417 Settings >



MicroPDF417 On/Off





MicroPDF417 Message Length

Scan the barcodes below to change the message length. Refer to [Message Length Description](#) (page 152) for additional information. Minimum and Maximum lengths = 1-366. Minimum Default = 1, Maximum Default = 366.



GS1 Composite Codes

Linear codes are combined with a unique 2D composite component to form a new class called GS1 Composite symbology. GS1 Composite symbologies allow for the co-existence of symbologies already in use. *Default = Off.*



UPC/EAN Version

Scan the **UPC/EAN Version On** barcode to decode GS1 Composite symbols that have a U.P.C. or an EAN linear component. (This does not affect GS1 Composite symbols with a GS1-128 or GS1 linear component.) *Default = UPC/EAN Version Off.*



Note: *If you scan coupons that have both UPC and GS1 Databar codes, you may wish to scan and output only the data from the GS1 Databar code. See [Coupon GS1 DataBar Output](#) (page 174) for further information.*

GS1 Composite Code Message Length

Scan the barcodes below to change the message length. Refer to [Message Length Description](#) (page 152) for additional information. Minimum and Maximum lengths = 1-2435. Minimum Default = 1, Maximum Default = 2435.



GS1 Emulation

The scanner can automatically format the output from any GS1 data carrier to emulate what would be encoded in an equivalent GS1-128 or GS1 DataBar symbol. GS1 data carriers include UPC-A and UPC-E, EAN-13 and EAN-8, ITF-14, GS1-128, and GS1 DataBar and GS1 Composites. (Any application that accepts GS1 data can be simplified since it only needs to recognize one data carrier type.)

If **GS1-128 Emulation** is scanned, all retail codes (U.P.C., UPC-E, EAN8, EAN13) are expanded out to 16 digits. If the **AIM ID** is enabled, the value will be the GS1-128 AIM ID,]C1 (see [Symbology Charts](#) on page 297).

If **GS1 DataBar Emulation** is scanned, all retail codes (U.P.C., UPC-E, EAN8, EAN13) are expanded out to 16 digits. If the AIM ID is enabled, the value will be the GS1-DataBar AIM ID,]em (see [Symbology Charts](#) on page 297).

If **GS1 Code Expansion Off** is scanned, retail code expansion is disabled, and UPC-E expansion is controlled by the [UPC-E0 Expand](#) (page 175) setting. If the AIM ID is enabled, the value will be the GS1-128 AIM ID,]C1 (see [Symbology Charts](#) on page 297).

If **EAN8 to EAN13 Conversion** is scanned, all EAN8 barcodes are converted to EAN13 format.

Default = GS1 Emulation Off.



EANEMU1.
GS1-128 Emulation



EANEMU2.
GS1 DataBar Emulation



EANEMU3.
GS1 Code Expansion Off



EANEMU4.
EAN8 to EAN13 Conversion



EANEMU0.
* GS1 Emulation Off

TCIF Linked Code 39 (TLC39)

This code is a composite code since it has a Code 39 linear component and a MicroPDF417 stacked code component. All barcode readers are capable of reading the Code 39 linear component. The MicroPDF417 component can only be decoded if TLC39 **On** is selected. The linear component may be decoded as Code 39 even if TLC39 is off. *Default = Off.*



T39ENA1.
On



T39ENA0.
* Off

QR Code

< Default All QR Code Settings >



QR Code On/Off

This selection applies to both QR Code and Micro QR Code.



QR Code Message Length

Scan the barcodes below to change the message length. Refer to [Message Length Description](#) (page 152) for additional information. Minimum and Maximum lengths = 1-7089. Minimum Default = 1, Maximum Default = 7089.



QR Code Append

This function allows the scanner to append the data from several QR Code barcodes together before transmitting them to the host computer. When the scanner encounters an QR Code barcode with the append trigger character(s), it buffers the number of QR Code barcodes determined by information encoded in those barcodes. Once the proper number of codes is reached, the data is output in the order specified in the barcodes. There are 3 ways to scan appended QR Code:

One Scan: Pull the trigger one time and all appended QR Codes in the same image are decoded.

Swipe: Pull and hold down the trigger and scan all appended QR Codes while keeping the trigger pressed. The scanner emits short beeps for each partial QR Code that is scanned and buffered. One long beep is emitted after the last QR Code is scanned and the data is complete. Not compatible with Presentation mode.

Point and Shoot: Pull the trigger one time for each image. The scanner emits a short beep for each partial QR Code that is scanned and buffered. One long beep is emitted after the last QR Code is scanned and the data is complete. Not compatible with Presentation mode.

Default = One Scan.



QRCAPP1.
* One Scan



QRCAPP2.
Swipe



QRCAPP3.
Point and Shoot



QRCAPP0.
Off

QR Code Page

QR Code pages define the mapping of character codes to characters. If the data received does not display with the proper characters, it may be because the barcode being scanned was created using a code page that is different from the one the host program is expecting. If this is the case, scan the barcode below, select the code page with which the barcodes were created (see [ISO 2022/ISO 646 Character Replacements](#) on page 304), and scan the value and the **Save** barcode from the [Programming Chart](#), beginning on page 311. The data characters should then appear properly.



QRCDP.
QR Code Page

DotCode

< Default All DotCode Settings >



DotCode On/Off



Poor Quality DotCodes

This setting improves the scanner's ability to read damaged or badly printed DotCodes. *Default = Poor Quality DotCodes Off.*



DotCode Message Length

Scan the barcodes below to change the message length. Refer to [Message Length Description](#) (page 152) for additional information. Minimum and Maximum lengths = 1-2400. Minimum Default = 1, Maximum Default = 2400.



Digimarc Barcode™

Digimarc Decoder Attempts

Set the number of attempts by scanning the barcode below, then setting the number of attempts (0-10) by scanning digits from the [Programming Chart](#) beginning on page 311 of this manual, the **Save**. *Minimum to Maximum attempts = 0-10. Default = 3.*



Digimarc Decoder Attempts

Digimarc Barcode

This setting programs the scanner to decode Digimarc Barcode using Digimarc and ID decoders. When Digimarc Barcode is set to **On**, the Digimarc decoder is used on most frames and the ID decoder will read every fifth frame.

When Digimarc Barcode is set to **Uses ID Decoder then Both Decoders**, the ID decoder will read the number of attempts set by the Digimarc Decoder Attempts and then will use both ID and Digimarc decoders. When Digimarc Barcode is set to **Uses Digimarc Decoder then Both Decoders**, the Digimarc decoder will read the number of attempts set by the Digimarc Decoder Attempts and then will use both ID and Digimarc decoders.

When Digimarc Barcode is set to **Uses ID Decoder then Alternates Decoders**, the ID decoder will read the number of attempts set by the Digimarc Decoder Attempts and then will alternate between ID and Digimarc decoders. When Digimarc Barcode is set to **Uses Digimarc Decoder then Alternates Decoders**, the Digimarc decoder will read the number of attempts set by the Digimarc Decoder Attempts and then will alternate between ID and Digimarc decoders.

Default = Uses Digimarc Decoder then Both Decoders.



DIGENA0.

Off



DIGENA1.

On



DIGENA2.

Uses ID Decoder then Both Decoders



DIGENA4.

Uses ID Decoder then
Alternates Decoders



DIGENA3.

* Uses Digimarc Decoder then
Both Decoders



DIGENA5.

Uses Digimarc Decoder then
Alternates Decoders

Data Matrix

< Default All Data Matrix Settings >



IDMDFT.

Data Matrix On/Off



IDMENA1.

* On



IDMENA0.

Off

Direct Part Marking Decoding

If you are having trouble reading Direct Part Marking (DPM) barcodes, scan **Dotpeen DPM Decoding** for Dotpeen codes or scan **Reflective (Etched) DPM Decoding** for reflective (etched) codes. *Default = Disable DPM Decoding.*



DPMENA1.

Dotpeen DPM Decoding



DPMENA0.

* Disable DPM Decoding



DPMENA2.

Reflective (Etched) DPM
Decoding

Data Matrix Message Length

Scan the barcodes below to change the message length. Refer to [Message Length Description](#) (page 152) for additional information. Minimum and Maximum lengths = 1-3116. Minimum Default = 1, Maximum Default = 3116.



IDMMIN.

Minimum Message Length



IDMMAX.

Maximum Message Length

Data Matrix Code Page

Data Matrix Code pages define the mapping of character codes to characters. If the data received does not display with the proper characters, it may be because the barcode being scanned was created using a code page that is different from the one the host program is expecting. If this is the case, scan the barcode below, select the code page with which the barcodes were created (see [ISO 2022/ISO 646 Character Replacements](#) on page 304), and scan the value and the **Save** barcode from the [Programming Chart](#), beginning on page 311. The data characters should then appear properly.



IDMDCP.

Data Matrix Code Page

MaxiCode

< Default All MaxiCode Settings >



MaxiCode On/Off



MaxiCode Message Length

Scan the barcodes below to change the message length. Refer to [Message Length Description](#) (page 152) for additional information. Minimum and Maximum lengths = 1-150. Minimum Default = 1, Maximum Default = 150.



Aztec Code

< Default All Aztec Code Settings >



Aztec Code On/Off



Aztec Code Message Length

Scan the barcodes below to change the message length. Refer to [Message Length Description](#) (page 152) for additional information. Minimum and Maximum lengths = 1-3832. Minimum Default = 1, Maximum Default = 3832.



Aztec Append

This function allows the scanner to append the data from several Aztec barcodes together before transmitting them to the host computer. When the scanner encounters an Aztec barcode with the append trigger character(s), it buffers the number of Aztec barcodes determined by information encoded in those barcodes. Once the proper number of codes is reached, the data is output in the order specified in the barcodes. *Default = On.*





Aztec Code Page

Aztec Code pages define the mapping of character codes to characters. If the data received does not display with the proper characters, it may be because the barcode being scanned was created using a code page that is different from the one the host program is expecting. If this is the case, scan the barcode below, select the code page with which the barcodes were created (see [ISO 2022/ISO 646 Character Replacements](#) on page 304), and scan the value and the **Save** barcode from the [Programming Chart](#), beginning on page 311. The data characters should then appear properly.



Chinese Sensible (Han Xin) Code

< Default All Han Xin Settings >



Han Xin Code On/Off

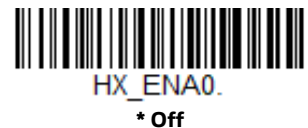

Han Xin Code Message Length

Scan the barcodes below to change the message length. Refer to [Message Length Description](#) (page 152) for additional information. Minimum and Maximum lengths = 1-7833. Minimum Default = 1, Maximum Default = 7833.



Postal Codes - 2D

The following lists the possible 2D postal codes, and 2D postal code combinations that are allowed. Only one 2D postal code selection can be active at a time. If you scan a second 2D postal code selection, the first selection is overwritten. *Default = 2D Postal Codes Off.*



Single 2D Postal Codes:





POSTAL3.
Japanese Post On



POSTAL4.
KIX Post On



POSTAL5.
Planet Code On

Also see [Planet Code Check Digit](#), page 210.



POSTAL9.
Postal-4i On



POSTAL6.
Postnet On

Also see [Postnet Check Digit](#), page 211.



POSTAL11.
Postnet with B and B' Fields On



POSTAL2.
InfoMail On

Combination 2D Postal Codes:



POSTAL8.
InfoMail and British Post On



POSTAL20.
Intelligent Mail Barcode and Postnet with B and B' Fields On



POSTAL14.
Postnet and
Postal-4i On



POSTAL17.
Postal-4i and
Intelligent Mail Barcode On



POSTAL12.
Planet Code and
Postnet On



POSTAL13.
Planet Code and
Postal-4i On



POSTAL21.
Planet Code,
Postnet, and
Postal-4i On



POSTAL16.
Postnet and
Intelligent Mail Barcode On



POSTAL19.
Postal-4i and
Postnet with B and B' Fields On



POSTAL18.
Planet Code and
Postnet with B and B' Fields On



POSTAL15.
Planet Code and
Intelligent Mail Barcode



POSTAL22.
Planet Code,
Postnet, and
Intelligent Mail Barcode On



POSTAL23.
Planet Code,
Postal-4i, and
Intelligent Mail Barcode On



POSTAL24.
Postnet,
Postal-4i, and
Intelligent Mail Barcode On



POSTAL25.
Planet Code,
Postal-4i, and
Postnet with B and B' Fields On



POSTAL26.
Planet Code,
Intelligent Mail Barcode, and
Postnet with B and B' Fields On



POSTAL27.
Postal-4i,
Intelligent Mail Barcode, and
Postnet with B and B' Fields On



POSTAL28.
Planet Code,
Postal-4i,
Intelligent Mail Barcode, and
Postnet On



POSTAL29.
Planet Code,
Postal-4i,
Intelligent Mail Barcode, and
Postnet with B and B' Fields On

Planet Code Check Digit

This selection allows you to specify whether the check digit should be transmitted at the end of Planet Code data. *Default = Don't Transmit.*



PLNCKX1.
Transmit Check Digit



Postnet Check Digit

This selection allows you to specify whether the check digit should be transmitted at the end of Postnet data. *Default = Don't Transmit.*



Australian Post Interpretation

This option controls what interpretation is applied to customer fields in Australian 4-State symbols.

Bar Output lists the bar patterns in "0123" format.

Numeric N Table causes that field to be interpreted as numeric data using the N Table.

Alphanumeric C Table causes the field to be interpreted as alphanumeric data using the C Table. Refer to the Australian Post Specification Tables.

Combination C and N Tables causes the field to be interpreted using either the C or N Tables.





Postal Codes - Linear

The following lists linear postal codes. Any combination of linear postal code selections can be active at a time.

China Post (Hong Kong 2 of 5)

<Default All China Post (Hong Kong 2 of 5) Settings>



China Post (Hong Kong 2 of 5) On/Off



China Post (Hong Kong 2 of 5) Message Length

Scan the barcodes below to change the message length. Refer to [Message Length Description](#) (page 152) for additional information. Minimum and Maximum lengths = 2-80. Minimum Default = 4, Maximum Default = 80.



Korea Post

<Default All Korea Post Settings>



Korea Post



Korea Post Message Length

Scan the barcodes below to change the message length. Refer to [Message Length Description](#) (page 152) for additional information. Minimum and Maximum lengths = 2-80. Minimum Default = 4, Maximum Default = 48.



Korea Post Check Digit

This selection allows you to specify whether the check digit should be transmitted or not. *Default = Don't Transmit.*



IMAGING COMMANDS

The scanner is like a digital camera in the way it captures, manipulates, and transfers images. The following commands allow you to alter the way the scanner performs these functions.

Note: *If you are using the scanner in a stand, you must set the In-Stand Sensor Mode to Off in order to take images (see [In-Stand Sensor Mode](#) on page 92).*

Single-Use Basis

Imaging Commands with their modifiers send instructions to the scanner on a single-use basis, and take effect for a single image capture. Once that capture is complete, the scanner reverts to its imaging default settings. If you want to permanently change a setting, you must use the serial default commands (see [Chapter 11](#)). When the serial default command is used, that selection becomes the new, permanent setting for the scanner.

Command Syntax

Multiple modifiers and commands can be issued within one sequence. If additional modifiers are to be applied to the same command, just add the modifiers to that command. For example, to add 2 modifiers to the Image Snap command, such as setting the Imaging Style to 1P and the Wait for Trigger to 1T, you would enter **IMGSNP1P1T**.

Note: *After processing an image capture command (IMGSNP or IMGBOX), you must follow it with an IMGSHIP command if you want to see it on your terminal.*

To add a command to a sequence, each new command is separated with a semicolon. For example, to add the Image Ship command to the above sequence, you would enter IMGSNP1P1T;IMGSHIP.

The imaging commands are:

[Image Snap - IMGSNP](#) (page 216)

[Image Ship - IMGSHIP](#) (page 219)

[Intelligent Signature Capture - IMGBOX](#) (page 228)

The modifiers for each of these commands follow the command description.

Note: *The images included with each command description are examples only. The results you achieve may be different from those included in this manual. The quality of the output you receive will vary depending on lighting, quality of the initial image/object being captured, and distance of the scanner from the image/object. To achieve a high quality image, it is recommended that you position your scanner 4-6" (10.2-15.2 cm) away from the image/object you are capturing.*

Step 1 - Take a Picture Using IMGSNP

Image Snap - IMGSNP

An image is taken whenever the hardware trigger is pressed, or when the Image Snap (IMGSNP) command is processed.

The image snap command has many different modifiers that can be used to change the look of the image in memory. Any number of modifiers may be appended to the IMGSNP command.

Example: You can use the following command to snap an image, increase the gain, and have the beeper sound once the snap is complete: **IMGSNP2G1B**

IMGSNP Modifiers

P - Imaging Style

This sets the Image Snap style.

- 0P **Decoding Style.** This processing allows a few frames to be taken until the exposure parameters are met. The last frame is then available for further use.
- 1P **Photo Style (default).** This mimics a simple digital camera, and results in a visually optimized image.
- 2P **Manual Style.** This is an advanced style that should only be used by an experienced user. It allows you the most freedom to set up the scanner, and has no auto-exposure.

B - Beeper

Causes a beep to sound after an image is snapped.

- 0B No beep (*default*)
- 1B Sounds a beep when the image is captured

T - Wait for Trigger

Waits for a hardware trigger press before taking the image. This is only available when using Photo Style (1P).

- 0T Takes image immediately (*default*)
- 1T Waits for a trigger press, then takes the image

L - LED State

Determines if the LEDs should be on or off, and when. Ambient illumination (0L) is preferred for taking pictures of color documents, such as ID cards, especially when the scanner is in a stand. LED illumination (1L) is preferred when the scanner is handheld. LED State is not available when using Decoding Style (0P).

- 0L LEDs off (*default*)
- 1L LEDs on

E - Exposure

Exposure is used in Manual Style only (2P), and allows you to set the exposure time. This is similar to setting a shutter speed on a camera. The exposure time determines how long the scanner takes to record an image. On a bright day, exposure times can be very short because plenty of light is available to help record an image. At nighttime, exposure time can increase dramatically due to the near absence of light. Units are 127 microseconds. (*Default = 7874*)

- nE Range: 1 - 7874

Example: Exposure at 7874E with fluorescent lighting:

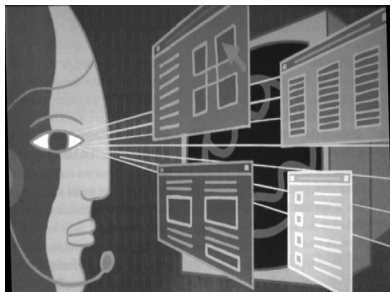

Example: Exposure at 100E with fluorescent lighting:



G - Gain

Gain is used in Manual Style only (2P). Like a volume control, the gain modifier boosts the signal and multiplies the pixel value. As you increase the gain, the noise in an image is also amplified.

1G No gain (*default*)

2G Medium gain

4G Heavy gain

8G Maximum gain

Example:

Gain at 1G:



Gain at 4G:



Gain at 8G:



W - Target White Value

Sets the target for the median grayscale value in the captured image. For capturing close-up images of high contrast documents, a lower setting, such as 75, is recommended. Higher settings result in longer exposure times and brighter images, but if the setting is too high, the image may be overexposed. Target White Value is only available when using Photo Style (1P). (*Default = 125*)

*n*W Range: 0 - 255

Example:

White Value at 75W:



White Value at 125W:



White Value at 200W:



D - Delta for Acceptance

This sets the allowable range for the white value setting ([see W - Target White Value](#)). Delta is only available when using Photo Style (1P). (*Default = 25*)

*n*D Range: 0 - 255

U - Update Tries

This sets the maximum number of frames the scanner should take to reach the [D - Delta for Acceptance](#). Update Tries is only available when using Photo Style (1P). (Default = 6)

nU Range: 0 - 10

% - Target Set Point Percentage

Sets the target point for the light and dark values in the captured image. A setting of 75% means 75% of the pixels are at or below the target white value, and 25% of the pixels are above the target white value. Altering this setting from the default is not recommended under normal circumstances. To alter grayscale values, [W - Target White Value](#) should be used. (Default = 50)

n% Range: 1 - 99

Example:

Target Set Point Percentage at 97%:

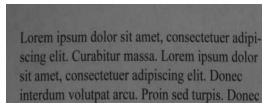

Target Set Point Percentage at 50%:

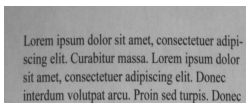

Target Set Point Percentage at 40%:

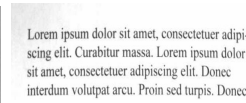

Step 2 - Ship a Picture Using IMGSHIP

Image Ship - IMGSHIP

An image is taken whenever the trigger is pressed or when the Image Snap (IMGSNP) command is processed. The last image is always stored in memory. You can “ship” the image by using the IMGSHIP command.

The image ship commands have many different modifiers that can be used to change the look of the image output. Modifiers affect the image that is transmitted, but do not affect the image in memory. Any number of modifiers may be appended to the IMGSHIP command.

Example: You can use the following command to snap and ship a bitmap image with gamma correction and document image filtering: `IMGSNP;IMGSHIP8F75K26U`.

IMGSHHP Modifiers

A - Infinity Filter

Enhances pictures taken from very long distances (greater than 10 feet or 3m). The Infinity Filter should not be used with [IMGSNP Modifiers](#) (page 216).

0A Infinity filter off (*default*)

1A Infinity filter on

Example:

Infinity Filter off (0A)
from approximately 12 feet
(3.66m) away:

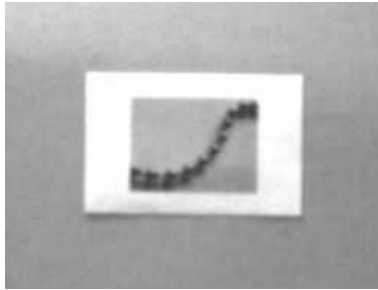

Infinity Filter on (1A)
from approximately 12 feet (3.66m)
away:

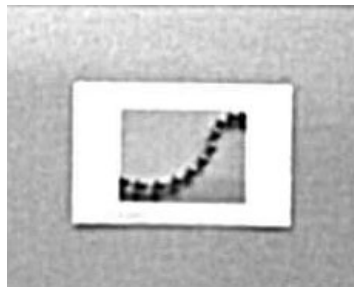

C - Compensation

Flattens the image to account for variations in illumination across the image.

0C Compensation disabled (*default*)

1C Compensation enabled

Example:

Compensation at 0C:



Compensation at 1C:



D - Pixel Depth

Indicates the number of bits per pixel in the transmitted image (KIM or BMP format only).

8D 8 bits per pixel, grayscale image (*default*)

1D 1 bit per pixel, black and white image

E - Edge Sharpen

An edge sharpen filter cleans up the edges of an image, making it look cleaner and sharper. While edge sharpening does make the image look cleaner, it also removes some fine detail from the original image. The strength of the edge sharpen filter can be entered from 1 to 24. Entering a **23E** gives the sharpest edges, but also increases noise in the image.

- 0E Don't sharpen image (*default*)
- 14E Apply edge sharpen for typical image
- ne* Apply edge sharpen using strength *n* ($n = 1-24$)

Example:

Edge Sharpen at 0E:



Edge Sharpen at 24E:



F - File Format

Indicates the desired format for the image.

- 0F KIM format
- 1F TIFF binary
- 2F TIFF binary group 4, compressed
- 3F TIFF grayscale
- 4F Uncompressed binary (upper left to lower right, 1 pixel/bit, 0 padded end of line)
- 5F Uncompressed grayscale (upper left to lower right, bitmap format)
- 6F JPEG image (*default*)
- 8F BMP format (lower right to upper left, uncompressed)
- 15F BMP Uncompressed raw image

H - Histogram Stretch

Increases the contrast of the transmitted image. Not available with some image formats.

0H No stretch (*default*)

1H Histogram stretch

Example:

Histogram Stretch at 0H:



Histogram Stretch at 1H:

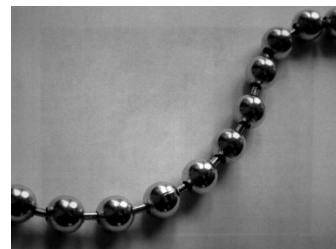

I - Invert Image

Invert image is used to rotate the image around the X or Y axis.

1ix Invert around the X axis (flips picture upside down)

1iy Invert around the Y axis (flips picture left to right)

Example:

Image not inverted:



Image with Invert Image set to 1ix:



Image with Invert Image set to 1iy:



IF- Noise Reduction

Used to reduce the salt and pepper noise in an image.

0if No salt and pepper noise reduction (default)

1if Salt and pepper noise reduction

Example:

Noise Reduction Off (0if):



Noise Reduction On (1if):



IR - Image Rotate

0ir Image as snapped (rightside up) (default)

1ir Rotate image 90 degrees to the right

2ir Rotate image 180 degrees (upside down)

3ir Rotate image 90 degrees to the left

Example:

Image Rotate set to 0ir:



Image Rotate set to 2ir:



Image Rotate set to 1ir:



Image Rotate set to 3ir:



J - JPEG Image Quality

Sets the desired quality when the JPEG image format is selected. Higher numbers result in higher quality, but larger files. Smaller numbers result in greater amounts of lossy compression, faster transmission times, lower quality, but smaller files. (Default = 50)

- nJ Image is compressed as much as possible while preserving quality factor of n ($n = 0 - 100$)
- 0J worst quality (smallest file)
- 100J best quality (largest file)

K - Gamma Correction

Gamma measures the brightness of midtone values produced by the image. You can brighten or darken an image using gamma correction. A higher gamma correction yields an overall brighter image. The lower the setting, the darker the image. The optimal setting for text images is 50K.

- 0K Gamma correction off (default)
- 50K Apply gamma correction for brightening typical document image
- nK Apply gamma correction factor n ($n = 0-1,000$)

Example:

Gamma Correction set to 0K:



Gamma Correction set to 50K:



Gamma Correction set to 255K:



L, R, T, B, M - Image Cropping

Ships a window of the image by specifying the left, right, top, and bottom pixel coordinates. Device columns are numbered 0 through 1279, and device rows are numbered 0 through 959.

- nL The left edge of the shipped image corresponds to column n of the image in memory. Range: 000 - 843. (Default = 0)
- nR The right edge of the shipped image corresponds to column $n - 1$ of the image in memory. Range: 000 - 843. (Default = all columns)
- nT The top edge of the shipped image corresponds to row n of the image in memory. Range: 000 - 639. (Default = 0)

nB The bottom edge of the shipped image corresponds to row $n - 1$ of the image in memory. Range: 000 - 639. (Default = all rows)

Example:

Uncropped Image:



Image Crop set to 300R:



Image Crop set to 300L:

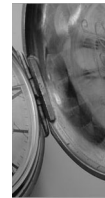

Image Crop set to 200B:



Image Crop set to 200T:



Alternately, specify the number of pixels to cut from the outside margin of the image; thus only the center pixels are transmitted.

nM Margin: cut n columns from the left, $n + 1$ columns from the right, n rows from the top, and $n + 1$ rows from the bottom of the image. Ship the remaining center pixels. Range: 0 - 238. (Default = 0, or full image)

Example:

Image Crop set to 238M:



P - Protocol

Used for shipping an image. Protocol covers two features of the image data being sent to the host. It addresses the protocol used to send the data (Hmodem, which is an Xmodem 1K variant that has additional header information), and the format of the image data that is sent.

- 0P None (raw data)
- 2P None (default for USB)
- 3P Hmodem compressed (default for RS232)
- 4P Hmodem

S - Pixel Ship

Pixel Ship sizes an image in proportion to its original size. It decimates the image by shipping only certain, regularly spaced pixels.

Example: 4S would transmit every fourth pixel from every fourth line.

The smaller number of pixels shipped, the smaller the image, however, after a certain point the image becomes unusable.

- 1S ship every pixel (*default*)
- 2S ship every 2nd pixel, both horizontally and vertically
- 3S ship every 3rd pixel, both horizontally and vertically

Example:

Pixel Ship set to 1S:



Pixel Ship set to 2S:



Pixel Ship set to 3S:



Pixel Ship set to 4S:



U - Document Image Filter

Allows you to input parameters to sharpen the edges and smooth the area between the edges of text in an image. This filter should be used with gamma correction (see [page 224](#)), with the scanner in a stand, and the image captured using the command:

IMGSP1POL168W90%32D

This filter typically provides better JPEG compression than the standard E - Edge Sharpen command (see [page 227](#)). This filter also works well when shipping pure black and white images (1 bit per pixel). The optimal setting is 26U.

- 0U Document image filter off (*default*)
- 26U Apply document image filter for typical document image
- nU Apply document image filter using grayscale threshold n. Use lower numbers when the image contrast is lower. 1U will have a similar effect to setting [E - Edge Sharpen](#) (page 221) to 22e. Range: 0-255.

Example:

Document Image Filter set to 0U:



Document Image Filter set to 26U:

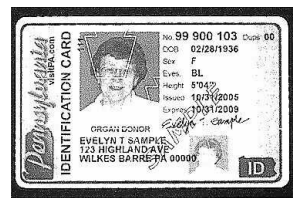

V - Blur Image

Smooths transitions by averaging the pixels next to the hard edges of defined lines and shaded areas in an image.

0V Don't blur (*default*)

1V Blur

Example:

Blur Image Off (0V):



Blur Image On (1V):



W - Histogram Ship

A histogram gives a quick picture of the tonal range of an image, or key type. A low-key image has detail concentrated in the shadows; a high-key image has detail concentrated in the highlights; and an average-key image has detail concentrated in the midtones. This modifier ships the histogram for an image.

0W Don't ship histogram (*default*)

1W Ship histogram

Example:

Image used for histogram:

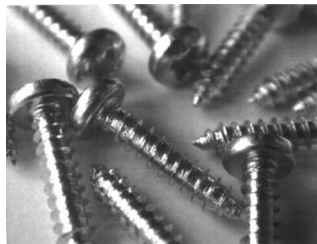

Histogram of image:



Image Size Compatibility

If you have applications that expect an image ship to return exactly 640x480 pixels, scan the Force VGA Resolution barcode. *Default = Native Resolution.*



IMGVGA1.

Force VGA Resolution



Intelligent Signature Capture - IMGBOX

IMGBOX allows you to configure the size and location of a signature capture area relative to its proximity to a barcode. This allows you to tailor a signature capture area to a specific form. In order to use IMGBOX, you need a set form where the signature box location is in a known location relative to a barcode. You can input the overall size of the signature area, as well as specify how far the signature area is from the barcode, vertically and horizontally. You can also set the resolution and file format for the final output of the signature capture image.

Note: *IMGBOX commands can only be triggered by one of the following types of barcodes: PDF417, Code 39, Code 128, Aztec, Codabar, and Interleaved 2 of 5. Once one of these symbologies has been read, the image is retained for a possible IMGBOX command.*

Signature Capture Optimize

If you will be using your scanner to capture signatures frequently, you should optimize it for this purpose. However, the speed of scanning barcodes may be slowed when this mode is enabled. *Default = Off.*



Below is an example of a signature capture application. In this example, the aimer is centered over the signature capture area and the trigger is pressed. A single beep is emitted, indicating that the scanner has read a Code 128 barcode and the data has been transferred to the host. An IMGBOX command may now be sent from the host to specify the coordinates of the signature capture area below that code, and indicating that only that area containing the signature should be transferred as an image to the host.

To see this example, align the aimer with the signature area (not with the barcode), then press the trigger.



Send the following IMGBOX command string after the trigger press:

Example: IMGBOX245w37h55y.

Note: Case is not important in the command string. It is used here only for clarity.

The following image is captured:



The IMGBOX commands have many different modifiers that can be used to change the size and appearance of the signature image output by the scanner. Modifiers affect the image that is transmitted, but do not affect the image in memory. Any number of modifiers may be appended to the IMGBOX command.

Note: The IMGBOX command will return a NAK unless a window size (width and height) are specified. See [H - Height of Signature Capture Area](#) (page 231) and [W - Width of Signature Capture Area](#) (page 232).

IMGBOX Modifiers

A - Output Image Width

This option is used to size the image horizontally. If using this option, set the resolution (R) to zero.

Example: **Image Width set to 200A:**

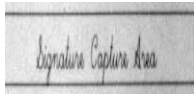
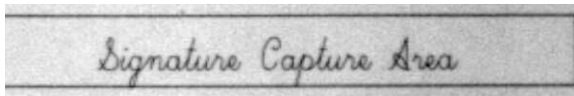

Image Width set to 600A:



B - Output Image Height

This option is used to size the image vertically. If using this option, set the resolution (R) to zero.

Example:

Image Height set to 50B:

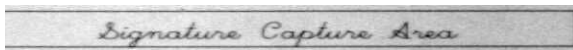
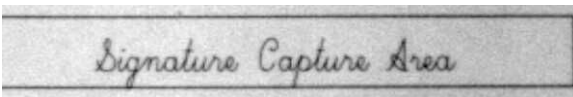

Image Height set to 100B:



D - Pixel Depth

This indicates the number of bits per pixel in the transmitted image, which defines whether it will be grayscale or black and white.

- 8D 8 bits per pixel, grayscale image (*default*)
- 1D 1 bit per pixel, black and white image

F - File Format

This option indicates the type of file format in which to save the image.

- 0F KIM format
- 1F TIFF binary
- 2F TIFF binary group 4, compressed
- 3F TIFF grayscale
- 4F Uncompressed Binary
- 5F Uncompressed grayscale
- 6F JPEG image (*default*)
- 7F Outlined image
- 8F BMP format

H - Height of Signature Capture Area

The height of the signature capture area must be measured in inches divided by .01. In the example, the height of the area to be captured is 3/8 inch, resulting in a value of $H = .375/0.01 = 37.5$.

Example: *IMGBOX245w37h55y*

K - Gamma Correction

Gamma measures the brightness of midtone values produced by the image. You can brighten or darken an image using gamma correction. A higher gamma correction yields an overall brighter image. The lower the setting, the darker the image. The optimal setting for text images is 50K.

0K Gamma correction off (*default*)

50K Apply gamma correction for brightening typical document image

nK Apply gamma correction factor n ($n = 1-255$)

Example:

Gamma Correction set to 0K:



Gamma Correction set to 50K:



Gamma Correction set to 255K:

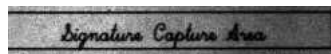

R - Resolution of Signature Capture Area

The resolution is the number of pixels that the scanner outputs per each minimum bar width. The higher the value for R, the higher the quality of the image, but also the larger the file size. Values begin at 1000. The scanner automatically inserts a

decimal point between the first and second digit. For example, use 2500 to specify a resolution of 2.5. Set to zero when using the A and B modifiers (see [A - Output Image Width](#) and [B - Output Image Height](#) on page 230).

Example: Resolution set to 0R:

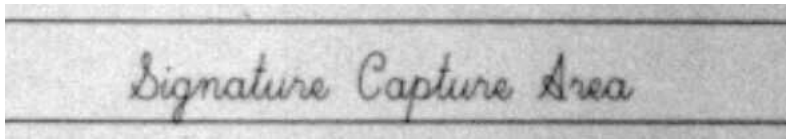

Resolution set to 1000R:



Resolution set to 2000R:

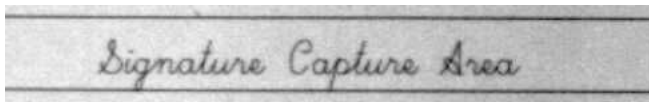

S - Barcode Aspect Ratio

All dimensions used in IMGBOX are measured as multiples of the minimum element size of the barcode. The barcode aspect ratio allows you to set the ratio of the barcode height to the narrow element width. In the example, the narrow element width is .010 inches and the barcode height is 0.400 inches, resulting in a value of $S = 0.4/0.01 = 40$.

W - Width of Signature Capture Area

The width of the signature capture area must be measured in inches divided by .01. In the example, the width of the area to be captured is 2.4 inches, resulting in a value of $W = 2.4/0.01 = 240$. (A value of 245 was used in the example to accommodate a slightly wider image area.)

Example: *IMGBOX245w37h55y.*

X - Horizontal Barcode Offset

The horizontal barcode offset allows you to offset the horizontal center of the signature capture area. Positive values move the horizontal center to the right and negative values to the left. Measurements are in multiples of the minimum bar width.

Example:

Horizontal Offset set to 75X:



Horizontal Offset set to -75X:

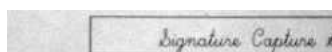

Y - Vertical Barcode Offset

The vertical barcode offset allows you to offset the vertical center of the signature capture area. Negative numbers indicate that the signature capture is above the barcode, and positive numbers indicate that the area is below the barcode. Measurements are in multiples of the minimum bar width.

Example:

Vertical Offset set to -7Y:



Vertical Offset set to 65Y:

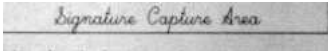

RF Default Imaging Device

The scanner supports imaging command processing (IMGSHIP, IMGSNP, IMGBOX) so that EZConfig for Scanning (see page 237) and other applications are able to perform imaging functions as if they were communicating directly with a scanner. To accomplish this, the scanner uses a menu command called RF_DID (RF Default Imaging Device). RF_DID is the name of the scanner (BT_NAM) that is to receive imaging commands. The default for RF_DID is "*" indicating that imaging commands are to be sent to all associated scanners. Change this setting to RF_DIDscanner_name to ensure that they are sent to a particular scanner. Refer to "Page" on page 54 to generate a report containing the port, work group, scanner name, and address for each scanner. Refer to "Scanner Name" on page 68 set a unique name for each scanner.

To Add a Test Code I.D. Prefix to All Symbologies

This selection allows you to turn on transmission of a Code I.D. before the decoded symbology. (See the [Symbology Charts](#), beginning on page 297 for the single character code that identifies each symbology.) This action first clears all current prefixes, then programs a Code I.D. prefix for all symbologies. This is a temporary setting that will be removed when the unit is power cycled.



PRECA2,BK2995C80!

Add Code I.D. Prefix to
All Symbologies (Temporary)

Show Software Revision

Scan the barcode below to output the current software revision, unit serial number, and other product information for both the scanner and base.



REVINF.

Show Software Revision

Test Menu

When you scan the **Test Menu On** code, then scan a programming code in this manual, the scanner displays the content of a programming code. The programming function will still occur, but in addition, the content of that programming code is output to the terminal.

Note: This feature should not be used during normal scanner operation.



TotalFreedom

TotalFreedom is an open system architecture that makes it possible for you create applications that reside on your scanner. Decoding apps and Data Formatting apps can be created using TotalFreedom. For further information about TotalFreedom, go to our website at sps.honeywell.com.

Application Plug-Ins (Apps)

Any apps that you are using can be turned off or on by scanning the following barcodes. Apps are stored in groups: Decoding, and Formatting. You can enable and disable these groups of apps by scanning that group's On or Off barcode below. You can also scan the List Apps barcode to output a list of all your apps.



Note: You must reset your device in order for the apps setting to take effect.

EZConfig for Scanning Introduction

EZConfig for Scanning provides a wide range of PC-based programming functions that can be performed on the scanner connected to your PC. EZConfig for Scanning allows you to download upgrades to the scanner's firmware, change programmed parameters, and create and print programming barcodes. Using EZConfig for Scanning, you can even save/open the programming parameters. This saved file can be e-mailed or, if required, you can create a single barcode that contains all the customized programming parameters and mail or fax that barcode to any location. Users in other locations can scan the barcode to load in the customized programming.

Configure with EZConfig for Scanning

Use the EZConfig for Scanning tool to configure your scanner online:

1. Access the Honeywell Technical Support Downloads Portal at <https://hsmftp.honeywell.com>.
2. Go to **Software > Barcode Scanners > Software > Tools and Utilities > EZConfig for Scanning > Current**.

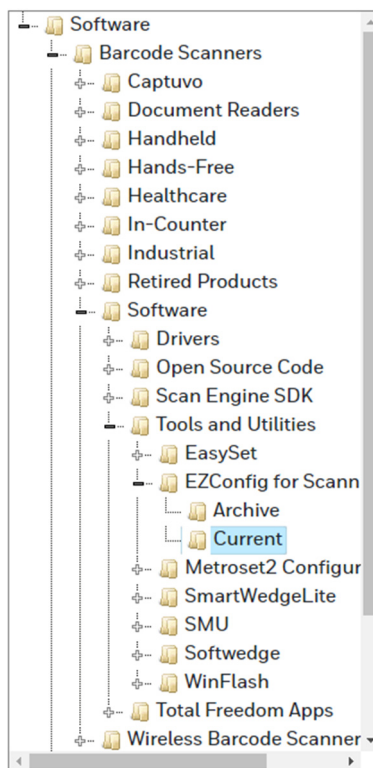

3. Download the **Setup** version of EZConfig for Scanning.
4. Open EZConfig to configure your scanner.

Reset the Factory Defaults



Caution: *This selection erases all your settings and resets the scanner to the original factory defaults. It also disables all plugins.*

If you aren't sure what programming options are in your scanner, or you've changed some options and want to restore the scanner to factory default settings, first scan the **Remove Custom Defaults** barcode, then scan **Activate Defaults**. This resets the scanner to the factory default settings.



DEFOVR.

Remove Custom Defaults



DEFAULT.

Activate Defaults

Note: *If using a cordless system, scanning the **Activate Defaults** barcode also causes both the scanner and the base or Access Point to perform a reset and become unlinked. The scanner must be placed in its base to re-establish the link before any setup codes are entered. If using an Access Point, the linking barcode must be scanned. See [Cordless System Operation](#) beginning on page 41 for additional information.*

The [Menu Commands](#), beginning on page 244, list the factory default settings for each of the commands (indicated by an asterisk (*) on the programming pages).

SERIAL PROGRAMMING COMMANDS

The serial programming commands can be used in place of the programming barcodes. Both the serial commands and the programming barcodes will program the scanner. For complete descriptions and examples of each serial programming command, refer to the corresponding programming barcode in this manual.

The device must be set to an RS232 interface (see [page 16](#)). The following commands can be sent via a PC COM port using terminal emulation software.

Conventions

The following conventions are used for menu and query command descriptions:

<i>parameter</i>	A label representing the actual value you should send as part of a command.
[<i>option</i>]	An optional part of a command.
{Data}	Alternatives in a command.
bold	Names of menus, menu commands, buttons, dialog boxes, and windows that appear on the screen.

Menu Command Syntax

Menu commands have the following syntax (spaces have been used for clarity only):

Prefix [*:Name:*] *Tag SubTag {Data}* [, *SubTag {Data}*] [*; Tag SubTag {Data}*] [...] *Storage*

Prefix Three ASCII characters: SYN M CR (ASCII 22,77,13).

:Name: This command is only used with cordless devices. It is used to specify whether you're communicating with the base or the scanner. To send information to the scanner (with the base connected to host), use **:Xenon**: The default factory setting for a Xenon XP scanner is Xenon

scanner. This setting is changed by using the BT_NAM command, which accepts alphanumeric values. If the name is not known, a wildcard (*) can be used :*

Note: *Since the base stores all work group settings and transfers to them to scanner once they are linked, changes are typically done to the base and not to the scanner.*

Tag	A 3 character case-insensitive field that identifies the desired menu command group. For example, all RS232 configuration settings are identified with a Tag of 232 .
SubTag	A 3 character case-insensitive field that identifies the desired menu command within the tag group. For example, the SubTag for the RS232 baud rate is BAD .
Data	The new value for a menu setting, identified by the Tag and SubTag.
Storage	A single character that specifies the storage table to which the command is applied. An exclamation point (!) performs the command's operation on the device's volatile menu configuration table. A period (.) performs the command's operation on the device's non-volatile menu configuration table. Use the non-volatile table only for semi-permanent changes you want saved through a power cycle.

Query Commands

Several special characters can be used to query the device about its settings.

- ^ What is the default value for the setting(s).
- > What is the PAP sub command.

Note: *When using the >, all other commands will return NAK.*

- ? What is the device's current value for the setting(s).
- * What is the range of possible values for the setting(s). (The device's response uses a dash (-) to indicate a continuous range of values. A pipe (|) separates items in a list of non-continuous values.)

:Name: Field Usage (Optional)

This command returns the query information from the scanner.

Tag Field Usage

When a query is used in place of a Tag field, the query applies to the *entire* set of commands available for the particular storage table indicated by the Storage field of the command. In this case, the SubTag and Data fields should not be used because they are ignored by the device.

SubTag Field Usage

When a query is used in place of a SubTag field, the query applies only to the subset of commands available that match the Tag field. In this case, the Data field should not be used because it is ignored by the device.

Data Field Usage

When a query is used in place of the Data field, the query applies only to the specific command identified by the Tag and SubTag fields.

Concatenation of Multiple Commands

Multiple commands can be issued within one Prefix/Storage sequence. Only the Tag, SubTag, and Data fields must be repeated for each command in the sequence. If additional commands are to be applied to the same Tag, then the new command sequence is separated with a comma (,) and only the SubTag and Data fields of the additional command are issued. If the additional command requires a different Tag field, the command is separated from previous commands by a semicolon (;).

Responses

The device responds to serial commands with one of three responses:

- ACK** Indicates a good command which has been processed.
- ENQ** Indicates an invalid Tag or SubTag command.
- NAK** Indicates the command was good, but the Data field entry was out of the allowable range for this Tag and SubTag combination, e.g., an entry for a minimum message length of 100 when the field will only accept 2 characters.

When responding, the device echoes back the command sequence with the status character inserted directly before each of the punctuation marks (the period, exclamation point, comma, or semicolon) in the command.

Examples of Query Commands

In the following examples, a bracketed notation [] depicts a non-displayable response.

Example: What is the range of possible values for Codabar Coding Enable?

Enter: **cbrena*.**

Response: **CBRENA0-1[ACK]**

This response indicates that Codabar Coding Enable (CBRENA) has a range of values from 0 to 1 (off and on).

Example: What is the default value for Codabar Coding Enable?

Enter: **cbrena^.**

Response: **CBRENA1[ACK]**

This response indicates that the default setting for Codabar Coding Enable (CBRENA) is 1, or on.

Example: What is the device's current setting for Codabar Coding Enable?

Enter: **cbrena?.**

Response: **CBRENA1[ACK]**

This response indicates that the device's Codabar Coding Enable (CBRENA) is set to 1, or on.

Example: What are the device's settings for all Codabar selections?

Enter: **cbr?.**

Response: **CBRENA1[ACK],**
 SSX0[ACK],
 CK20[ACK],
 CCT1[ACK],
 MIN2[ACK],
 MAX60[ACK],
 DFT[ACK].

This response indicates that the device's Codabar Coding Enable (CBRENA) is set to 1, or on;
the Start/Stop Character (SSX) is set to 0, or Don't Transmit;
the Check Character (CK2) is set to 0, or Not Required;
concatenation (CCT) is set to 1, or Enabled;
the Minimum Message Length (MIN) is set to 2 characters;
the Maximum Message Length (MAX) is set to 60 characters;
and the Default setting (DFT) has no value.

Trigger Commands

You can activate and deactivate the scanner with serial trigger commands. First, the scanner must be put in Manual Trigger Mode by scanning a Manual Trigger Mode barcode ([page 87](#)), or by sending a serial menu command for triggering ([page 89](#)). Once the scanner is in serial trigger mode, the trigger is activated and deactivated by sending the following commands:

Activate: **SYN T CR**

Deactivate: **SYN U CR**

The scanner scans until a barcode has been read, until the deactivate command is sent, or until the serial time-out has been reached (see [Read Time-Out](#) on page 89 for a description, and the serial command on [page 254](#)).

Reset the Custom Defaults

If you want the custom default settings restored to your scanner, scan the **Activate Custom Defaults** barcode below. This resets the scanner to the custom default settings. If there are no custom defaults, it will reset the scanner to the factory default settings. Any settings that have not been specified through the custom defaults will be defaulted to the factory default settings.



DEFAULT.

Activate Custom Defaults

Note: *If using a cordless system, scanning this barcode also causes both the scanner and the base or Access Point to perform a reset and become unlinked. The scanner must be placed in its base to re-establish the link. If using an Access Point, the linking barcode must be scanned. See [Cordless System Operation](#) beginning on page 41 for additional information.*

The charts on the following pages list the factory default settings for each of the commands (indicated by an asterisk (*) on the programming pages).

Menu Commands

Selection	Setting * Indicates default	Serial Command # Indicates a numeric entry	Page
Product Default Settings			
Set Custom Defaults	Set Custom Defaults	MNUCDP	13
	Save Custom Defaults	MNUCDS	13
Reset the Custom Defaults	Activate Custom Defaults	DEFAULT	13
Reset the Factory Defaults - cordless scanners	Factory Default Settings: All Application Groups	PAPDFT&	70
Reset the Custom Defaults - cordless scanners	Custom Default Settings: All Application Groups	PAPDFT	71
Program the Interface			
Plug and Play Codes	Keyboard Wedge: IBM PC AT and Compatibles with CR suffix	PAP_AT	15
	Laptop Direct Connect with CR suffix	PAPLTD	16
	RS232 Serial Port	PAP232	16
Plug and Play Codes: RS485	IBM Port 5B Interface	PAPP5B	16
	IBM Port 9B HHBCR-1 Interface	PAP9B1	16
	IBM Port 17 Interface	PAPP17	17
	IBM Port 9B HHBCR-2 Interface	PAP9B2	17
Plug and Play Codes: IBM SurePos	USB IBM SurePos Handheld	PAPSPH	17
	USB IBM SurePos Tabletop	PAPSPT	17
Plug and Play Codes: USB	USB Keyboard (PC)	PAP124	18
	USB Keyboard (Mac)	PAP125	18
	USB Japanese Keyboard (PC)	TRMUSB134	18
	USB HID	PAP131	18
	USB Serial	TRMUSB130	18
	CTS/RTS Emulation On	USBCTS1	19
	*CTS/RTS Emulation Off	USBCTS0	19
	ACK/NAK Mode On	USBACK1	19
	*ACK/NAK Mode Off	USBACK0	19
Plug and Play Codes	Verifone Ruby Terminal	PAPRBY	19
	Gilbarco Terminal	PAPGLB	20
	Honeywell Bioptic Aux Port	PAPBIO	20
	Datalogic Magellan Aux Port	PAPMAG	20
	Wincor Nixdorf Terminal	PAPWNX	21
	Wincor Nixdorf Beetle	PAPBTL	21

Selection	Setting * Indicates default	Serial Command # Indicates a numeric entry	Page
	Wincor Nixdorf RS232 Mode A	PAPWMA	22
Program Keyboard Country	*U.S.A.	KBDCTY0	22
	Albania	KBDCTY35	22
	Azeri (Cyrillic)	KBDCTY81	22
	Azeri (Latin)	KBDCTY80	22
	Belarus	KBDCTY82	23
	Belgium	KBDCTY1	23
	Bosnia	KBDCTY33	23
	Brazil	KBDCTY16	23
	Brazil (MS)	KBDCTY59	23
	Bulgaria (Cyrillic)	KBDCTY52	23
	Bulgaria (Latin)	KBDCTY53	23
	Canada (French legacy)	KBDCTY54	23
	Canada (French)	KBDCTY18	23
	Canada (Multilingual)	KBDCTY55	23
	Croatia	KBDCTY32	23
	Czech	KBDCTY15	23
	Czech (Programmers)	KBDCTY40	24
	Czech (QWERTY)	KBDCTY39	24
	Czech (QWERTZ)	KBDCTY38	24
	Denmark	KBDCTY8	24
	Dutch (Netherlands)	KBDCTY11	24
	Estonia	KBDCTY41	24
	Faroese	KBDCTY83	24
	Finland	KBDCTY2	24
	France	KBDCTY3	24
	Gaelic	KBDCTY84	24
	Germany	KBDCTY4	24
	Greek	KBDCTY17	24
	Greek (220 Latin)	KBDCTY64	25
	Greek (220)	KBDCTY61	25
	Greek (319 Latin)	KBDCTY65	25
	Greek (319)	KBDCTY62	25
	Greek (Latin)	KBDCTY63	25
Greek (MS)	KBDCTY66	25	
Greek (Polytonic)	KBDCTY60	25	
Hebrew	KBDCTY12	25	

Selection	Setting * Indicates default	Serial Command # Indicates a numeric entry	Page
	Hungarian (101 key)	KBDCTY50	25
	Hungary	KBDCTY19	25
	Iceland	KBDCTY75	25
	Irish	KBDCTY73	25
	Italian (142)	KBDCTY56	26
	Italy	KBDCTY5	26
	Japan ASCII	KBDCTY28	26
	Kazakh	KBDCTY78	26
	Kyrgyz (Cyrillic)	KBDCTY79	26
	Latin America	KBDCTY14	26
	Latvia	KBDCTY42	26
	Latvia (QWERTY)	KBDCTY43	26
	Lithuania	KBDCTY44	26
	Lithuania (IBM)	KBDCTY45	26
	Macedonia	KBDCTY34	26
	Malta	KBDCTY74	26
	Mongolian (Cyrillic)	KBDCTY86	27
	Norway	KBDCTY9	27
	Poland	KBDCTY20	27
	Polish (214)	KBDCTY57	27
	Polish (Programmers)	KBDCTY58	27
	Portugal	KBDCTY13	27
	Romania	KBDCTY25	27
	Russia	KBDCTY26	27
	Russian (MS)	KBDCTY67	27
	Russian (Typewriter)	KBDCTY68	27
	SCS	KBDCTY21	27
	Serbia (Cyrillic)	KBDCTY37	27
	Serbia (Latin)	KBDCTY36	28
	Slovakia	KBDCTY22	28
	Slovakia (QWERTY)	KBDCTY49	28
	Slovakia (QWERTZ)	KBDCTY48	28
	Slovenia	KBDCTY31	28
	Spain	KBDCTY10	28
	Spanish variation	KBDCTY51	28
	Sweden	KBDCTY23	28
	Switzerland (French)	KBDCTY29	28

Selection	Setting * Indicates default	Serial Command # Indicates a numeric entry	Page
	Switzerland (German)	KBDCTY6	28
	Tatar	KBDCTY85	28
	Turkey F	KBDCTY27	28
	Turkey Q	KBDCTY24	29
	Ukrainian	KBDCTY76	29
	United Kingdom	KBDCTY7	29
	United Stated (Dvorak right)	KBDCTY89	29
	United States (Dvorak left)	KBDCTY88	29
	United States (Dvorak)	KBDCTY87	29
	United States (International)	KBDCTY30	29
	Uzbek (Cyrillic)	KBDCTY77	29
ALT Mode	* Off	KBDALTO	30
	3 Characters	KBDALT6	30
	4 Characters	KBDALT7	30
Keyboard Style	*Regular	KBDSTY0	30
	Caps Lock	KBDSTY1	30
	Shift Lock	KBDSTY2	30
	Automatic Caps Lock	KBDSTY6	31
	Autocaps via Num Lock	KBDSTY7	31
	Emulate External Keyboard	KBDSTY5	31
Keyboard Conversion	*Keyboard Conversion Off	KBDCNV0	31
	Convert all Characters to Upper Case	KBDCNV1	32
	Convert all Characters to Lower Case	KBDCNV2	32
Control Character Output	*Control Character Output Off	KBDNPE0	32
	Control Character Output On	KBDNPE1	32

Selection	Setting * Indicates default	Serial Command # Indicates a numeric entry	Page
Keyboard Modifiers	*Control + X Off	KBDCAS0	33
	DOS Mode Control + X	KBDCAS1	33
	Windows Mode Control + X	KBDCAS2	33
	Windows Mode Prefix/Suffix Off	KBDCAS3	33
	DOS Mode Control + X Mode On with Windows Mode Prefix/Suffix	KBDCAS4	33
	Supports ALT 3 Digit HEX Mode	KBDCAS5	33
	*Turbo Mode Off	KBDTMD0	33
	Turbo Mode On	KBDTMD1	33
	*Numeric Keypad Off	KBDNPS0	33
	Numeric Keypad On	KBDNPS1	33
	*Auto Direct Connect Off	KBDADC0	34
	Auto Direct Connect On	KBDADC1	34
Baud Rate	300 BPS	232BAD0	34
	600 BPS	232BAD1	34
	1200 BPS	232BAD2	34
	2400 BPS	232BAD3	34
	4800 BPS	232BAD4	34
	9600 BPS	232BAD5	35
	19200 BPS	232BAD6	35
	38400 BPS	232BAD7	35
	57600 BPS	232BAD8	35
	*115200 BPS	232BAD9	35
Word Length: Data Bits, Stop Bits, and Parity	7 Data, 1 Stop, Parity Even	232WRD3	35
	7 Data, 1 Stop, Parity None	232WRD0	35
	7 Data, 1 Stop, Parity Odd	232WRD6	35
	7 Data, 2 Stop, Parity Even	232WRD4	35
	7 Data, 2 Stop, Parity None	232WRD1	35
	7 Data, 2 Stop, Parity Odd	232WRD7	36
	8 Data, 1 Stop, Parity Even	232WRD5	36
	*8 Data, 1 Stop, Parity None	232WRD2	36
	8 Data, 1 Stop, Parity Odd	232WRD8	36
	8 Data, 1 Stop, Parity Mark	232WRD14	36
RS232 Receiver Time-out	Range 0 - 300 seconds *0	232LPT###	36

Selection	Setting * Indicates default	Serial Command # Indicates a numeric entry	Page
RS232 Handshaking	*RTS/CTS Off	232CTS0	37
	Flow Control, No Timeout	232CTS1	37
	Two-Direction Flow Control	232CTS2	37
	Flow Control with Timeout	232CTS3	37
	RS232 Timeout (1-5100 milliseconds)	232DEL####	37
	*XON/XOFF Off	232XON0	38
	XON/XOFF On	232XON1	37
	*ACK/NAK Off	232ACK0	38
	ACK/NAK On	232ACK1	38
Scanner-Bioptic Packet Mode	*Packet Mode Off	232PKT0	38
	Packet Mode On	232PKT2	38
Scanner-Bioptic ACK/NAK Mode	*Bioptic ACK/NAK Off	232NAK0	39
	Bioptic ACK/NAK On	232NAK1	39
Scanner-Bioptic ACK/NAK Timeout	ACK/NAK Timeout (1-30000 milliseconds) *5100	232DLK#####	39
Cordless System Operation			
Replace a Linked Scanner	Override locked Scanner (Single Scanner)	BT_RPL1	42
Temporary Streaming Presentation Mode	*Temporary Streaming Presentation Mode On	BEPPGE2	46
	*10 Second Timeout	TRGTPM10000	46
	30 Second Timeout	TRGTPM30000	46
Presentation Mode in Base	*Disabled	BT_PIB0	46
	Enabled	BT_PIB1	46
Base Power Communication Indicator	*On	:::BASRED1	50
	Off	:::BASREDO	50
Low Power Alerts	*Low Power Alert 10-30%	LPIRAGO	51
	Low Power Alert 10-50%	LPIRAG1	51
	Low Power Alert Flash Number (1-9) *3	LPIFNO#	51
	Interval Between Flashes (1-9) *2	LPIFDL#	51
	Low Power Alert Repeat (1-5) *1	LPL_NO#	51
	Interval Between Alerts (10-120) *10	LPL_DL###	52
	Low Power Alert Beep Off	LPIBEP0	52
	*Low Power Alert Beep On	LPIBEP1	52
Reset Scanner	Reset Scanner	RESET_	52

Selection	Setting * Indicates default	Serial Command # Indicates a numeric entry	Page
Scan While in Base Cradle	Scan in Cradle Off (CCB-H-010BT default)	BT_SIC0	53
	Scan in Cradle On (CCB01-010BT default)	BT_SIC1	53
	Shut Down Scanner in Cradle	BT_SIC2	53
Base Charge Modes	Base Charge Off	BTRCHG0	53
	*External or Interface Cable Power	BTRCHG1	54
	External Power Only	BTRCHG2	54
Page Mode	*On	BEPPGE1	54
	Off	BEPPGE0	54
Page Pitch	*Low (1000 Hz)	BEPPFQ1000	54
	Medium (3250 Hz)	BEPPFQ3250	55
	High (4200 Hz)	BEPPFQ4200	55
Beeper Pitch - Base Error	*Low/Razz (250 Hz) (min 200 Hz)	BASFQ2250	55
	Medium (3250 Hz)	BASFQ23250	55
	High (4200 Hz) (max 9000 Hz)	BASFQ24200	55
Number of Beeps - Base Error	*1 (Range 1 - 9)	BASERR#	55
Scanner Report	Scanner Report	RPTSCN	56
Scanner Address	Scanner Address	BT_LDA	56
Base Address	Base Address	BASLDA	56
Scanner Modes	Charge Only Mode	BASLNK0	57
	*Charge and Link Mode	BASLNK1	57
	Locked Link Mode	BASCON0,DNG1	58
	*Open Link Mode	BASCON1,DNG1	58
	Unlink Scanner	BT_RMV	58
	Override Locked Scanner	BT_RPL1	58
Out-of-Range Alarm	Base Alarm Duration (Range 1 - 3000 sec) *0	BASORD####	59
	Scanner Alarm Duration (Range 1 - 3000 sec) *0	BT_ORD####	59
Alarm Sound Type	Base Alarm Type (0-7) *0	BASORW#	59
	Scanner Alarm Type (0-7) *0	BT_ORW#	59
Scanner Power Time-Out Timer	0 Seconds	BT_LPT0	60
	200 Seconds	BT_LPT200	60
	400 Seconds	BT_LPT400	60
	900 Seconds	BT_LPT900	60
	*3600 Seconds	BT_LPT3600	60
	7200 Seconds	BT_LPT7200	60

Selection	Setting * Indicates default	Serial Command # Indicates a numeric entry	Page
Flexible Power Management for Xenon XP 1952g/1952h	*Full Power (100%)	BT_TXP100	61
	Medium Power (35%)	BT_TXP35	61
	Medium Low Power (5%)	BT_TXP5	61
	Low Power (1%)	BT_TXP1	61
Flexible Power Management for Xenon XP 1952g-BF/1952h-BF	*Full Power (100%)	BT_TXP8	62
	Medium High Power (87%)	BT_TXP7	62
	Medium Power (50%)	BT_TXP4	62
	Low Power (1%)	BT_TXP1	62
Batch Mode	Automatic Batch Mode	BATENA1	63
	*Batch Mode Off	BATENA0	63
	Inventory Batch Mode	BATENA2	63
	Persistent Batch Mode	BATENA3	63
Batch Mode Beep	Off	BATBEPO	63
	*On	BATBEP1	63
Batch Mode Storage	*Flash Storage	BATNVS1	64
	RAM Storage	BATNVS0	64
Batch Mode Quantity	*Off	BATQTY0	64
	On	BATQTY1	64
Quantity Codes	0	BATNUM0	65
	*1	BATNUM1	65
	2	BATNUM2	65
	3	BATNUM3	65
	4	BATNUM4	66
	5	BATNUM5	66
	6	BATNUM6	66
	7	BATNUM7	66
	8	BATNUM8	66
Batch Mode Output Order	*FIFO	BATLIFO	66
	LIFO	BATLIF1	66
Total Records	Total Records	BATNRC	66
Delete Last Code	Delete Last Code	BATUND	67
Clear All Codes	Clear All Codes	BATCLR	67
Transmit Records to Host	Transmit Inventory Records	BAT_TX	67

Selection	Setting * Indicates default	Serial Command # Indicates a numeric entry	Page
Batch Mode Transmit Delay	*Off (No Delay)	BATDLY0	67
	Short (250 ms)	BATDLY250	67
	Medium (500 ms)	BATDLY500	68
	Long (1000 ms)	BATDLY1000	68
Multiple Scanner Operation	Multiple Scanner Operation	BASCON2,DNG3	68
Scanner Name	0001	BT_NAM0001	69
	0002	BT_NAM0002	69
	0003	BT_NAM0003	69
	Reset	RESET_	69
	Scanner Name	BT_NAM	69
Application Work Group Selections	*Group 0	GRPSELO	70
	Group 1	GRPSEL1	70
	Group 2	GRPSEL2	70
Reset the Factory Defaults: All Application Work Groups	Factory Default Settings: All Work Groups	PAPDFT&	70
Reset the Custom Defaults: All Application Work Groups	Custom Default Settings: All Work Groups	PAPDFT	71
Bluetooth Connection	*Bluetooth SSP On	BT_SSP1	71
	Bluetooth SSP Off	BT_SSP0	71
	Bluetooth HID Keyboard Connect	PAPBTH	72
	Bluetooth HID Japanese Keyboard Connect	PAPJKB	72
	Bluetooth HID Keyboard Disconnect	PAPSP	74
Pair with Bluetooth Low Energy (BLE) Devices	HID BLE Connect	PAPLEH	74
	Serial BLE Connect	PAPTIO	74
Bluetooth Serial Port - PCs/ Laptops	Non-Base BT Connection	BT_TRM0;BT_DNG5	74
PDA's/Mobility Systems Devices	BT Connection - PDA/Mobility Systems Device	BT_TRM0;BT_DNG1	74
Change the Scanner's Bluetooth PIN Code	Bluetooth PIN Code	BT_PIN	75
Auto Reconnect Mode	*Auto Reconnect On	BT_ACM1	75
	Auto Reconnect Off	BT_ACM0	75
Maximum Link Attempts	Maximum Link Attempts (0-100) *0	BT_MLA###	76
Relink Time-Out	Relink Time-Out (1-100) *3	BT_RLT###	77

Selection	Setting * Indicates default	Serial Command # Indicates a numeric entry	Page
Host Command Acknowledgment	Host ACK On	HSTACK1	79
	*Host ACK Off	HSTACK0	79
	Host ACK Timeout (1-90) *10	HSTATO##	80
Input/Output Selections			
Power Up Beeper	Power Up Beeper Off - Scanner	BEPPWR0	81
	*Power Up Beeper On - Scanner	BEPPWR1	81
	Power Up Beeper Off - Cordless Base	BASPWR0	81
	Power Up Beeper On - Cordless Base	BASPWR1	81
Beep on BEL Character	Beep on BEL On	BELBEP1	82
	*Beep on BEL Off	BELBEP0	82
Trigger Click	On	BEPTRG1	82
	*Off	BEPTRG0	82
Beeper - Good Read	Off	BEPBEP0	82
	*On	BEPBEP1	82
Beeper Volume - Good Read	Off	BEPLVLO	82
	*Low (Default-Xenon XP healthcare)	BEPLVL1	83
	Medium	BEPLVL2	83
	*High (Default - Xenon XP)	BEPLVL3	83
Beeper Pitch - Good Read (Frequency)	Low (1600 Hz) (min 400 Hz)	BEPFQ11600	83
	*Medium (2700 Hz)	BEPFQ12700	83
	High (4200 Hz) (max 9000 Hz)	BEPFQ14200	83
Vibrate - Good Read	*Vibrate - Good Read Off	TFBGRD0	84
	Vibrate - Good Read On	TFBGRD1	84
Vibrate Duration	Duration (100 - 2,000 ms) *100	TFBDUR####	84
Beeper Pitch - Error (Frequency)	*Razz (250 Hz) (min 200 Hz)	BEPFQ2800	84
	Medium (3250 Hz)	BEPFQ23250	84
	High (4200 Hz) (max 9000 Hz)	BEPFQ24200	84
Beeper Duration - Good Read	*Normal Beep	BEPBIP0	85
	Short Beep	BEPBIP1	85
LED - Good Read	Off	BEPLED0	85
	*On	BEPLED1	85
Number of Beeps - Good Read	(Range 1 - 9) *1	BEPRPT#	85
Number of Beeps - Error	(Range 1 - 9) *1	BEPERR#	85

Selection	Setting * Indicates default	Serial Command # Indicates a numeric entry	Page
Good Read Delay	*No Delay	DLYGRD0	86
	Short Delay (500 ms)	DLYGRD500	86
	Medium Delay (1000 ms)	DLYGRD1000	86
	Long Delay (1500 ms)	DLYGRD1500	86
User-Specified Good Read Delay	Range 0 - 30,000 ms	DLYGRD#####	86
Trigger Modes	*Manual Trigger - Normal	PAPHHF	87
	Manual Trigger - Enhanced	PAPHHS	87
Trigger Toggle	*Trigger Toggle Off	TRGTGM0	87
	Trigger Toggle - Image Capture	TRGTGM1	87
	Trigger Toggle Off - Centering	TRGTGM3	87
Trigger Number	2 Quick Triggers	TRGTPC2	88
	3 Quick Triggers	TRGTPC3	88
	4 Quick Triggers	TRGTPC4	88
Trigger Timing	Trigger Timing (Range 50 - 2000) *400	TRGTTI#####	88
Trigger Toggle Timeout	Trigger Toggle Timeout (Range 0 - 65) *5	TRGTGT##	88
Serial Trigger Mode	Read Time-Out (0 - 300,000 ms) *30,000	TRGSTO#####	89
Presentation Mode	Presentation Mode	PAPTPR	89
Triggered Presentation Mode	Ambient Light Only	PDCLED0	90
	*Ambient and Scanner Light	PDCLED1	90
Presentation LED Behavior After Decode	*LEDs On	TRGPCK1	90
	LEDs Off	TRGPCK0	90
Presentation Centering Window	Presentation Centering On	PDCWIN1	91
	*Presentation Centering Off	PDCWIN0	91
	Left of Presentation Centering Window (*40%)	PDCLFT###	92
	Right of Presentation Centering Window (*60%)	PDCRGT###	92
	Top of Presentation Centering Window (*40%)	PDCTOP###	91
	Bottom of Presentation Centering Window (*60%)	PDCBOT###	91
In-Stand Sensor Mode	*Sensor On	TRGSSW1	92
	Sensor Off	TRGSSW0	92

Selection	Setting * Indicates default	Serial Command # Indicates a numeric entry	Page
Poor Quality Codes	Poor Quality 1D Reading On	DECLDI1	92
	*Poor Quality 1D Reading Off	DECLDIO	93
	*Poor Quality PDF Reading On	PDFXPR10	92
	Poor Quality PDF Reading Off	PDFXPRO	93
	Low Resolution PDF Codes On	PDFDMI1	93
	*Low Resolution PDF Codes Off	PDFDMIO	93
CodeGate	*CodeGate Off Out-of-Stand	AOSCGD0.	94
	CodeGate On Out-of-Stand	AOSCGD1.	94
Streaming Presentation	Streaming Presentation Mode - Normal	PAPSPN	94
	Streaming Presentation Mode - Enhanced	PAPSPE	94
Hands Free Time-Out	Range (0 - 300,000 ms) 5000 ms	TRGPT0#####	95
Reread Delay	Short (500 ms)	DLYRRD500	95
	*Medium (750 ms)	DLYRRD750	95
	Long (1000 ms)	DLYRRD1000	95
	Extra Long (2000 ms)	DLYRRD2000	95
User-Specified	Range 0 - 30,000 ms	DLYRRD#####	96
2D Reread Delay	*2D Reread Delay Off	DLY2RRO	96
	Short (1000ms)	DLY2RR1000	96
	Medium (2000ms)	DLY2RR2000	96
	Long (3000ms)	DLY2RR3000	96
	Extra Long (4000ms)	DLY2RR4000	96
Character Activation Mode	*Off	HSTCEN0	97
	On	HSTCEN1	97
	Activation Character (Range 0-255) *12 [DC2]	HSTACH###	97
	Do Not End Character Activation After Good Read	HSTCGD0	97
	End Character Activation After Good Read	HSTCGD1	98
	Character Activation Timeout (Range 1 - 300,000) *30,000 ms	HSTCDT#####	98
Character Deactivation Mode	*Off	HSTDEN0	98
	On	HSTDEN1	98
	Deactivation Character (Range 0-255) *14 [DC4]	HSTDCH###	98
Illumination Lights	*Lights On	SCNLED1	99
	Lights Off	SCNLED0	99

Selection	Setting * Indicates default	Serial Command # Indicates a numeric entry	Page
Aimer Delay	1 millisecond	SCNDLY1	99
	250 milliseconds	SCNDLY250	99
	500 milliseconds	SCNDLY500	99
	*Off (no delay)	SCNDLY0	99
User-Specified Aimer Delay	Range 0 - 4,000 ms	SCNDLY####	100
Aimer Mode	Off	SCNAIM0	100
	*Interlaced	SCNAIM2	100
Single Code Centering	Single Code Centering	DECWIN1;DECTOP49;DECBOT 51;DECRGT51;DECLFT49	101
Centering Window	Centering On	DECWIN1	102
	*Centering Off	DECWIN0	102
	Left of Centering Window (*40%)	DECLFT###	102
	Right of Centering Window (*60%)	DECRGT###	102
	Top of Centering Window (*40%)	DECTOP###	102
	Bottom of Centering Window (*60%)	DECBOT###	102
Preferred Symbology	On	PRFENA1	103
	*Off	PRFENA0	103
	High Priority Symbology	PRFCOD##	103
	Low Priority Symbology	PRFBLK##	103
	Preferred Symbology Timeout (Range 100-3000) *500	PRFPTO####	104
	Preferred Symbology Default	PRFDFT	104
Output Sequence Editor	Enter Output Sequence	SEQBLK	105
	Add Prefix to Complete Output Sequences	SEQPRE	105
	Add Suffix to Complete Output Sequences	SEQSUF	105
	Add Separators to Complete Output Sequences	SEQSEP	105
	Terminate String	FF	105
Partial Sequence	Transmit Partial Output Sequence	SEQTTS1	105
	Add Prefix to Partial Output Sequences	SEQIPR	105
	Add Suffix to Partial Output Sequences	SEQISU	105
	Add Separators to Partial Output Sequences	SEQISE	105
	Terminate String	FF	105
	Define Satisfactory Subsets	SEQSAT	105

Selection	Setting * Indicates default	Serial Command # Indicates a numeric entry	Page
	Timeout for SEQSAT	SEQTIM	105
	*Discard Partial Output Sequence	SEQTTS0	111
	Default Output Sequence	SEQDFT	113
Require Output Sequence	Required	SEQ_EN2	113
	On/Not Required	SEQ_EN1	113
	*Off	SEQ_EN0	113
Good Read Tone - Output Sequences	Good Read Beep - Each Code in Sequence	BEPSIN0	114
	*Good Read Click - Each Code in Sequence	BEPSIN1	114
	Good Read Beep - Partial Sequence Output	BEPISE0	114
	*Error Tone - Partial Sequence Output	BEPISE1	114
Multiple Symbols	On	SHOTGN1	114
	*Off	SHOTGN0	114
No Read	On	SHWNRD1	115
	*Off	SHWNRD0	115
Video Reverse	Video Reverse Only	VIDREV1	115
	Video Reverse and Standard Barcodes	VIDREV2	115
	*Video Reverse Off	VIDREVO	116
Working Orientation	*Upright	ROTATN0	116
	Vertical, Bottom to Top (Rotate CCW 90°)	ROTATN1	116
	Upside Down	ROTATN2	116
	Vertical, Top to Bottom (Rotate CW 90°)	ROTATN3	116
Healthcare Selections			
Quiet Operations - Combination Codes	Silent Mode with Flashing LED - Cordless Scanner and Base	bepfn5;bepfr50;beppar0;basplr0;beppwr0;baslv0;bepvl0;be pbip0;bepFQ12700;beplot0.	117
	Silent Mode with Flashing LED - Corded Scanner	bepfn5;bepfr50;beppwr0;bepvl0;bepbip0;bepFQ12700;beplot0.	117
	Silent Mode with Long LED - Cordless Scanner and Base	bepfn0;bepfr10;beppar0;basplr0;beppwr0;baslv0;bepvl0;be pbip0;bepFQ12700;beplot1.	118
	Silent Mode with Long LED - Corded Scanner	bepfn0;bepfr10;beppwr0;bepvl0;bepbip0;bepFQ12700;beplot1.	118

Selection	Setting * Indicates default	Serial Command # Indicates a numeric entry	Page
	Very Low Beeper (Nighttime Mode) - Cordless Scanner and Base	bepfn0;bepfr10;beppar0;baspwr0;beppwr1;baslv1;beplv1;bepbip1;bepFQ14200;beplot0.	118
	Very Low Beeper (Nighttime Mode) - Corded Scanner	bepfn0;bepfr10;beppwr1;beplv1;bepbip1;bepFQ14200;beplot0.	118
	Low Beeper (Daytime Mode) - Cordless Scanner and Base	bepfn0;bepfr10;beppar1;baspwr1;beppwr1;baslv1;beplv1;bepbip0;bepFQ12700;beplot0.	119
	Low Beeper (Daytime Mode) - Corded Scanner	bepfn0;bepfr10;beppwr1;beplv1;bepbip0;bepFQ12700;beplot0.	119
Quiet Operations - LED and Volume Settings			
Linking LED Colors and Sound	*Green LED Flashes/Sound	BEPPAR1	119
	Red LED Flashes/Silent	BEPPAR0	119
Number of LED Flashes	*1 LED Flash	BEPLFN0	120
	5 LED Flashes	BEPLFN5	120
	10 LED Flashes	BEPLFN10	120
	25 LED Flashes	BEPLFN25	120
LED Flash Rate	*Fast Flash	BEPLFR50	120
	Medium Flash	BEPLFR250	120
	Slow Flash	BEPLFR500	120
LED Solid (No Flash)	*LED Solid Off (Resume Flash)	BEPLOT0	121
	LED Solid 1 Second	BEPLOT1	121
	LED Solid 3 Seconds	BEPLOT3	121
	LED Solid 5 Seconds	BEPLOT5	121
Page Volume Control	Page Volume Off	BEPPGV0	121
	*Page Volume Low	BEPPGV1	121
	Page Volume Medium	BEPPGV2	122
	Page Volume High	BEPPGV3	122
Out-of-Range Alarm Volume	Base Alarm Volume Off	BASORV0	122
	Scanner Alarm Volume Off	BT_ORV0	122
	*Base Alarm Volume Low	BASORV1	122
	*Scanner Alarm Volume Low	BT_ORV1	122
	Base Alarm Volume Medium	BASORV2	122
	Scanner Alarm Volume Medium	BT_ORV2	123
	Base Alarm Volume High	BASORV3	123
	Scanner Alarm Volume High	BT_ORV3	123
Out-of-Range Delay	Out-of-Range Delay (Range 0-3000) *0	BT_ORY####	123

Selection	Setting * Indicates default	Serial Command # Indicates a numeric entry	Page
Prefix/Suffix Selections			
Add CR Suffix to All Symbologies		VSUF <code>CR</code>	127
Prefix	Add Prefix	PREBK2##	127
	Clear One Prefix	PRECL2	127
	Clear All Prefixes	PRECA2	127
Suffix	Add Suffix	SUFBK2##	127
	Clear One Suffix	SUFCL2	127
	Clear All Suffixes	SUFCA2	127
Function Code Transmit	*Enable	RMVFNC0	128
	Disable	RMVFNC1	128
Intercharacter Delay	Range 0 - 5000 (5ms increments)	DLYCHR####	128
User Specified Intercharacter Delay	Delay Length 0 - 5000 (5ms increments)	DLYCRX####	129
	Character to Trigger Delay	DLY_XX##	129
Interfunction Delay	Range 0 - 5000 (5ms increments)	DLYFNC####	129
Intermessage Delay	Range 0 - 5000 (5ms increments)	DLYMSG####	130
Data Formatter Selections			
Data Format Editor	*Default Data Format (None)	DFMDF3	132
	Show Data Format Settings	DFMBK3?	132
	Enter Data Format	DFMBK3##	133
	Clear One Data Format	DFMCL3	133
	Clear All Data Formats	DFMCA3	133
Data Formatter	Data Formatter Off	DFM_EN0	147
	*Data Formatter On, Not Required, Keep Prefix/Suffix	DFM_EN1	148
	Data Format Required, Keep Prefix/Suffix	DFM_EN2	148
	Data Formatter On, Not Required, Drop Prefix/Suffix	DFM_EN3	148
	Data Format Required, Drop Prefix/Suffix	DFM_EN4	148
Data Format Non-Match Error Tone	*Data Format Non-Match Error Tone On	DFMDECO	148
	Data Format Non-Match Error Tone Off	DFMDEC1	149

Selection	Setting * Indicates default	Serial Command # Indicates a numeric entry	Page
Primary/Alternate Data Formats	Primary Data Format	ALTFNM0	149
	Data Format 1	ALTFNM1	149
	Data Format 2	ALTFNM2	149
	Data Format 3	ALTFNM3	149
Single Scan Data Format Change	Single Scan-Primary Data Format	VSAF_0	149
	Single Scan-Data Format 1	VSAF_1	150
	Single Scan-Data Format 2	VSAF_2	150
	Single Scan-Data Format 3	VSAF_3	150
Symbologies			
All Symbologies	All Symbologies Off	ALLENA0	152
Codabar	Default All Codabar Settings	CBRDFT	152
	Off	CBRENA0	152
	*On	CBRENA1	152
Codabar Start/Stop Char.	*Don't Transmit	CBRSSX0	153
	Transmit	CBRSSX1	153
Codabar Check Char.	*No Check Char.	CBRCK20	153
	Validate, But Don't Transmit	CBRCK21	153
	Validate, and Transmit	CBRCK22	153
Codabar Concatenation	*Off	CBRCCT0	154
	On	CBRCCT1	154
	Require	CBRCCT2	154
Codabar Message Length	Minimum (2 - 60) *4	CBRMIN##	154
	Maximum (2 - 60) *60	CBRMAX##	154
Code 39	Default All Code 39 Settings	C39DFT	155
	Off	C39ENA0	155
	*On	C39ENA1	155
Code 39 Start/Stop Char.	*Don't Transmit	C39SSX0	155
	Transmit	C39SSX1	155
Code 39 Check Char.	*No Check Char.	C39CK20	155
	Validate, But Don't Transmit	C39CK21	155
	Validate, and Transmit	C39CK22	155
Code 39 Message Length	Minimum (0 - 48) *0	C39MIN##	156
	Maximum (0 - 48) *48	C39MAX##	156

Selection	Setting * Indicates default	Serial Command # Indicates a numeric entry	Page
Code 39 Append	*Off	C39APPO	156
	On	C39APP1	156
Code 32 Pharmaceutical (PARAF)	*Off	C39B320	157
	On	C39B321	157
Code 39 Full ASCII	*Off	C39ASCO	157
	On	C39ASC1	157
	Code 39 Code Page	C39DCP	157
Interleaved 2 of 5	Default All Interleaved 2 of 5 Settings	I25DFT	158
	Off	I25ENAO	158
	*On	I25ENA1	158
Interleaved 2 of 5 Check Digit	*No Check Digit	I25CK20	158
	Validate, But Don't Transmit	I25CK21	158
	Validate and Transmit	I25CK22	158
Interleaved 2 of 5 Message Length	Minimum (2 - 80) *4	I25MIN##	159
	Maximum (2 - 80) *80	I25MAX##	159
	*FEBRABAN Decode Off	I25PAY0	159
	FEBRABAN Decode On	I25PAY1	159
NEC 2 of 5	Default All NEC 2 of 5 Settings	N25DFT	160
	Off	N25ENAO	160
	*On	N25ENA1	160
NEC 2 of 5 Check Digit	*No Check Digit	N25CK20	160
	Validate, But Don't Transmit	N25CK21	160
	Validate and Transmit	N25CK22	160
NEC 2 of 5 Message Length	Minimum (2 - 80) *4	N25MIN##	161
	Maximum (2 - 80) *80	N25MAX##	161
Code 93	Default All Code 93 Settings	C93DFT	161
	Off	C93ENAO	161
	*On	C93ENA1	161
Code 93 Message Length	Minimum (0 - 80) *0	C93MIN##	161
	Maximum (0 - 80) *80	C93MAX##	161
Code 93 Append	On	C93APP1	162
	*Off	C93APPO	162
Code 93 Code Page	Code 93 Code Page	C93DCP	162

Selection	Setting * Indicates default	Serial Command # Indicates a numeric entry	Page
Straight 2 of 5 Industrial	Default All Straight 2 of 5 Industrial Settings	R25DFT	163
	*Off	R25ENAO	163
	On	R25ENA1	163
Straight 2 of 5 Industrial Message Length	Minimum (1 - 48) *4	R25MIN##	163
	Maximum (1 - 48) *48	R25MAX##	163
Straight 2 of 5 IATA	Default All Straight 2 of 5 IATA Settings	A25DFT	164
	*Off	A25ENAO	164
	On	A25ENA1	164
Straight 2 of 5 IATA Redundancy	Range (0 - 10) *0	A25VOT##	164
Straight 2 of 5 IATA Message Length	Minimum (1 - 48) *4	A25MIN##	164
	Maximum (1 - 48) *48	A25MAX##	164
Matrix 2 of 5	Default All Matrix 2 of 5 Settings	X25DFT	165
	*Off	X25ENAO	165
	On	X25ENA1	165
Matrix 2 of 5 Message Length	Minimum (1 - 80) *4	X25MIN##	165
	Maximum (1 - 80) *80	X25MAX##	165
Code 11	Default All Code 11 Settings	C11DFT	166
	*Off	C11ENAO	166
	On	C11ENA1	166
Code 11 Check Digits Required	1 Check Digit	C11CK20	166
	*2 Check Digits	C11CK21	166
Code 11 Message Length	Minimum (1 - 80) *4	C11MIN##	166
	Maximum (1 - 80) *80	C11MAX##	166
Code 128	Default All Code 128 Settings	128DFT	167
	Off	128ENAO	167
	*On	128ENA1	167
ISBT Concatenation	*Off	ISBENAO	167
	On	ISBENA1	167
Code 128 Redundancy	Range (0 - 10) *0	128VOT##	167
Code 128 Message Length	Minimum (0 - 80) *0	128MIN##	168
	Maximum (0 - 80) *80	128MAX##	168
Code 128 Append	On	128APP1	168
	*Off	128APPO	168
Code 128 Code Page	Code 128 Code Page (*2)	128DCP##	168

Selection	Setting * Indicates default	Serial Command # Indicates a numeric entry	Page
GS1-128	Default All GS1-128 Settings	GS1DFT	169
	*On	GS1ENA1	169
	Off	GS1ENA0	169
GS1-128 Message Length	Minimum (1 - 80) *1	GS1MIN##	169
	Maximum (0 - 80) *80	GS1MAX##	169
Telepen	Default All Telepen Settings	TELDFT	170
	*Off	TELENA0	170
	On	TELENA1	170
Telepen Output	*AIM Telepen Output	TELOLD0	170
	Original Telepen Output	TELOLD1	170
Telepen Message Length	Minimum (1 - 60) *1	TELMIN##	170
	Maximum (1 - 60) *60	TELMAX##	170
UPC-A	Default All UPC-A Settings	UPADFT	171
	Off	UPBENA0	171
	*On	UPBENA1	171
UPC-A Check Digit	Off	UPACKX0	171
	*On	UPACKX1	171
UPC-A Number System	Off	UPANSX0	172
	*On	UPANSX1	172
UPC-A 2 Digit Addenda	*Off	UPAAD20	172
	On	UPAAD21	172
UPC-A 5 Digit Addenda	*Off	UPAAD50	172
	On	UPAAD51	172
UPC-A Addenda Required	*Not Required	UPAARQ0	172
	Required	UPAARQ1	172
Addenda Timeout	Range (0 - 500) *120	DLYADD#####	173
UPC-A Addenda Separator	Off	UPAADS0	173
	*On	UPAADS1	173
UPC-A/EAN-13 with Extended Coupon Code	*Off	CPNENA0	173
	Allow Concatenation	CPNENA1	173
	Require Concatenation	CPNENA2	173
Addenda Timeout	Range (0 - 500) *120	DLYADD#####	174
Coupon GS1 DataBar Output	*GS1 Output Off	CPNGS10	174
	GS1 Output On	CPNGS11	174

Selection	Setting * Indicates default	Serial Command # Indicates a numeric entry	Page
UPC-E0	Default All UPC-E Settings	UPEDFT	175
	Off	UPEEN00	175
	*On	UPEEN01	175
UPC-E0 Expand	*Off	UPEEXP0	175
	On	UPEEXP1	175
UPC-E0 Addenda Required	Required	UPEARQ1	175
	*Not Required	UPEARQ0	175
Addenda Timeout	Range (0 - 500) *120	DLYADD#####	176
UPC-E0 Addenda Separator	*On	UPEADS1	176
	Off	UPEADS0	176
UPC-E0 Check Digit	Off	UPECKX0	176
	*On	UPECKX1	176
UPC-E0 Leading Zero	Off	UPENSX0	177
	*On	UPENSX1	177
UPC-E0 Addenda	2 Digit Addenda On	UPEAD21	177
	*2 Digit Addenda Off	UPEAD20	177
	5 Digit Addenda On	UPEAD51	177
	*5 Digit Addenda Off	UPEAD50	177
UPC-E1	*Off	UPEEN10	177
	On	UPEEN11	177
EAN/JAN-13	Default All EAN/ JAN Settings	E13DFT	178
	Off	E13ENA0	178
	*On	E13ENA1	178
Convert UPC-A to EAN-13	UPC-A Converted to EAN-13	UPAENA0	178
	*Do not Convert UPC-A	UPAENA1	178
EAN/JAN-13 Check Digit	Off	E13CKX0	179
	*On	E13CKX1	179
EAN/JAN-13 Addenda	2 Digit Addenda On	E13AD21	179
	*2 Digit Addenda Off	E13AD20	179
	5 Digit Addenda On	E13AD51	179
	*5 Digit Addenda Off	E13AD50	179
EAN/JAN-13 Addenda Required	*Not Required	E13ARQ0	179
	Required	E13ARQ1	179
EAN-13 Beginning with 290 Addenda Required	*Don't Require 5 Digit Addenda	ARQ2900	180
	Require 5 Digit Addenda	ARQ2901	180

Selection	Setting * Indicates default	Serial Command # Indicates a numeric entry	Page
EAN-13 Beginning with 378/379 Addenda Required	*Don't Require Addenda	ARQ3780	180
	Require 2 Digit Addenda	ARQ3781	180
	Require 5 Digit Addenda	ARQ3782	180
	Require 2 or 5 Digit Addenda	ARQ3783	180
EAN-13 Beginning with 414/419 Addenda Required	*Don't Require Addenda	ARQ4140	181
	Require 2 Digit Addenda	ARQ4141	181
	Require 5 Digit Addenda	ARQ4142	181
	Require 2 or 5 Digit Addenda	ARQ4143	181
EAN-13 Beginning with 434/439 Addenda Required	*Don't Require Addenda	ARQ4340	182
	Require 2 Digit Addenda	ARQ4341	182
	Require 5 Digit Addenda	ARQ4342	182
	Require 2 or 5 Digit Addenda	ARQ4343	182
EAN-13 Beginning with 977 Addenda Required	*Don't Require 2 Digit Addenda	ARQ9770	182
	Require 2 Digit Addenda	ARQ9771	182
EAN-13 Beginning with 978 Addenda Required	*Don't Require 5 Digit Addenda	ARQ9780	183
	Require 5 Digit Addenda	ARQ9781	183
EAN-13 Beginning with 979 Addenda Required	*Don't Require 5 Digit Addenda	ARQ9790	183
	Require 5 Digit Addenda	ARQ9791	183
Addenda Timeout	Range (0 - 500) *120	DLYADD#####	184
EAN/JAN-13 Addenda Separator	Off	E13ADS0	184
	*On	E13ADS1	184
ISBN Translate	*Off	E13ISB0	185
	On	E13ISB1	185
EAN/JAN-8	Default All EAN/ JAN-8 Settings	EA8DFT	185
	Off	EA8ENAO	185
	*On	EA8ENA1	185
EAN/JAN-8 Check Digit	Off	EA8CKX0	185
	*On	EA8CKX1	185
EAN/JAN-8 Addenda	*2 Digit Addenda Off	EA8AD20	186
	2 Digit Addenda On	EA8AD21	186
	*5 Digit Addenda Off	EA8AD50	186
	5 Digit Addenda On	EA8AD51	186
EAN/JAN-8 Addenda Required	*Not Required	EA8ARQ0	186
	Required	EA8ARQ1	186
Addenda Timeout	Range (0 - 500) *120	DLYADD#####	186
EAN/JAN-8 Addenda Separator	Off	EA8ADS0	187
	*On	EA8ADS1	187

Selection	Setting * Indicates default	Serial Command # Indicates a numeric entry	Page
MSI	Default All MSI Settings	MSIDFT	187
	*Off	MSIENAO	187
	On	MSIENA1	187
MSI Check Character	*Validate Type 10, but Don't Transmit	MSICHK0	188
	Validate Type 10 and Transmit	MSICHK1	188
	Validate 2 Type 10 Chars, but Don't Transmit	MSICHK2	188
	Validate 2 Type 10 Chars and Transmit	MSICHK3	188
	Validate Type 11 then Type 10 Char, but Don't Transmit	MSICHK4	188
	Validate Type 11 then Type 10 Char and Transmit	MSICHK5	188
	Disable MSI Check Characters	MSICHK6	188
MSI Message Length	Minimum (4 - 48) *4	MSIMIN##	189
	Maximum (4 - 48) *48	MSIMAX##	189
GS1 DataBar Omnidirectional	Default All GS1 DataBar Omnidirectional Settings	RSSDFT	189
	Off	RSSENA0	189
	*On	RSSENA1	189
GS1 DataBar Limited	Default All GS1 DataBar Limited Settings	RSLDFT	190
	Off	RSLENA0	190
	*On	RSLENA1	190
GS1 DataBar Expanded	Default All GS1 DataBar Expanded Settings	RSEDFT	190
	Off	RSEENA0	190
	*On	RSEENA1	190
GS1 DataBar Expanded Msg. Length	Minimum (4 - 74) *4	RSEMIN##	190
	Maximum (4 - 74) *74	RSEMAX##	190
Trioptic Code	*Off	TRIENA0	191
	On	TRIENA1	191
Codablock A	Default All Codablock A Settings	CBADFT	191
	*Off	CBAENA0	191
	On	CBAENA1	191
Codablock A Msg. Length	Minimum (1 - 600) *1	CBAMIN###	192
	Maximum (1 - 600) *600	CBAMAX###	192

Selection	Setting * Indicates default	Serial Command # Indicates a numeric entry	Page
Codablock F	Default All Codablock F Settings	CBFDFT	192
	*Off	CBFENA0	192
	On	CBFENA1	192
Codablock F Msg. Length	Minimum (1 - 2048) *1	CBFMIN####	192
	Maximum (1 - 2048) *2048	CBFMAX####	192
Label Code	On	LBLENA1	193
	*Off	LBLENA0	193
PDF417	Default All PDF417 Settings	PDFDFT	193
	*On	PDFENA1	193
	Off	PDFENA0	193
PDF417 Msg. Length	Minimum (1-2750) *1	PDFMIN####	194
	Maximum (1-2750) *2750	PDFMAX####	194
MacroPDF417	*On	PDFMAC1	194
	Off	PDFMAC0	194
MicroPDF417	Default All Micro PDF417 Settings	MPDDFT	194
	On	MPDENA1	194
	*Off	MPDENA0	194
MicroPDF417 Msg. Length	Minimum (1-366) *1	MPDMIN###	195
	Maximum (1-366) *366	MPDMAX###	195
GS1 Composite Codes	On	COMENA1	195
	*Off	COMENA0	195
UPC/EAN Version	On	COMUPC1	196
	*Off	COMUPC0	196
GS1 Composite Codes Msg. Length	Minimum (1-2435) *1	COMMINS###	196
	Maximum (1-2435) *2435	COMMINS###	196
GS1 Emulation	GS1-128 Emulation	EANEMU1	196
	GS1 DataBar Emulation	EANEMU2	195
	GS1 Code Expansion Off	EANEMU3	197
	EAN8 to EAN13 Conversion	EANEMU4	197
	*GS1 Emulation Off	EANEMU0	197
TCIF Linked Code 39	On	T39ENA1	197
	*Off	T39ENA0	197
QR Code	Default All QR Code Settings	QRCDFT	198
	*On	QRCENA1	198
	Off	QRCENA0	198
QR Code Msg. Length	Minimum (1-7089) *1	QRCSMIN####	198
	Maximum (1-7089) *7089	QRCSMAX####	198

Selection	Setting * Indicates default	Serial Command # Indicates a numeric entry	Page
QR Code Append	*One Scan	QRCAPP1	198
	Swipe	QRCAPP2	198
	Point & Shoot	QRCAPP3	198
	Off	QRCAPP0	198
QR Code Page	QR Code Page (*3)	QRCDCP##	199
DotCode	Default All DotCode Settings	DOTDFT	200
	On	DOTENA1	200
	*Off	DOTENA0	200
Poor Quality DotCodes	Poor Quality DotCodes On	DOTEXS1	200
	*Poor Quality DotCodes Off	DOTEXS0	200
DotCode Msg. Length	Minimum (1- 2400) *1	DOTMIN####	200
	Maximum (1- 2400) *2400	DOTMAX####	200
Digimarc Barcode	Decoder Attempts (0-10) *3	DIGSTR##	201
	Off	DIGENA0	201
	On	DIGENA1	201
	Uses ID Decoder then Both Decoders	DIGENA2	201
	*Uses Digimarc Decoder then Both Decoders	DIGENA3	201
	Uses ID Decoder then Alternates Decoders	DIGENA4	201
	Uses Digimarc Decoder then Alternates Decoders	DIGENA5	201
Data Matrix	Default All Data Matrix Settings	IDMDFT	201
	*On	IDMENA1	201
	Off	IDMENA0	201
Direct Part Marking (DPM) Decoding	Dotpeen DPM Decoding	DPMENA1	202
	*Disable DPM Decoding	DPMENA0	202
	Reflective (Etched) DPM Decoding	DPMENA2	202
Data Matrix Msg. Length	Minimum (1-3116) *1	IDMMIN####	203
	Maximum (1-3116) *3116	IDMMAX####	203
Data Matrix Code Page	Data Matrix Code Page (*51)	IDMDCP##	203
MaxiCode	Default All MaxiCode Settings	MAXDFT	204
	On	MAXENA1	204
	*Off	MAXENA0	204
MaxiCode Msg. Length	Minimum (1-150) *1	MAXMIN###	204
	Maximum (1-150) *150	MAXMAX###	204

Selection	Setting * Indicates default	Serial Command # Indicates a numeric entry	Page
Aztec Code	Default All Aztec Code Settings	AZTDFT	205
	*On	AZTENA1	205
	Off	AZTENA0	205
Aztec Code Msg. Length	Minimum (1-3832) *1	AZTMIN####	205
	Maximum (1-3832) *3832	AZTMAX####	205
Aztec Append	*On	AZTAPP1	205
	Off	AZTAPP0	205
Aztec Code Page	Aztec Code Page (*51)	AZTDCP##	206
Chinese Sensible (Han Xin) Code	Default All Han Xin Code Settings	HX_DFT	206
	On	HX_ENA1	206
	*Off	HX_ENA0	206
Chinese Sensible (Han Xin) Code Msg. Length	Minimum (1-7833) *1	HX_MIN####	207
	Maximum (1-7833) *7833	HX_MAX####	207
Postal Codes - 2D			
2D Postal Codes	*Off	POSTAL0	207
Single 2D Postal Codes	Australian Post On	POSTAL1	207
	British Post On	POSTAL7	207
	Canadian Post On	POSTAL30	207
	Intelligent Mail Barcode On	POSTAL10	207
	Japanese Post On	POSTAL3	208
	KIX Post On	POSTAL4	208
	Planet Code On	POSTAL5	208
	Postal-4i On	POSTAL9	208
	Postnet On	POSTAL6	208
	Postnet with B and B' Fields On	POSTAL11	208
	InfoMail On	POSTAL2	208
Combination 2D Postal Codes	InfoMail and British Post On	POSTAL8	208
	Intelligent Mail Barcode and Postnet with B and B' Fields On	POSTAL20	208
	Postnet and Postal-4i On	POSTAL14	209
	Postnet and Intelligent Mail Barcode On	POSTAL16	209
	Postal-4i and Intelligent Mail Barcode On	POSTAL17	209
	Postal-4i and Postnet with B and B' Fields On	POSTAL19	209
	Planet and Postnet On	POSTAL12	209
Planet and Postnet with B and B' Fields On	POSTAL18	209	

Selection	Setting * Indicates default	Serial Command # Indicates a numeric entry	Page
	Planet and Postal-4i On	POSTAL13	209
	Planet and Intelligent Mail Barcode On	POSTAL15	209
	Planet, Postnet, and Postal-4i On	POSTAL21	209
	Planet, Postnet, and Intelligent Mail Barcode On	POSTAL22	209
	Planet, Postal-4i, and Intelligent Mail Barcode On	POSTAL23	210
	Postnet, Postal-4i, and Intelligent Mail Barcode On	POSTAL24	210
	Planet, Postal-4i, and Postnet with B and B' Fields On	POSTAL25	210
	Planet, Intelligent Mail Barcode, and Postnet with B and B' Fields On	POSTAL26	210
	Postal-4i, Intelligent Mail Barcode, and Postnet with B and B' Fields On	POSTAL27	210
	Planet, Postal-4i, Intelligent Mail Barcode, and Postnet On	POSTAL28	210
	Planet, Postal-4i, Intelligent Mail Barcode, and Postnet with B and B' Fields On	POSTAL29	210
Planet Code Check Digit	Transmit	PLNCKX1	210
	*Don't Transmit	PLNCKX0	211
Postnet Check Digit	Transmit	NETCKX1	211
	*Don't Transmit	NETCKX0	211
Australian Post Interpretation	*Bar Output	AUSINT0	211
	Numeric N Table	AUSINT1	211
	Alphanumeric C Table	AUSINT2	211
	Combination N and C Tables	AUSINT3	212
Postal Codes - Linear			
China Post (Hong Kong 2 of 5)	Default All China Post (Hong Kong 2 of 5) Settings	CPCDFT	212
	*Off	CPCENA0	212
	On	CPCENA1	212
China Post (Hong Kong 2 of 5) Msg. Length	Minimum (2 - 80) *4	CPCMIN##	212
	Maximum (2 - 80) *80	CPCMAX##	212
Korea Post	Default All Korea Post Settings	KPCDFT	213
	*Off	KPCENA0	213
	On	KPCENA1	213

Selection	Setting * Indicates default	Serial Command # Indicates a numeric entry	Page
Korea Post Msg. Length	Minimum (2 - 80) *4	KPCMIN##	213
	Maximum (2 - 80) *48	KPCMAX##	213
Korea Post Check Digit	Transmit Check Digit	KPCCHK1	213
	*Don't Transmit Check Digit	KPCCHK0	213
Imaging Default Commands			
Image Snap	Default all Imaging Commands	IMGDFT	215
	Imaging Style - Decoding	SNPSTY0	216
	*Imaging Style - Photo	SNPSTY1	216
	Imaging Style - Manual	SNPSTY2	216
	Beeper On	SNPBEP1	216
	*Beeper Off	SNPBEP0	216
	*Wait for Trigger Off	SNPTRG0	217
	Wait for Trigger On	SNPTRG1	217
	*LED State - Off	SNPLED0	217
	LED State - On	SNPLED1	217
	Exposure (1-7874 microseconds) *7874	SNPEXP	217
	*Gain - None	SNPGAN1	218
	Gain - Medium	SNPGAN2	218
	Gain - Heavy	SNPGAN4	218
	Gain - Maximum	SNPGAN8	218
	Target White Value (0-255) *125	SNPWHT###	218
	Delta for Acceptance (0-255) *25	SNPDEL###	218
	Update Tries (0-10) *6	SNPTRY##	219
	Target Set Point Percentage (1-99) *50	SNPPCT##	219
	Image Ship	*Infinity Filter - Off	IMGINFO
Infinity Filter - On		IMGINF1	220
*Compensation Off		IMGCOR0	220
Compensation On		IMGCOR1	220
*Pixel Depth - 8 bits/pixel (grayscale)		IMGBPP8	220
Pixel Depth - 1 bit/pixel (B&W)		IMGBPP1	220
*Don't Sharpen Edges		IMGEDG0	221
Sharpen Edges (0-23)		IMGEDG##	221
*File Format - JPEG		IMGFMT6	221
File Format - KIM		IMGFMT0	221
File Format - TIFF binary		IMGFMT1	221

Selection	Setting * Indicates default	Serial Command # Indicates a numeric entry	Page
	File Format - TIFF binary group 4, compressed	IMGFMT2	221
	File Format - TIFF grayscale	IMGFMT3	221
	File Format - Uncompressed binary	IMGFMT4	221
	File Format - Uncompressed grayscale	IMGFMT5	221
	File Format - BMP	IMGFMT8	221
	*Histogram Stretch Off	IMGHIS0	222
	Histogram Stretch On	IMGHIS1	222
	*Noise Reduction Off	IMGFSP0	223
	Noise Reduction On	IMGFSP1	223
	Invert Image around X axis	IMGNVX1	222
	Invert Image around Y axis	IMGNVY1	222
	Rotate Image none	IMGROTO	223
	Rotate Image 90° right	IMGROT1	223
	Rotate Image 180° right	IMGROT2	223
	Rotate Image 90° left	IMGROT3	223
	JPEG Image Quality (0-100) *50	IMGJQF###	224
	*Gamma Correction Off	IMGGAM0	224
	Gamma Correction On (0-1000)	IMGGAM###	224
	Image Crop - Left (0-843) *0	IMGWNL###	224
	Image Crop - Right (0-843) *843	IMGWNR###	224
	Image Crop - Top (0-639) *0	IMGWNT###	224
	Image Crop - Bottom (0-639) *639	IMGWNB###	225
	Image Crop - Margin (1-238) *0	IMGMAR###	225
	Protocol - None (raw)	IMGXFR0	225
	Protocol - None (default USB)	IMGXFR2	225
	Protocol - Hmodem Compressed (default RS232)	IMGXFR3	225
	Protocol - Hmodem	IMGXFR4	225
	*Ship Every Pixel	IMGSUB1	226
	Ship Every 2nd Pixel	IMGSUB2	226
	Ship Every 3rd Pixel	IMGSUB3	226
	*Document Image Filter Off	IMGUSH0	226
	Document Image Filter On (0-255)	IMGUSH###	226
	*Don't Ship Histogram	IMGHST0	227

Selection	Setting * Indicates default	Serial Command # Indicates a numeric entry	Page
	Ship Histogram	IMGHST1	227
Image Size Compatibility	Force VGA Resolution	IMGVGA1	227
	*Native Resolution	IMGVGA0	228
Intelligent Signature Capture	Optimize On	DECBND1	228
	*Optimize Off	DECBND0	228
Utilities			
Add Code I.D. Prefix to All Symbologies (Temporary)		PRECA2,BK2995C80!	235
Show Software Revision		REVINF	235
Test Menu	On	TSTMNU1	236
	*Off	TSTMNU0	236
Application Plug-Ins (Apps)	*Decoding Apps On	PLGDCE1	236
	Decoding Apps Off	PLGDCE0	236
	*Formatting Apps On	PLGFOE1	236
	Formatting Apps Off	PLGFOE0	236
	List Apps	PLGINF	236
Reset the Factory Defaults	Remove Custom Defaults	DEFOVR	238
	Activate Defaults	DEFALT	238

Xenon XP 1950g/1950h Corded Scanner Product Specifications

Parameter	Specification
Mechanical	
Height	6.3 inches (160mm)
Length	4.1 inches (104mm)
Width	2.8 inches (71mm)
Weight	
General Duty	5.3 ounces (150g)
Healthcare	5.5 ounces (155g)
Electrical	
Voltage Requirements	4.4 to 5.5 VDC at input connector
Current Draw	Scanning Standby 500mA @ 5VDC, 2.5W
Illumination LED: Peak Wavelength	624nm \pm 18nm (red LED) IEC 62471: "Exempt Risk Group" 442nm, 552nm (white LED) IEC 62471: "Exempt Risk Group"
Aiming: Peak Wavelength LED	624nm \pm 18nm (red LED) 520nm \pm 18nm (green LED) IEC 62471: "Exempt Risk Group"
Environmental	
Temperature Ranges:	
Operating	32°F to 122°F (0°C to 50°C)
Storage	-40°F to 158°F (-40°C to 70°C)
Humidity	0 to 95% non-condensing

Parameter (Continued)	Specification
Mechanical Drop	Operational after 50 drops from 6 feet (1.8m) to concrete
ESD Tolerance	Up to 15kV direct air Up to 8 kV indirect coupling plane
Sealant Rating	IP52
Image	
Image Size	1280 x 800 pixels
Scan Performance	
Skew Angle	±65°
Pitch Angle 1D barcode 2D barcode	1D code: ±65° 2D code: ±45°
Motion Tolerance	Up to 4.0 m/s (157 in/s) for 13 mil UPC at optimal focus
Symbol Contrast	20% or greater (Grade A)
Scan Angle (Minimum) Standard Range High Density Ultra High Density	SR: Horizontal: 42°; Vertical: 27° HD: Horizontal: 42°; Vertical 27° UD: Horizontal: 40°; Vertical 26°

Xenon XP 1952g/1952h Cordless Scanner Product Specifications

Parameter	Specification
Mechanical	
Height	6.3 inches (160mm)
Length	4.1 inches (104mm)
Width	2.8 inches (71mm)
Weight General Duty Healthcare	7.8 ounces (220g) 8.0 ounces (227g)
Electrical	
Current Draw	Operating Power (Charging) 500mA @ 5VDC, 2.5W
Illumination LED: Peak Wavelength	624nm ± 18nm (red LED) IEC 62471: "Exempt Risk Group" 442nm, 552nm (white LED) IEC 62471: "Exempt Risk Group"
Aiming:	

Parameter (Continued)	Specification
Peak Wavelength LED	624nm ± 18nm (red LED) 520nm ± 18nm (green LED) IEC 62471: "Exempt Risk Group"
Battery	
Lithium Ion	2400 mAHr minimum
Number of Scans	Up to 50,000 per charge
Expected Hours of Operation	14
Expected Charge Time	4.5 hours
Radio	
Frequency	2.4 to 2.5 GHz (ISM Band) Frequency Hopping Bluetooth v 4.2
Range	33 ft. (10 m) typical
Environmental	
Temperature Ranges:	
Operating	32° F to +122° F (0° C to 50° C)
Storage with battery*	-4°F to +95°F (-20°C to 35°C) for storage up to 90 days -4°F to +68°F (-20°C to 20°C) for storage up to 365 days
Storage without battery	-40°F to +158°F (-40°C to 70°C)
Humidity	Up to 95% non-condensing
Mechanical Drop	Operational after 50 drops from 6 feet (1.8 m) to concrete
ESD Sensitivity	Up to 15kV direct air Up to 8 kV indirect coupling plane
Sealant Rating	IP52
Image	
Image Size	1280 x 800 pixels
Scan Performance	
Skew Angle	±65°
Pitch Angle	
1D barcode	1D barcodes: ±65°
2D barcode	2D barcodes: ±45°
Motion Tolerance	Up to 4.0 m/s (157 in/s) for 13 mil UPC at optimal focus
Symbol Contrast	20% or greater (Grade A)
Scan Angle	
Standard Range	SR: Horizontal: 48°; Vertical: 30°
High Density	HD: Horizontal: 48°; Vertical: 30°
Ultra High Density	UD: Horizontal: 46°; Vertical: 29°

*Storage outside of this temperature range could be detrimental to battery life.

Xenon XP 1952g-BF/1952h-BF Scanner Product Specifications

Parameter	Specification
Mechanical	
Height	6.3 inches (160mm)
Length	4.1 inches (104mm)
Width	2.8 inches (71mm)
Weight	
General Duty	6.9 ounces (195g)
Healthcare	7.1 ounces (201g)
Use Time	
# of Scans per full charge	450 scans @ 1 scan per second
Expected Minutes of Operation	25 minutes @ 5 scans per minute
Electrical	
Current Draw	Operating Power (Charging) 500mA @ 5VDC, 2.5W
Illumination LED: Peak Wavelength	624nm \pm 18nm (red LED) IEC 62471: "Exempt Risk Group" 442nm, 552nm (white LED) IEC 62471: "Exempt Risk Group"
Aiming: Peak Wavelength LED	624nm \pm 18nm (red LED) 520nm \pm 18nm (green LED) IEC 62471: "Exempt Risk Group"
Radio	
Frequency	2.4 to 2.5 GHz (ISM Band) Frequency Hopping Bluetooth v.4.2
Range	33 ft. (10 m) typical
Environmental	
Temperature Ranges:	
Operating	32° F to +122° F (0° C to 50° C)
Storage	-40°F to +158°F (-40°C to 70°C)
Humidity	Up to 95% non-condensing
Mechanical Drop	Operational after 50 drops from 3.3 feet (1 m) to concrete
ESD Sensitivity	Up to 15kV direct air Up to 8 kV indirect coupling plane
Sealant Rating	IP52
Image	
Image Size	1280 x 800 pixels

Parameter (Continued)	Specification
Scan Performance	
Skew Angle	±65°
Pitch Angle 1D barcode 2D barcode	1D barcodes: ±65° 2D barcodes: ±45°
Motion Tolerance	Up to 4.0 m/s (157 in/s) for 13 mil UPC at optimal focus
Symbol Contrast	20% or greater (Grade A)
Scan Angle Standard Range High Density Ultra High Density	SR: Horizontal: 48°; Vertical: 30° HD: Horizontal: 48°; Vertical: 30° UD: Horizontal: 46°; Vertical: 29°

CCB01-010BT/CCB01-010BT-BF Charge Base Product Specifications

Parameter	Specification
Mechanical	
Height	3.2 inches (81.3mm)
Length	5.19 inches (131.8mm)
Width	3.98 inches (101.1mm)
Weight	6.3 oz (179g)
Electrical	
Voltage:	4.5 to 5.5 VDC
Current Draw:	
Host Terminal Port	500mA
Aux Power Port	1A
Charge Time	5 hours
Radio	
Frequency	2.4 to 2.5 GHz (ISM Band) Frequency Hopping Bluetooth v.2.1
Range	33 ft. (10 m) typical
Data Rate	Up to 1 MBps
Environmental	
Temperature Ranges:	
Operating	32° F to +122° F (0° C to +50° C)
Storage	-40° F to +158° F (-40° C to +70° C)
Humidity	Up to 95% non-condensing
Mechanical Drop	Operational after 50 drops from 3.28 feet (1 m) to concrete

Parameter (Continued)	Specification
Vibration	5G Peak from 22Hz to 300Hz
ESD Sensitivity	Up to 15kV direct air Up to 8 kV indirect coupling plane
Sealant Rating	IP41

CCB-H-010BT/CCB-H-010BT-BF Charge Base Product Specifications

Parameter	Specification
Mechanical	
Height	3.3 inches (83mm)
Length	9.1 inches (231mm)
Width	3.5 inches (89mm)
Weight	9.2 oz (260g)
Electrical	
Voltage:	4 to 5.5 VDC
Current Draw:	
Host Terminal Port	500mA
Aux Power Port	1A
Charge Time (CCB-H-010BT)	From shut down to fully charged: 120 seconds via standard USB only 30 seconds via powered USB with external power
Charge Time (CCB-H-010BT-BF)	From shut down to fully charged: 25 seconds via standard USB only 15 seconds via powered USB with external power
Radio	
Frequency	2.4 to 2.5 GHz (ISM Band) Frequency Hopping Bluetooth v.4.2
Range	33 ft. (10 m) typical
Data Rate	Up to 130 kbps
Environmental	
Temperature Ranges:	
Operating/Battery Charge	41° F to +104° F (5° C to +40° C)
Storage without battery	-40° F to +158° F (-40° C to +70° C)
Humidity	Up to 95% non-condensing
Mechanical Drop	Operational after 50 drops from 3.3 feet (1m) to concrete
Vibration	5G Peak from 22Hz to 300Hz
ESD Sensitivity	Up to 15kV direct air Up to 8 kV indirect coupling plane

Parameter (Continued)	Specification
Sealant Rating	IP42

Depth of Field Charts

1950g/1952g/1952g-BF Typical Performance

Focus		Standard Range		High Density		Ultra High Density	
Symbology		Near Distance	Far Distance	Near Distance	Far Distance	Near Distance	Far Distance
2 mil Code 39	mm	n/a	n/a	n/a	n/a	20	60
	in.	n/a	n/a	n/a	n/a	0.8	2.4
3 mil Code 39	mm	56	132	27	131	5	90
	in.	2.2	5.2	1.1	5.2	0.2	3.5
5 mil Code 39	mm	28	242	14	219	5	115
	in.	1.1	9.5	0.6	8.6	0.2	4.5
10 mil Code 39	mm	0	443	0	389	0	205
	in.	0	17.4	0	15.3	0	8.1
13 mil UPC	mm	0	490	0	368	0	190
	in.	0	19.3	0	14.5	0	7.5
7.5 mil Code 128	mm	25	295	5	260	0	120
	in.	1.0	11.6	0.2	10.2	0	4.7
15 mil Code 128	mm	0	543	0	417	0	200
	in.	0	21.4	0	16.4	0	7.9
20 mil Code 39	mm	4	822	6	604	5	340
	in.	0.2	32.4	0.2	23.8	0.2	13.4
5 mil PDF417	mm	54	160	30	155	5	85
	in.	2.1	6.3	1.2	6.1	0.2	3.3
6.7 mil PDF417	mm	34	220	17	211	0	100
	in.	1.4	8.7	0.7	8.3	0	3.9
5 mil Data Matrix	mm	n/a	n/a	45	100	15	70
	in.	n/a	n/a	1.8	3.9	0.6	2.8
7.5 mil Data Matrix	mm	49	172	27	160	10	90
	in.	1.9	6.8	1.0	6.3	0.4	3.5
10 mil Data Matrix	mm	29	245	12	211	5	105
	in.	1.1	9.7	0.5	8.3	0.2	4.1
4 mil QR Code	mm	n/a	n/a	n/a	n/a	25	55
	in.	n/a	n/a	n/a	n/a	1.0	2.2

Focus (Continued)		Standard Range		High Density		Ultra High Density	
Symbology (Continued)		Near Distance	Far Distance	Near Distance	Far Distance	Near Distance	Far Distance
10 mil QR Code	mm	35	250	10	185	0	105
	in.	1.4	9.8	0.4	7.3	0	4.1
20 mil QR Code	mm	0	438	0	331	0	160
	in.	0	17.2	0	13.0	0	6.3
Resolution (1D)		3 mil (.076mm)		2.5 mil (.064mm)		2.0 mil (
Resolution (PDF-417)		4 mil (.102mm)		3 mil (.076mm)		3 mil (.076mm)	
Resolution (QR/DM)		6 mil (.152mm)		5 mil (.127mm)		4 mil (.102mm)	

1950g/1952g/1952g-BF Guaranteed Performance

Focus		Standard Range		High Density		Ultra High Density	
Symbology		Near Distance	Far Distance	Near Distance	Far Distance	Near Distance	Far Distance
2 mil Code 39	mm	n/a	n/a	n/a	n/a	20	55
	in.	n/a	n/a	n/a	n/a	0.8	2.2
3 mil Code 39	mm	74	113	40	117	5	85
	in.	2.9	4.4	1.6	4.6	0.2	3.3
5 mil Code 39	mm	37	219	21	206	5	100
	in.	1.5	8.6	0.8	8.1	0.2	3.9
10 mil Code 39	mm	10	336	10	340	0	185
	in.	0.4	13.2	0.4	13.4	0	7.3
13 mil UPC	mm	10	419	10	328	0	175
	in.	0.4	16.5	0.4	12.9	0	6.9
7.5 mil Code 128	mm	25	290	5	235	0	105
	in.	1.0	11.4	0.2	9.3	0	4.1
15 mil Code 128	mm	10	447	10	365	0	180
	in.	0.4	17.6	0.4	14.4	0	7.1
20 mil Code 39	mm	13	609	14	526	10	305
	in.	0.5	24.0	0.6	20.7	0.4	12.0
5 mil PDF417	mm	68	149	36	147	5	85
	in.	2.7	5.9	1.4	5.8	0.2	3.3
6.7 mil PDF417	mm	46	205	20	200	0	95
	in.	1.8	8.1	0.8	7.9	0	3.7
5 mil Data Matrix	mm	n/a	n/a	50	90	20	60
	in.	n/a	n/a	2.0	3.5	0.8	2.4
7.5 mil Data Matrix	mm	66	153	32	145	10	80
	in.	2.6	6.0	1.3	5.7	0.4	3.1

Focus (Continued)		Standard Range		High Density		Ultra High Density	
Symbology (Continued)		Near Distance	Far Distance	Near Distance	Far Distance	Near Distance	Far Distance
10 mil Data Matrix	mm	44	227	18	195	10	95
	in.	1.7	8.9	0.7	7.7	0.4	3.7
4 mil QR Code	mm	n/a	n/a	n/a	n/a	25	45
	in.	n/a	n/a	n/a	n/a	1.0	1.8
10 mil QR Code	mm	25	240	15	155	10	90
	in.	1.0	9.4	0.6	6.1	0.4	3.5
20 mil QR Code	mm	21	351	23	290	20	145
	in.	0.8	13.8	0.9	11.4	0.8	5.7

1950h/1952h/1952h-BF Typical Performance

Focus		Standard Range		High Density	
Symbology		Near Distance	Far Distance	Near Distance	Far Distance
5 mil Code 39	mm	28	253	16	219
	in.	1.1	10	0.6	8.6
13 mil UPC	mm	0	495	0	366
	in.	0	19.5	0	14.4
20 mil Code 39	mm	3	829	4	620
	in.	0.1	32.6	0.2	24.4
6.7 mil PDF417	mm	34	221	16	212
	in.	1.3	8.7	0.6	8.3
10 mil Data Matrix	mm	27	249	11	214
	in.	1.1	9.8	0.4	8.4
20 mil QR Code	mm	0	453	0	328
	in.	0	17.8	0	12.9
Resolution (1D)		3 mil (.076mm)		2.5 mil (.064mm)	
Resolution (PDF-47)		4 mil (.102mm)		3 mil (.076mm)	
Resolution (QR/DM)		6 mil (.152mm)		5 mil/4 mil (0.127mm)/ (.102mm)	

1950h/1952h/1952h-BF Guaranteed Performance

Focus		Standard Range		High Density	
Symbology		Near Distance	Far Distance	Near Distance	Far Distance
5 mil Code 39	mm	38	233	22	201
	in.	1.5	9.2	0.9	7.9
13 mil UPC	mm	10	416	10	322
	in.	0.4	16.4	0.4	12.7
20 mil Code 39	mm	13	602	14	560
	in.	0.5	23.7	0.6	20.7
6.7 mil PDF417	mm	49	208	24	200
	in.	1.9	8.2	0.9	7.9
10 mil Data Matrix	mm	46	233	18	194
	in.	1.8	9.2	0.7	7.6
20 mil QR Code	mm	15	373	13	259
	in.	0.6	14.7	0.5	10.2

Standard Connector Pinouts

Note: The following pin assignments are not compatible with some Honeywell legacy products. Use of a cable with improper pin assignments may lead to damage to the unit. Use of any cables not provided by the manufacturer may result in damage not covered by your warranty.

Keyboard Wedge

10 Pin RJ41 Modular Plug - connects to the base

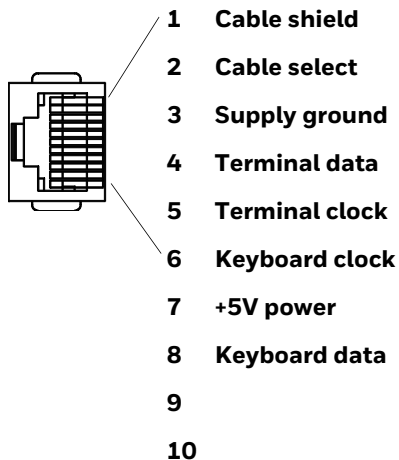

Serial Output

10 Pin RJ41 Modular Plug - connects to the base

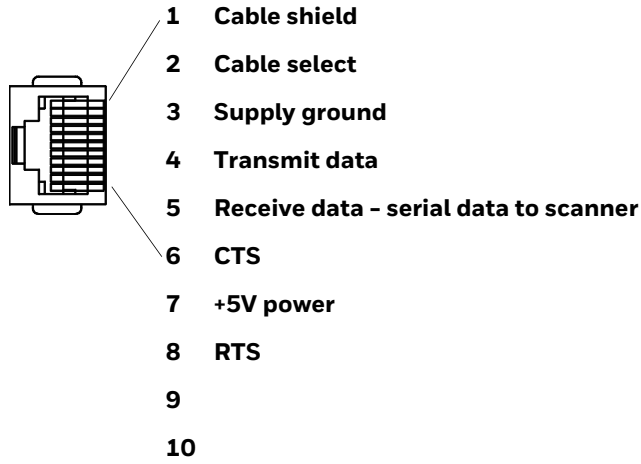

RS485 Output

10 Pin RJ41 Modular Plug - connects to the base

Note: RS485 signal conversion is performed in the cable.

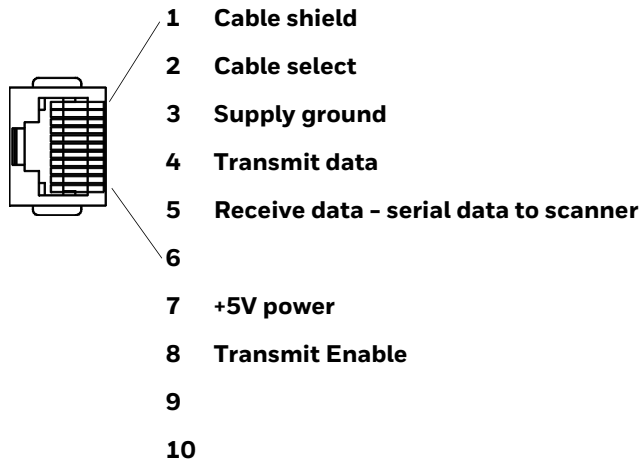

USB

10 Pin Modular Plug - connects to the base

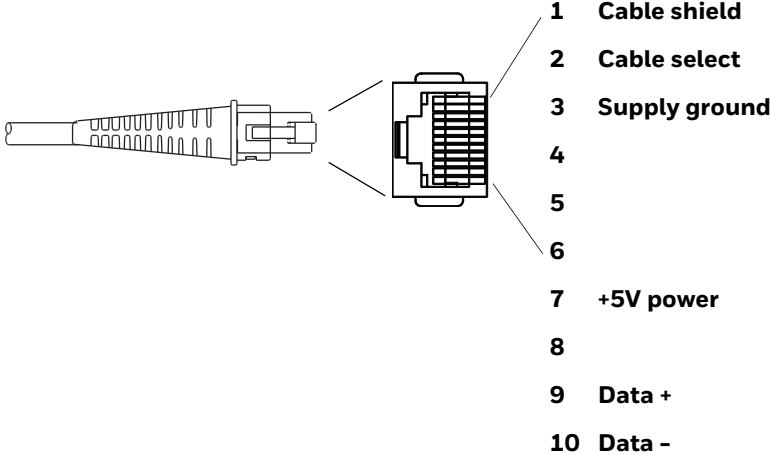

Required Safety Labels

Scanner

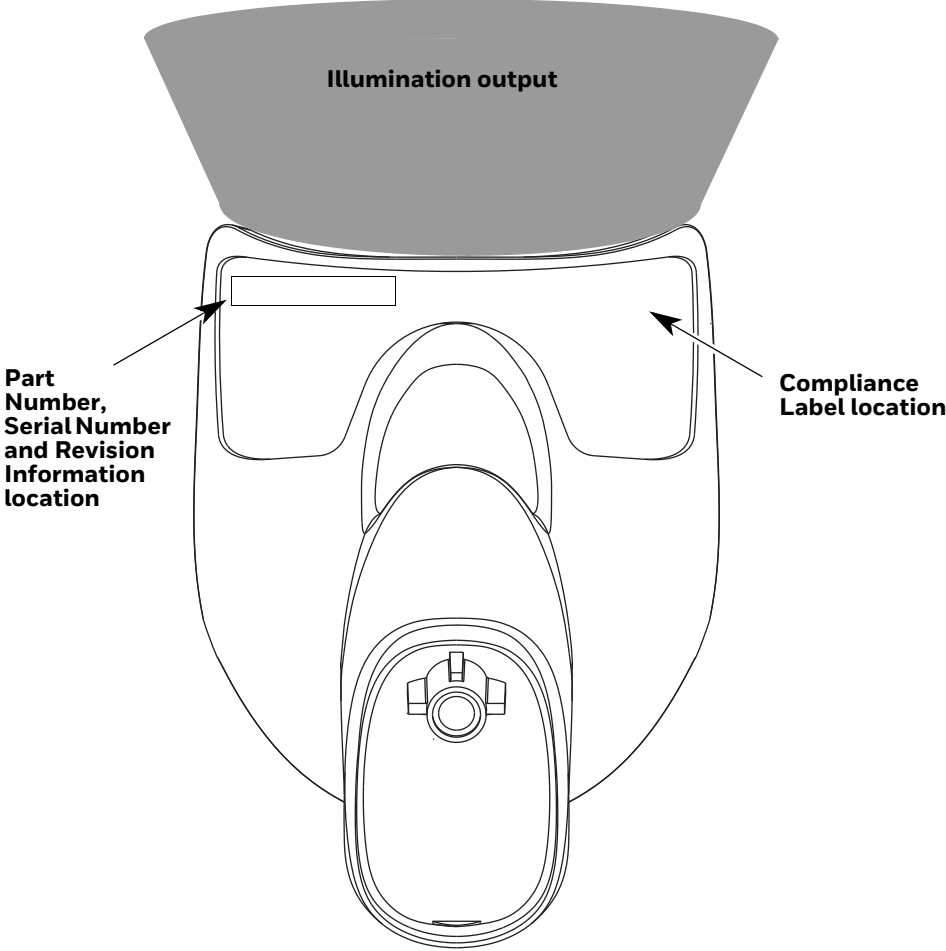

CCB01-010BT/CCB01-010BT-BF Base

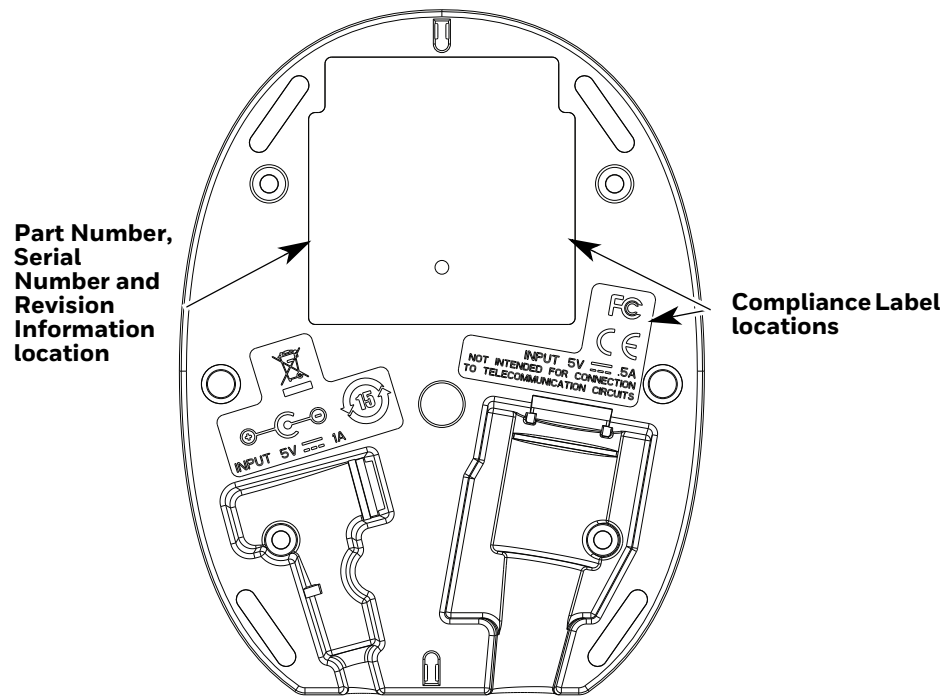

CCB-H-010BT/CCB-H-010BT-BF Base

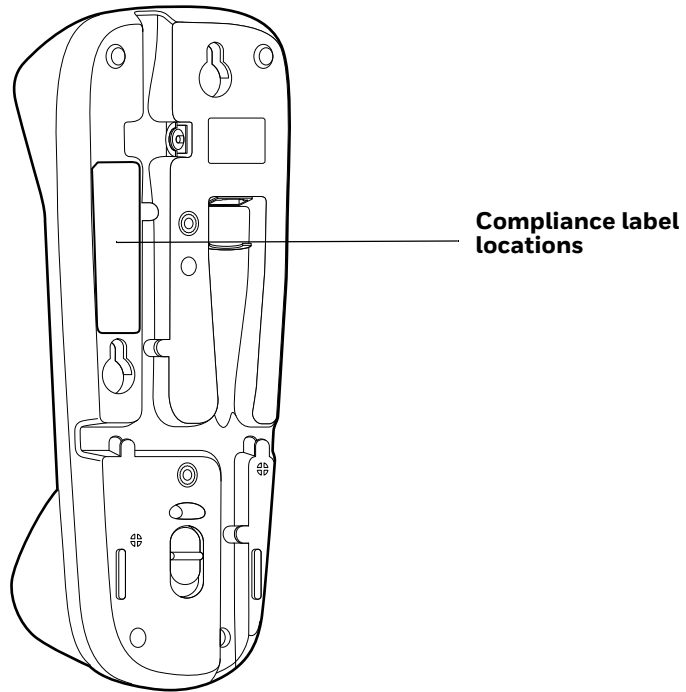

MAINTENANCE AND TROUBLESHOOTING

Repairs

Repairs and/or upgrades are not to be performed on this product. These services are to be performed only by an authorized service center (see [Customer Support](#) on page xvii).

Maintenance

Your device provides reliable and efficient operation with a minimum of care. Although specific maintenance is not required, the following sections describe periodic checks to ensure dependable operation.

Clean the Scanner

The scanner or base's housing and scanner window may be cleaned with a soft cloth dampened with water or a mild detergent-water solution. If a mild detergent solution is used, wipe the scanner or base with a clean cloth dampened only with water to remove any detergent residue.

Note: *Reading performance may degrade if the scanner's window is not clean. If the window is visibly dirty, or if the scanner isn't operating well, clean the window.*



Caution: **Do not submerge the scanner in water or cleaning solution. Do not use abrasive wipes or cloths on the scanner's window. Abrasive wipes may scratch the window. Never use solvents (e.g., acetone) on the housing or window. Solvents may damage the finish or the window.**

Caution: **Ensure all components are dry prior to mating the scanner with charging accessories or other peripheral devices. Mating wet components may cause damage not covered by the warranty.**

About Disinfectant-ready Models

Some configurations of Xenon XP scanners are available with an external plastic housing that is designed to resist the effects of harsh chemicals. These scanners are equipped with disinfectant-ready housings (DRH) for the healthcare and general-purpose markets.

Please refer to the Honeywell Safety and Productivity Solutions website for specific details on how to clean Xenon XP scanners with disinfectant-ready housings. Helpful information on the care of these specialty products can be found in the following articles:

- [Learn to Clean Honeywell Healthcare Disinfectant-ready Products](#)
- [Honeywell Instructions for Cleaning General Purpose Disinfectant-ready Housing Devices](#)
- [Disinfectant-Ready Application Brief](#)

Inspect Cords and Connectors

Inspect the interface cable and connector for wear or other signs of damage. A badly worn cable or damaged connector may interfere with scanner operation. Contact your distributor for information about cable replacement. Cable replacement instructions are on [page 292](#).

Replace Cables in Corded Scanners

The standard interface cable is attached to the scanner with an 10-pin modular connector. When properly seated, the connector is held in the scanner's handle by a flexible retention tab. The interface cable is designed to be field replaceable.

- Order replacement cables from Honeywell or from an authorized distributor.
- When ordering a replacement cable, specify the cable part number of the original interface cable.

Replace an Interface Cable

1. Turn off the power to the host system.
2. Disconnect the scanner's cable from the terminal or computer.
3. Locate the small hole on the back of the scanner's handle. This is the cable release.
4. Straighten one end of a paper clip.
5. Insert the end of the paper clip into the small hole and press in. This depresses the retention tab, releasing the connector. Pull the connector out while maintaining pressure on the paper clip, then remove the paper clip.
6. Replace with the new cable.
Insert the connector into the opening and press firmly. The connector is keyed to go in only one way, and will click into place.

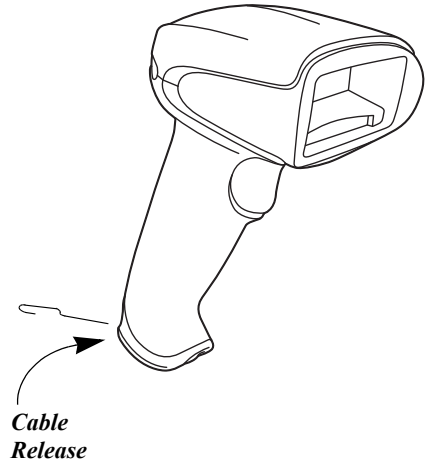

Replace Cables and Batteries in Cordless Systems

Replace an Interface Cable in a Base

1. Turn the power to the host system OFF.
2. Disconnect the base's cable from the terminal or computer.
3. Turn the base upside down.
4. Pull the connector out while maintaining pressure on the connector release clip.

**CCB01-010BT
Base:**

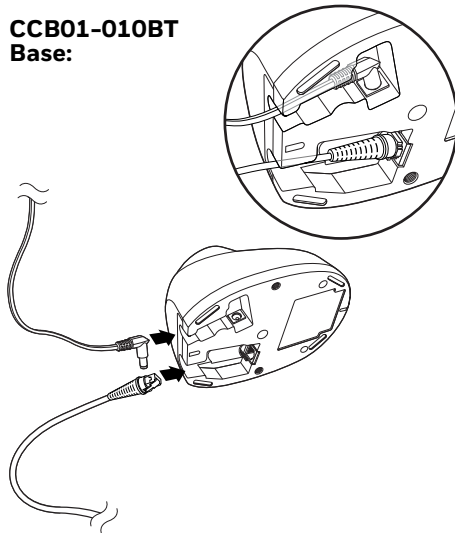

CCB-H-010BT Base:

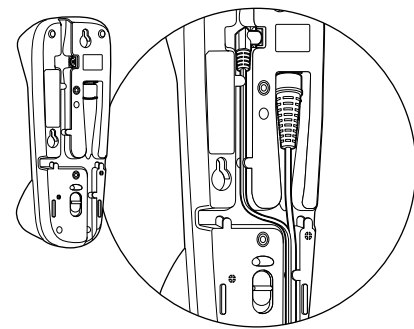

5. Replace with the new cable. Insert the connector into the opening and press firmly. The connector is keyed to go in only one way, and will click into place.

Change a Scanner Battery

1. Grasp the wing connector or use a Phillips head screwdriver to remove the screw from the end cap.
2. Remove the end cap and remove the battery from the handle.
3. Insert replacement battery.
4. Replace end cap and screw together.



Troubleshoot a Corded Scanner

The scanner automatically performs self-tests whenever you turn it on. If your scanner is not functioning properly, review the following Troubleshooting Guide to try to isolate the problem.

Is the power on? Is the aimer on?

If the aimer isn't illuminated, check that:

- The cable is connected properly.
- The host system power is on (if external power isn't used).
- The trigger works.

Is the scanner having trouble reading your symbols?

If the scanner isn't reading symbols well, check that the symbols:

- Aren't smeared, rough, scratched, or exhibiting voids.
- Aren't coated with frost or water droplets on the surface.
- Are enabled in the scanner or in the decoder to which the scanner connects.

Is the barcode displayed but not entered?

The barcode is displayed on the host device correctly, but you still have to press a key to enter it (the Enter/Return key or the Tab key, for example).

- You need to program a suffix. Programming a suffix enables the scanner to output the barcode data plus the key you need (such as "CR") to enter the data

into your application. Refer to [Prefix/Suffix Overview](#) on page 125 for further information.

If you aren't sure what programming options have been set in the scanner, or if you want the factory default settings restored, refer to [Reset the Factory Defaults](#) on page 238.

Troubleshoot a Cordless System

Troubleshoot a Base

Note: Go to sps.honeywell.com and then select **Support > Software and Downloads** to check for the latest software for both the scanner and the base.

If your base is not functioning properly, review the following troubleshooting guidelines to try to isolate the problem.

Is the red LED on?

If the red LED isn't illuminated, check that:

- The power cable is connected properly and there is power at the power source.
- The host system power is on (if external power isn't used).

Is the green LED on?

If the green LED isn't illuminated, check that:

- The scanner is correctly placed in the base.
- There is external power or 12 volt host power.
- Charge mode is turned on. (See "[Beeper and LED Sequences and Meaning](#)" on page 48)
- The battery is not bad or deeply discharged. In some cases, the scanner's battery may trickle charge to bring it into an acceptable level and then transition to a normal charge cycle.

Troubleshoot a Cordless Scanner

Note: Make sure that your scanner's battery is charged. Go to sps.honeywell.com and then select **Support > Software and Downloads** to check for the latest software for both the scanner and the base. to check for the latest software for both the scanner and the base or Access Point.

Is the scanner having trouble reading your symbols?

If the scanner isn't reading symbols well, check that the symbols:

- Aren't smeared, rough, scratched, or exhibiting voids.

- Aren't coated with frost or water droplets on the surface.
- Are enabled in the base or Access Point to which the scanner connects.

Is the barcode displayed but not entered into the application?

The barcode is displayed on the host device correctly, but you still have to press a key to enter it (the Enter/Return key or the Tab key, for example).

- You need to program a suffix. Programming a suffix enables the scanner to output the barcode data plus the key you need (such as "CR") to enter the data into your application. Refer to [Prefix/Suffix Overview](#) on page 125 for further information.

The scanner won't read your barcode at all.

- Scan the sample barcodes in the back of this manual. If the scanner reads the sample barcodes, check that your barcode is readable.
- Verify that your barcode symbology is enabled (see [Chapter 8](#)).

REFERENCE CHARTS

Symbology Charts

Note: “m” represents the AIM modifier character. Refer to *International Technical Specification, Symbology Identifiers*, for AIM modifier character details.

Prefix/Suffix entries for specific symbologies override the universal (All Symbologies, 99) entry.

Refer to [Data Edit](#) beginning on page 125 and [Data Format](#) beginning on page 131 for information about using Code ID and AIM ID.

Linear Symbologies

Linear Symbology	AIM		Honeywell	
	ID	Possible modifiers (m)	ID	Hex
All Symbologies				99
Codabar	JFm	0-1	a	61
Code 11	JH3		h	68
Code 128	JCm	0, 1, 2, 4	j	6A
Code 32 Pharmaceutical (PARAF)	JX0		<	3C
Code 39 (supports Full ASCII mode)	JAm	0, 1, 3, 4, 5, 7	b	62
TCIF Linked Code 39 (TLC39)	JL2		T	54
Code 93 and 93i	JGm	0-9, A-Z, a-m	i	69
EAN	JEm	0, 1, 3, 4	d	64
EAN-13 (including Bookland EAN)	JE0		d	64
EAN-13 with Add-On	JE3		d	64
EAN-13 with Extended Coupon Code	JE3		d	64
EAN-8	JE4		D	44

Linear Symbology	AIM		Honeywell	
	ID	Possible modifiers (m)	ID	Hex
EAN-8 with Add-On	JE3		D	44
GS1				
GS1 DataBar	jem	0	y	79
GS1 DataBar Limited	jem		{	7B
GS1 DataBar Expanded	jem		}	7D
GS1-128	JC1		l	49
2 of 5				
China Post (Hong Kong 2 of 5)	JX0		Q	51
Interleaved 2 of 5	Jlm	0, 1, 3	e	65
Matrix 2 of 5	JX0		m	6D
NEC 2 of 5	JX0		Y	59
Straight 2 of 5 IATA	JRm	0, 1, 3	f	66
Straight 2 of 5 Industrial	JS0		f	66
MSI	JMm	0, 1	g	67
Telepen	JBm		t	74
UPC		0, 1, 2, 3, 8, 9, A, B, C		
UPC-A	JE0		c	63
UPC-A with Add-On	JE3		c	63
UPC-A with Extended Coupon Code	JE3		c	63
UPC-E	JE0		E	45
UPC-E with Add-On	JE3		E	45
UPC-E1	JX0		E	45

Add Honeywell Code ID				5C80
Add AIM Code ID				5C81
Add Backslash				5C5C
Batch mode quantity			5	35

2D Symbologies

2D Symbology	AIM		Honeywell	
	ID	Possible modifiers (m)	ID	Hex
All Symbologies				99
Aztec Code]zm	0-9, A-C	z	7A

2D Symbology	AIM		Honeywell	
	ID	Possible modifiers (m)	ID	Hex
Chinese Sensible Code (Han Xin Code)]X0		H	48
Codablock A]06	0, 1, 4, 5, 6	V	56
Codablock F]0m	0, 1, 4, 5, 6	q	71
Code 49]Tm	0, 1, 2, 4	l	6C
Data Matrix]dm	0-6	w	77
Dot Code]J0		.	2E
GS1]em	0-3	y	79
GS1 Composite]em	0-3	y	79
GS1 DataBar Omnidirectional]em	0-3	y	79
MaxiCode]Um	0-3	x	78
PDF417]Lm	0-2	r	72
MicroPDF417]Lm	0-5	R	52
QR Code]Qm	0-6	s	73
Micro QR Code]Qm		s	73

Postal Symbologies

Postal Symbology	AIM		Honeywell	
	ID	Possible modifiers (m)	ID	Hex
All Symbologies				99
Australian Post]X0		A	41
British Post]X0		B	42
Canadian Post]X0		C	43
China Post]X0		Q	51
InfoMail]X0		,	2c
Intelligent Mail Barcode]X0		M	4D
Japanese Post]X0		J	4A
KIX (Netherlands) Post]X0		K	4B
Korea Post]X0		?	3F
Planet Code]X0		L	4C
Postal-4i]X0		N	4E
Postnet]X0		P	50

ASCII Conversion Chart (Code Page 1252)

In keyboard applications, ASCII Control Characters can be represented in 3 different ways, as shown below. The CTRL+X function is OS and application dependent. The following table lists some commonly used Microsoft functionality. This table applies to U.S. style keyboards. Certain characters may differ depending on your Country Code/PC regional settings.

Non-printable ASCII control characters			Keyboard Control + ASCII (CTRL+X) Mode		
DEC	HEX	Char	Control + X Mode Off (KBDCAS0)	Windows Mode Control + X Mode On (KBDCAS2)	
				CTRL + X	CTRL + X function
0	00	NUL	Reserved	CTRL+ @	
1	01	SOH	NP Enter	CTRL+ A	Select all
2	02	STX	Caps Lock	CTRL+ B	Bold
3	03	ETX	ALT Make	CTRL+ C	Copy
4	04	EOT	ALT Break	CTRL+ D	Bookmark
5	05	ENQ	CTRL Make	CTRL+ E	Center
6	06	ACK	CTRL Break	CTRL+ F	Find
7	07	BEL	Enter / Ret	CTRL+ G	
8	08	BS	<i>(Apple Make)</i>	CTRL+ H	History
9	09	HT	Tab	CTRL+ I	Italic
10	0A	LF	<i>(Apple Break)</i>	CTRL+ J	Justify
11	0B	VT	Tab	CTRL+ K	hyperlink
12	0C	FF	Delete	CTRL+ L	list, left align
13	0D	CR	Enter / Ret	CTRL+ M	
14	0E	SO	Insert	CTRL+ N	New
15	0F	SI	ESC	CTRL+ O	Open
16	10	DLE	F11	CTRL+ P	Print
17	11	DC1	Home	CTRL+ Q	Quit
18	12	DC2	PrtScn	CTRL+ R	
19	13	DC3	Backspace	CTRL+ S	Save
20	14	DC4	Back Tab	CTRL+ T	
21	15	NAK	F12	CTRL+ U	
22	16	SYN	F1	CTRL+ V	Paste
23	17	ETB	F2	CTRL+ W	
24	18	CAN	F3	CTRL+ X	
25	19	EM	F4	CTRL+ Y	
26	1A	SUB	F5	CTRL+ Z	
27	1B	ESC	F6	CTRL+ [
28	1C	FS	F7	CTRL+ \	
29	1D	GS	F8	CTRL+]	
30	1E	RS	F9	CTRL+ ^	
31	1F	US	F10	CTRL+ -	
127	7F	␣	NP Enter		

Lower ASCII Reference Table

Note: Windows Code page 1252 and lower ASCII use the same characters.

Printable Characters								
DEC	HEX	Character	DEC	HEX	Character	DEC	HEX	Character
32	20	<SPACE>	64	40	@	96	60	`
33	21	!	65	41	A	97	61	a
34	22	"	66	42	B	98	62	b
35	23	#	67	43	C	99	63	c
36	24	\$	68	44	D	100	64	d
37	25	%	69	45	E	101	65	e
38	26	&	70	46	F	102	66	f
39	27	'	71	47	G	103	67	g
40	28	(72	48	H	104	68	h
41	29)	73	49	I	105	69	i
42	2A	*	74	4A	J	106	6A	j
43	2B	+	75	4B	K	107	6B	k
44	2C	,	76	4C	L	108	6C	l
45	2D	-	77	4D	M	109	6D	m
46	2E	.	78	4E	N	110	6E	n
47	2F	/	79	4F	O	111	6F	o
48	30	0	80	50	P	112	70	p
49	31	1	81	51	Q	113	71	q
50	32	2	82	52	R	114	72	r
51	33	3	83	53	S	115	73	s
52	34	4	84	54	T	116	74	t
53	35	5	85	55	U	117	75	u
54	36	6	86	56	V	118	76	v
55	37	7	87	57	W	119	77	w
56	38	8	88	58	X	120	78	x
57	39	9	89	59	Y	121	79	y
58	3A	:	90	5A	Z	122	7A	z
59	3B	;	91	5B	[123	7B	{
60	3C	<	92	5C	\	124	7C	
61	3D	=	93	5D]	125	7D	}
62	3E	>	94	5E	^	126	7E	~
63	3F	?	95	5F	_	127	7F	△

Extended ASCII Characters					
DEC	HEX	CP 1252	ASCII	Alternate Extended	PS2 Scan Code
128	80	€	Ç	up arrow ↑	0x48
129	81		ü	down arrow ↓	0x50
130	82	,	é	right arrow →	0x4B
131	83	f	â	left arrow ←	0x4D
132	84	„	ä	Insert	0x52
133	85	…	à	Delete	0x53
134	86	†	å	Home	0x47
135	87	‡	ç	End	0x4F
136	88	^	ê	Page Up	0x49
137	89	‰	ë	Page Down	0x51
138	8A	Š	è	Right ALT	0x38
139	8B	<	ï	Right CTRL	0x1D

Extended ASCII Characters (Continued)

DEC	HEX	CP 1252	ASCII	Alternate Extended	PS2 Scan Code
140	8C	Œ	î	Reserved	n/a
141	8D		ï	Reserved	n/a
142	8E	Ž	Ā	Numeric Keypad Enter	0x1C
143	8F		Ă	Numeric Keypad /	0x35
144	90		É	F1	0x3B
145	91	‘	æ	F2	0x3C
146	92	’	Æ	F3	0x3D
147	93	“	ô	F4	0x3E
148	94	”	ö	F5	0x3F
149	95	•	ò	F6	0x40
150	96	–	û	F7	0x41
151	97	—	ù	F8	0x42
152	98	˜	ÿ	F9	0x43
153	99	™	Ö	F10	0x44
154	9A	š	Ü	F11	0x57
155	9B	›	ç	F12	0x58
156	9C	œ	£	Numeric Keypad +	0x4E
157	9D		¥	Numeric Keypad -	0x4A
158	9E	ž	Ps	Numeric Keypad *	0x37
159	9F	ÿ	f	Caps Lock	0x3A
160	A0		á	Num Lock	0x45
161	A1	ı	í	Left Alt	0x38
162	A2	ç	ó	Left Ctrl	0x1D
163	A3	£	ú	Left Shift	0x2A
164	A4	¤	ñ	Right Shift	0x36
165	A5	¥	Ñ	Print Screen	n/a
166	A6	ı	ª	Tab	0x0F
167	A7	§	º	Shift Tab	0x8F
168	A8	¨	¿	Enter	0x1C
169	A9	©	ƒ	Esc	0x01
170	AA	ª	¬	Alt Make	0x36
171	AB	«	½	Alt Break	0xB6
172	AC	¬	¼	Control Make	0x1D
173	AD		ı	Control Break	0x9D
174	AE	®	«	Alt Sequence with 1 Character	0x36
175	AF	™	»	Ctrl Sequence with 1 Character	0x1D
176	B0	°	␣		
177	B1	±	␣		
178	B2	²	␣		
179	B3	³	␣		
180	B4	´	␣		
181	B5	µ	␣		
182	B6	¶	␣		
183	B7	·	␣		
184	B8	¸	␣		
185	B9	¹	␣		
186	BA	º	␣		
187	BB	»	␣		
188	BC	¼	␣		
189	BD	½	␣		
190	BE	¾	␣		
191	BF	¿	␣		
192	C0	À	␣		
193	C1	Á	␣		

Extended ASCII Characters (Continued)					
DEC	HEX	CP 1252	ASCII	Alternate Extended	PS2 Scan Code
194	C2	Â	T		
195	C3	Ã	†		
196	C4	Ä	—		
197	C5	Å	í		
198	C6	Æ	‡		
199	C7	Ç	‡		
200	C8	È	‡		
201	C9	É	‡		
202	CA	Ê	‡		
203	CB	Ë	‡		
204	CC	Ì	‡		
205	CD	Í	=		
206	CE	Î	‡		
207	CF	Ï	‡		
208	D0	Ð	‡		
209	D1	Ñ	‡		
210	D2	Ò	‡		
211	D3	Ó	‡		
212	D4	Ô	‡		
213	D5	Õ	F		
214	D6	Ö	‡		
215	D7	×	‡		
216	D8	Ø	‡		
217	D9	Ù	J		
218	DA	Ú	‡		
219	DB	Û	■		
220	DC	Ü	■		
221	DD	Ý	■		
222	DE	Þ	■		
223	DF	ß	■		
224	E0	à	α		
225	E1	á	β		
226	E2	â	Γ		
227	E3	ã	π		
228	E4	ä	Σ		
229	E5	å	σ		
230	E6	æ	μ		
231	E7	ç	τ		
232	E8	è	Φ		
233	E9	é	Θ		
234	EA	ê	Ω		
235	EB	ë	δ		
236	EC	ì	∞		
237	ED	í	φ		
238	EE	î	ε		
239	EF	ï	∩		
240	F0	ð	≡		
241	F1	ñ	±		
242	F2	ò	≥		
243	F3	ó	≤		
244	F4	ô			
245	F5	õ]		
246	F6	ö	+		
247	F7	÷	≈		

Extended ASCII Characters (Continued)					
DEC	HEX	CP 1252	ASCII	Alternate Extended	PS2 Scan Code
248	F8	ø	°		
249	F9	ù	·		
250	FA	ú	·		
251	FB	û	√		
252	FC	ü	ñ		
253	FD	ý	²		
254	FE	þ	■		
255	FF	ÿ			

ISO 2022/ISO 646 Character Replacements

Code pages define the mapping of character codes to characters. If the data received does not display with the proper characters, it may be because the barcode being scanned was created using a code page that is different from the one the host program is expecting. If this is the case, select the code page with which the barcodes were created. The data characters should then appear properly.

Code Page Selection Method/ Country	Standard	Keyboard Country	Honeywell Code Page Option
United States (standard ASCII)	ISO/IEC 646-IRV	n/a	1
Automatic National Character Replacement	ISO/IEC 2022	n/a	2 (default)
Binary Code page	n/a	n/a	3
Default "Automatic National Character replacement" will select the below Honeywell Code Page options for Code128, Code 39 and Code 93.			
United States	ISO/IEC 646-06	0	1
Canada	ISO /IEC 646-121	54	95
Canada	ISO /IEC 646-122	18	96
Japan	ISO/IEC 646-14	28	98
China	ISO/IEC 646-57	92	99
Great Britain (UK)	ISO /IEC 646-04	7	87
France	ISO /IEC 646-69	3	83
Germany	ISO/IEC646-21	4	84
Switzerland	ISO /IEC 646-CH	6	86
Sweden / Finland (extended Annex C)	ISO/IEC 646-11	2	82
Ireland	ISO /IEC 646-207	73	97
Denmark	ISO/IEC 646-08	8	88
Norway	ISO/IEC 646-60	9	94
Italy	ISO/IEC 646-15	5	85
Portugal	ISO/IEC 646-16	13	92

Code Page Selection Method/ Country	Standard	Keyboard Country	Honeywell Code Page Option
Spain	ISO/IEC 646-17	10	90
Spain	ISO/IEC 646-85	51	91

Dec			35	36	64	91	92	93	94	96	123	124	125	126
Hex			23	24	40	5B	5C	5D	5E	60	7B	7C	7D	7E
US	0	1	#	\$	@	[\]	^	`	{		}	~
CA	54	95	#	\$	à	â	ç	ê	î	ô	é	ù	è	û
CA	18	96	#	\$	à	â	ç	ê	É	ô	é	ù	è	û
JP	28	98	#	\$	@	[¥]	^	`	{		}	-
CN	92	99	#	¥	@	[\]	^	`	{		}	-
GB	7	87	£	\$	@	[\]	^	`	{		}	~
FR	3	83	£	\$	à	°	ç	§	^	μ	é	ù	è	¨
DE	4	84	#	\$	§	Ä	Ö	Ü	^	`	ä	ö	ü	ß
CH	6	86	ù	\$	à	é	ç	ê	î	ô	ä	ö	ü	û
SE/FI	2	82	#	¤	É	Ä	Ö	Å	Ü	é	ä	ö	å	ü
DK	8	88	#	\$	@	Æ	Ø	Å	^	`	æ	ø	å	~
NO	9	94	#	\$	@	Æ	Ø	Å	^	`	æ	ø	å	-
IE	73	97	£	\$	Ó	É	Í	Ú	Á	ó	é	í	ú	á
IT	5	85	£	\$	§	°	ç	é	^	ù	à	ò	è	ì
PT	13	92	#	\$	§	Ã	Ç	Õ	^	`	ã	ç	õ	°
ES	10	90	#	\$	§	i	Ñ	¿	^	`	°	ñ	ç	~
ES	51	91	#	\$	·	i	Ñ	Ç	¿	`	´	ñ	ç	¨
COUNTRY	Country Keyboard	Honeywell CodePage	ISO / IEC 646 National Character Replacements											

Keyboard Key References

6E	70	71	72	73	74	75	76	77	78	79	7A	7B	7C	7D	7E					
01	02	03	04	05	06	07	08	09	0A	0B	0C	0D	0F	4B	50	55	5A	5F	64	69
10	11	12	13	14	15	16	17	18	19	1A	1B	1C	1D	4C	51	56	5B	60	65	6A
1E	1F	20	21	22	23	24	25	26	27	28	29	2B				53	5C	61	66	
2C	2E	2F	30	31	32	33	34	35	36	37	39			4F	54	59	5D	62	67	6C
3A	3B	3C			3D				3E	3F	38	40					63	68		

104 Key U.S. Style Keyboard

6E	70	71	72	73	74	75	76	77	78	79	7A	7B	7C	7D	7E					
01	02	03	04	05	06	07	08	09	0A	0B	0C	0D	0F	4B	50	55	5A	5F	64	69
10	11	12	13	14	15	16	17	18	19	1A	1B	1C	2B	4C	51	56	5B	60	65	6A
1E	1F	20	21	22	23	24	25	26	27	28	29	2A				53	5C	61	66	
2C	2D	2E	2F	30	31	32	33	34	35	36	37	39		4F	54	59	5D	62	67	6C
3A	3B	3C			3D				3E	3F	38	40					63	68		

105 Key European Style Keyboard

SAMPLE SYMBOLS

UPC-A

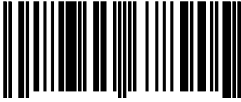

0 123456 7890

Interleaved 2 of 5

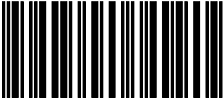

01234567890

EAN-13



9 780330 290951

Code 128

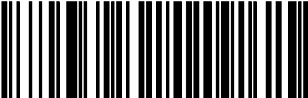

Code 128

Code 39

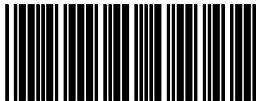

BC321

Codabar



A13579B

Code 93



123456-9\$

Straight 2 of 5 Industrial

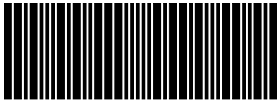

123456

Matrix 2 of 5



6543210

RSS-14



(01) 00123456789012

PDF417



Car Registration

Code 49



1234567890

SAMPLE SYMBOLS (CONTINUED)

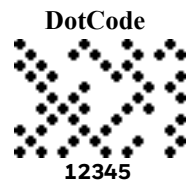
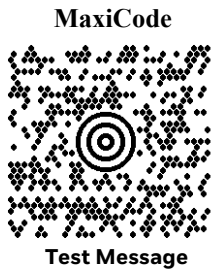

PROGRAMMING CHART



K0K
0



K2K
2



K4K
4



K6K
6



K8K
8



K1K
1



K3K
3



K5K
5



K7K
7



K9K
9

PROGRAMMING CHART (CONTINUED)



KAK
A



KBK
B



KCK
C



KDK
D



KEK
E



KFK
F



MNUSAV.
Save



MNUABT.
Discard



RESET_
Reset

Note: If you make an error while scanning the letters or digits (before scanning **Save**), scan **Discard**, scan the correct letters or digits, and **Save** again.

Honeywell
855 S. Mint Street
Charlotte, NC 28202

sps.honeywell.com