

Datalogic S.r.l.
Via S. Vitalino, 13
40012 Calderara di Reno (BO)
Italy
Tel. +39 051 3147011
Fax +39 051 3147205

©2011-2018 Datalogic S.p.A. and/or its affiliates

An Unpublished Work - All rights reserved. No part of the contents of this documentation or the procedures described therein may be reproduced or transmitted in any form or by any means without prior written permission of Datalogic S.p.A. and/or its affiliates. Owners of Datalogic products are hereby granted a non-exclusive, revocable license to reproduce and transmit this documentation for the purchaser's own internal business purposes. Purchaser shall not remove or alter any proprietary notices, including copyright notices, contained in this documentation and shall ensure that all notices appear on any reproductions of the documentation. Should future revisions of this manual be published, you can acquire printed versions by contacting your Datalogic representative. Electronic versions may either be downloadable from the Datalogic website (www.datalogic.com) or provided on appropriate media. If you visit our website and would like to make comments or suggestions about this or other Datalogic publications, please let us know via the "Contact Datalogic" page.

Disclaimer

Datalogic has taken reasonable measures to provide information in this manual that is complete and accurate, however, Datalogic reserves the right to change any specification at any time without prior notice. Datalogic and the Datalogic logo are registered trademarks of Datalogic S.p.A. in many countries, including the U.S. and the E.U. Gryphon is a trademark of Datalogic S.p.A. and/or its affiliates, registered in the U.S. All other brand and product names may be trademarks of their respective owners.

Patents

See www.patents.datalogic.com for patent list.

This product is covered by one or more of the following patents:

Design patents: EP004032241
Utility patents: EP0996284B1, EP0999514B1, EP1114390B1, EP1128315B1, EP1396811B1, EP1413971B1, EP1825417B1, EP1828957B1, EP2275966B1, EP2517148B1, EP2521068B1, EP2649555B1, JP4435343B2, US6478224, US6512218, US6513714, US6561427, US6808114, US6997385, US7053954, US7234641, US7387246, US7721966, US8245926, US8561906, US8888003, US8915443, US9430689, ZL2009801634.11.X

DATALOGIC

Gryphon™ I GD4500

General Purpose Corded Handheld Area Imager Bar Code Reader



Regulatory Addendum



This document is an addendum to the Quick Reference Guide (QRG) for this product. See the QRG for additional product information.

©2018 Datalogic S.p.A. and/or its affiliates • All rights reserved. Datalogic and the Datalogic logo are registered trademarks of Datalogic S.p.A. in many countries, including the U.S.A. and the E.U.

DATALOGIC

www.datalogic.com

Regulatory Information

All models are designed to be compliant with rules and regulations in locations they are sold and will be labeled as required. Any changes or modifications to equipment, not expressly approved by Datalogic could void the user's authority to operate the equipment.

Statement of Agency Compliance

This device complies with part 15 of the FCC Rules. Operation is subject to the following two conditions: (1) this device may not cause harmful interference, and (2) this device must accept any interference received, including interference that may cause undesired operation.

FCC Class B Compliance Statement

The user is cautioned that changes or modifications not expressly approved by the part responsible for compliance could void the user's authority to operate the equipment.

This equipment has been tested and found to comply with the limits for a Class B digital device pursuant to part 15 of the FCC Rules. These limits are designed to provide reasonable protection against harmful interference in a residential installation. This equipment generates, uses, and can radiate radio frequency energy and, if not installed and used in accordance with the instructions, may cause harmful interference to radio communications. However, there is no guarantee that interference will not occur in a particular installation. If this equipment does cause harmful interference to radio or television reception, which can be determined by turning the equipment off and on, the user is encouraged to try to correct the interference by one or more of the following measures:

- Reorient or relocate the receiving antenna.
- Increase the separation between the equipment and receiver.
- Connect the equipment into an outlet on a circuit different from that to which the receiver is connected.
- Consult the dealer or an experienced radio or television technician for help.

Canadian Notice

This equipment does not exceed the Class B limits for radio noise emissions as described in the Radio Interference Regulations of the Canadian Department of Communications.

Le présent appareil numérique n'émet pas de bruits radioélectriques dépassant les limites applicables aux appareils numériques de la classe B prescrites dans le Règlement sur le brouillage radioélectrique édicté par le ministère des Communications du Canada.



Do not attempt to open or otherwise service any components in the optics cavity. Opening or servicing any part of the optics cavity by unauthorized personnel may violate laser safety regulations.

Customs Union

The CU conformity certification has been achieved; this allows the Product to bear the Eurasian mark of conformity.

EAC

Power Supply

This device is intended to be connected to a UL Listed/CSA Certified computer which supplies power directly to the reader or else be supplied by UL Listed/CSA Certified Power Unit marked 'Class 2' or LPS power source rated 5-14V minimum 900mA.

Power Supply

This device is intended to be connected to a UL Listed/CSA Certified computer which supplies power directly to the reader or else be supplied by UL Listed/CSA Certified Power Unit marked 'Class 2' or LPS power source rated 5-14V minimum 900mA.

Argentina Power Statement

Características de la fuente de alimentación eléctrica.	
Atención	
	Entrada: 100 - 240 Vca min 0.35A 50-60 Hz
	Salida: +5VDC, máx 2.5A (-)Negativo al centro
	Entrada: 100 - 240 Vca min 600mA 50-60 Hz
	Salida: 12VDC, máx1500mA (-)Negativo al centro

Utilice en su red solo fuentes certificadas en Argentina.
El uso de fuentes de alimentación no compatibles puede resultar en riesgo de incendio o de choque eléctrico para el usuario.

Labeling

Sample labels are shown here to illustrate their location only. Please view the labels on your product for actual details, as they may vary from those depicted. The Gryphon™ laser system meets the Class 2 requirements for laser safety. The laser information is located on the product label.

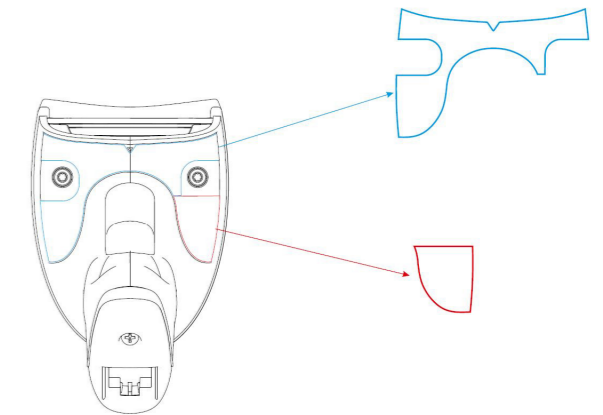

I D F E

LA LUCE LASER È VISIBILE ALL'OCCHIO UMANO E VIENE EMESSA DALLA FINESTRA INDICATA NELLA FIGURA.

DIE LASER-STRALHUNG IST FÜR DAS MENSCHLICHE AUGE SICHTBAR UND WIRD AM STRAHLAUS TRITTSFENSTER AUSGESENDET (SIEHE BILD).

LE RAYON LASER EST VISIBLE À L'OEIL NU ET IL EST ÉMIS PAR LA FENÊTRE DÉSIGNÉE EN LA FIGURA.

A LUZ LÁSER ES VISIBLE AL OJO HUMANO Y ES EMITIDA POR LA VENTANA INDICADA EN LA FIGURA.

LUCE LASER NON FISSARE IL FASCIO APPARECCHIO LASER DI CLASSE 2 MASSIMA POTENZA D'USCITA: LUNGHEZZA D'ONDA EMESSA: CONFORME A EN 60825-1 (2014).

LASERSTRALHUNG NICHT IN DEN STRAHL BLICKEN PRODUKT DER LASERKLASSE 2 MAXIMALE AUSGANGSLEISTUNG: WELLENLÄGE: ENTSPR. EN 60825-1 (2014).

RAYON LASER EVITER REGARDER LE RAYON APPAREIL LASER DE CLASSE 2 PUISSANCE DE SORTIE: LONGUEUR D'ONDE EMISE: CONFORME A EN 60825-1 (2014).

RAYO LÁSER NO MIRAR FIJO EL RAYO APARATO LÁSER DE CLASE 2 MÁXIMA POTENCIA DE SALIDA: LONGITUD DE ONDA EMITIDA: CONFORME A EN 60825-1 (2014).

ENGLISH

The following information is provided to comply with the rules imposed by international authorities and refers to the correct use of your terminal.

STANDARD LASER SAFETY REGULATIONS

This product conforms to the applicable requirements of both CDRH 21 CFR 1040 and EN 60825-1 at the date of manufacture.

For installation, use and maintenance, it is not necessary to open the device.

 **Use of controls or adjustments or performance of procedures other than those specified herein may result in exposure to hazardous visible laser light.**

WARNING

The product utilizes a low-power laser diode. Although staring directly at the laser beam momentarily causes no known biological damage, avoid staring at the beam as one would with any very strong light source, such as the sun. Avoid that the laser beam hits the eye of an observer, even through reflective surfaces such as mirrors, etc.

ITALIANO

Le seguenti informazioni vengono fornite dietro direttive delle autorità internazionali e si riferiscono all'uso corretto del terminale.

NORMATIVE STANDARD PER LA SICUREZZA LASER

Questo prodotto risulta conforme alle normative vigenti sulla sicurezza laser alla data di produzione: CDRH 21 CFR 1040 e EN 60825-1.

Non si rende mai necessario aprire l'apparecchio per motivi di installazione, utilizzo o manutenzione.

 **L'utilizzo di procedure o regolazioni differenti da quelle descritte nella documentazione può provocare un'esposizione pericolosa a luce laser visibile.**

ATTENZIONE

Il prodotto utilizza un diodo laser a bassa potenza. Sebbene non siano noti danni riportati dall'occhio umano in seguito ad una esposizione di breve durata, evitare di fissare il raggio laser così come si eviterebbe qualsiasi altra sorgente di luminosità intensa, ad esempio il sole. Evitare inoltre di dirigere il raggio laser negli occhi di un osservatore, anche attraverso superfici riflettenti come gli specchi.

DEUTSCH

Die folgenden Informationen stimmen mit den Sicherheitshinweisen überein, die von internationalen Behörden auferlegt wurden, und sie beziehen sich auf den korrekten Gebrauch vom Terminal.

NORM FÜR DIE LASERSICHERHEIT

Dies Produkt entspricht am Tag der Herstellung den gültigen EN 60825-1 und CDRH 21 CFR 1040 Normen für die Lasersicherheit.

Es ist nicht notwendig, das Gerät wegen Betrieb oder Installations-, und Wartungs-Arbeiten zu öffnen.

 **Jegliche Änderungen am Gerät sowie Vorgehensweisen, die nicht in dieser Betriebsanleitung beschreiben werden, können ein gefährliches Laserlicht verursachen.**

ACHTUNG

Der Produkt benutzt eine Laserdiode. Obwohl zur Zeit keine Augenschäden von kurzen Einstrahlungen bekannt sind, sollten Sie es vermeiden für längere Zeit in den Laserstrahl zu schauen, genauso wenig wie in starke Lichtquellen (z.B. die Sonne). Vermeiden Sie es, den Laserstrahl weder gegen die Augen eines Beobachters, noch gegen reflektierende Oberflächen zu richten.

FRANÇAIS

Les informations suivantes sont fournies selon les règles fixées par les autorités internationales et se réfèrent à une correcte utilisation du terminal.

NORMES DE SECURITE LASER

Ce produit est conforme aux normes de sécurité laser en vigueur à sa date de fabrication: CDRH 21 CFR 1040 et EN 60825-1.

Il n'est pas nécessaire d'ouvrir l'appareil pour l'installation, l'utilisation ou l'entretien.

 **L'utilisation de procédures ou réglages différents de ceux donnés ici peut entraîner une dangereuse exposition à lumière laser visible.**

ATTENTION

Le produit utilise une diode laser. Aucun dommage aux yeux humains n'a été constaté à la suite d'une exposition au rayon laser. Eviter de regarder fixement le rayon, comme toute autre source lumineuse intense telle que le soleil. Eviter aussi de diriger le rayon vers les yeux d'un observateur, même à travers des surfaces réfléchissantes (miroirs, par exemple).

ESPAÑOL

Las informaciones siguientes son presentadas en conformidad con las disposiciones de las autoridades internacionales y se refieren al uso correcto del terminal.

NORMATIVAS ESTÁNDAR PARA LA SEGURIDAD LÁSER

Este aparato resulta conforme a las normativas vigentes de seguridad láser a la fecha de producción: CDRH 21 CFR 1040 y EN 60825-1.

No es necesario abrir el aparato para la instalación, la utilización o la manutención.

 **La utilización de procedimientos o regulaciones diferentes de aquellas descritas en la documentación puede causar una exposición peligrosa a la luz láser visible.**

ATENCIÓN

El aparato utiliza un diodo láser a baja potencia. No son notorios daños a los ojos humanos a consecuencia de una exposición de corta duración. Eviten de mirar fijo el rayo láser así como evitarían cualquiera otra fuente de luminosidad intensa, por ejemplo el sol. Además, eviten de dirigir el rayo láser hacia los ojos de un observador, también a través de superficies reflectantes como los espejos.

 **The Gryphon™ Handheld Reader is not user-serviceable. Opening the case of the unit can cause internal damage and will void the warranty.**

CAUTION

WEEE Statement

 **Waste Electrical and Electronic Equipment (WEEE) Statement**

English

For information about the disposal of Waste Electrical and Electronic Equipment (WEEE), please refer to the website at www.datalogic.com.

Italian

Per informazioni sullo smaltimento delle apparecchiature elettriche ed elettroniche consultare il sito Web www.datalogic.com.

French

Pour toute information relative à l'élimination des déchets électroniques (WEEE), veuillez consulter le site internet www.datalogic.com.

German

Informationen zur Entsorgung von Elektro- und Elektronik- Altgeräten (WEEE) erhalten Sie auf der Webseite www.datalogic.com.

Spanish

Si desea información acerca de los procedimientos para el desecho de los residuos del equipo eléctrico y electrónico (WEEE), visite la página Web www.datalogic.com.

Portuguese

Para informações sobre a disposição de Sucatagem de Equipamentos Elétricos e Eletrônicos (WEEE -Waste Electrical and Electronic Equipment), consultar o site web www.datalogic.com.

Chinese

有关处理废弃电气电子设备 (WEEE) 的信息, 请参考 Datalogic 公司的网站 www.datalogic.com。

Japanese

廃電気電子機器 (WEEE) の処理についての関連事項は Datalogic のサイト www.datalogic.com をご参照下さい。

CHINA ROHS TABLE OF RESTRICTED ELEMENTS

PART	China RoHS						
	Lead (Pb)	Mercury (Hg)	Cadmium (Cd)	Hexavalent Chromium (Cr(VI))	Polybrominated Biphenyls (PBB)	Polybrominated Diphenyl ethers (PBDE)	
Cable				六价铬	多溴联苯	多溴二苯醚	
Printed Circuit Board Assembly	X						
Assy, Optics Block	X						
Assy, Module	X						

O: 代表此种部件的所有均质材料中所含的该种有毒有害物质均低于中华人民共和国信息产业部所颁布的《电子信息产品中有害物质含量的限量要求》(SJ/T 11363-2006) 规定的限量。

X: 代表此种部件所用的均质材料中, 至少有一类材料其所含的有毒有害物质高于中华人民共和国信息产业部所颁布的《电子信息产品中有害物质含量的限量要求》(SJ/T 11363-2006) 规定的限量。

EUFP determined by "Look-up Method" (scanner). 环保使用期限取决于“查表法”(扫描仪)

DATALOGIC

EU DECLARATION OF CONFORMITY
UE DICHIARAZIONE DI CONFORMITÀ
UE DECLARACIÓN DE CONFORMIDAD
UE DÉCLARATION DE CONFORMITÉ
EU KONFORMITÄTSERKLÄRUNG
EU KONFORMITÄTSVERKLÄRUNG
EU FÖRSÄKRAN OM ÖVERENSSTÄMMELSE

EC-601_0

CE

Apparatus / Apparato / Aparato / Appareil / Gerätetyp / Apparaatmodel / Apparatmodell

Gryphon GD4500 ; Barcode Reader

and all its models / e tutti i suoi modelli / y todos sus modelos / et tous ses modèles / und seine modelle / en al haar modellen / och alla sina modeller

Manufacturer / Produttore / Fabricante / Fabricant / Hersteller / Fabrikant / Tillverkaren

Datalogic S.r.l.
Via S. Vitalino 13, 40012 Lippo di Calderara (BO) - Italy

This declaration of conformity is issued under the sole responsibility of the manufacturer / La presente dichiarazione di conformità è rilasciata sotto la responsabilità esclusiva del fabbricante / La presente declaración de conformidad se expide bajo la exclusiva responsabilidad del fabricante / La présente déclaration de conformité est établie sous la seule responsabilité du fabricant / Die alleinige Verantwortung für die Ausstellung dieser onformatiserklärung trägt der Hersteller / Deze conformiteitsverklaring wordt verstrekt onder volledige verantwoordelijkheid van de fabrikant / Denna försäkran om överensstämmelse utfärdas på tillverkarens eget ansvar.

The object of the declaration described above is in conformity with the relevant Union harmonization legislation: / L'oggetto della dichiarazione di cui sopra è conforme alla pertinente normativa di armonizzazione dell'Unione: / El objeto de la declaración descrita anteriormente es conforme con la legislación de armonización pertinente de la Unión: / L'objet de la déclaration décrit ci-dessus est conforme à la législation d'harmonisation de l'Union applicable: / Der oben beschriebene Gegenstand der Erklärung erfüllt die einschlägigen Harmonisierungsrechtsvorschriften der Union: / Het hierboven beschreven voorwerp is in overeenstemming de desbetreffende harmonisatiewetgeving van de Unie: / Föremålet för försäkran ovan överensstämmer med den relevanta harmoniserade unionslagstiftningen:

2014/30/EU - EMC Directive
2011/65/EU - RoHS Directive

ferences to the relevant harmonised standards: / Riferimento alle pertinenti norme armonizzate: / ferencias a las normas armonizadas: / Références des normes harmonisées: / Angabe der ischlägigen harmonisierten Normen: / Vermelding van de toegepaste relevante geharmoniseerde rmen: / Hänvisningar till de relevanta harmoniserade standarder:

EN 55032, MAY 2015 **ELECTROMAGNETIC COMPATIBILITY OF MULTIMEDIA EQUIPMENT – EMISSION REQUIREMENTS**

EN 55024, NOVEMBER 2010: **INFORMATION TECHNOLOGY EQUIPMENT – IMMUNITY CHARACTERISTICS – LIMITS AND METHODS OF MEASUREMENT**

EN 50581, SEPT 2012 **TECHNICAL DOCUMENTATION FOR THE ASSESSMENT OF ELECTRICAL AND ELECTRONIC PRODUCTS WITH RESPECT TO THE RESTRICTION OF HAZARDOUS SUBSTANCES**

Lippo di Calderara,
June 13th 2018

Ruggero Cacioppo
Product Quality Leader