



**NLS-HR3280-BT**  
**NLS-HR3280-BT-HC**

**Wireless 2D Barcode Scanner**

**User Guide**

## Disclaimer

© 2019 Fujian Newland Auto-ID Tech. Co., Ltd. All rights reserved.

Please read through the manual carefully before using the product and operate it according to the manual. It is advised that you should keep this manual for future reference.

Do not disassemble the device or remove the seal label from the device, doing so will void the product warranty provided by Fujian Newland Auto-ID Tech. Co., Ltd.

All pictures in this manual are for reference only and actual product may differ. Regarding to the product modification and update, Fujian Newland Auto-ID Tech. Co., Ltd. reserves the right to make changes to any software or hardware to improve reliability, function, or design at any time without notice. The information contained herein is subject to change without prior notice.

The products depicted in this manual may include software copyrighted by Fujian Newland Auto-ID Tech. Co., Ltd or third party. The user, corporation or individual, shall not duplicate, in whole or in part, distribute, modify, decompile, disassemble, decode, reverse engineer, rent, transfer or sublicense such software without prior written consent from the copyright holders.

This manual is copyrighted. No part of this publication may be reproduced, distributed or used in any form without written permission from Newland.

Fujian Newland Auto-ID Tech. Co., Ltd. reserves the right to make final interpretation of the statement above.

Fujian Newland Auto-ID Tech. Co., Ltd.

No.1, Rujiang West Rd., Mawei, Fuzhou, Fujian, China 350015

<http://www.newlandaidc.com>

## Revision History

| Version | Description   | Date         |
|---------|---|--------------|
| V1.0.1  | Initial release.  | Mar 19, 2019 |
| V1.0.2  | Changed outline picture   | Mar 29, 2019 |
| V1.0.3  | Modified Factory Default Table and related descriptions   | Sep 3, 2019  |
| V1.0.4  | Added "Host Acknowledgment"   | Oct 8, 2019  |
| V1.0.5  | <ol style="list-style-type: none"> <li>Added Reminder Beep Volume and Power off/ Battery off in Chapter 3</li> <li>Added Comparison Command in Chapter 8</li> </ol>   | Dec 9, 2019  |
| V1.0.6  | <ol style="list-style-type: none"> <li>Added notes of Bluetooth HID Keyboard in Chapter 4</li> <li>Added Example in Set Scanner Name in Chapter 6</li> <li>Added Datalogic Magellan Aux-RS232 in Chapter 4</li> <li>Added Query Bluetooth Hardware Version and Query Cradle Bluetooth Hardware Version in Chapter 3</li> <li>Deleted Specific OCR-B in Chapter 7</li> <li>Added Transmit GS1 check character</li> <li>Added Automatically select UTF-8 or Code Page in PDF417, QR Code, Aztec, Data Matrix</li> </ol> <p>Note: Firmware version HR32-BT_V1.01.020 or later is required for the new feature above.</p> | Aug 10, 2020 |
| V1.0.7  | <ol style="list-style-type: none"> <li>Added RS-232 barcode in the Chapter 4.</li> <li>Added Bluetooth BLE and related description in the Chapter 6.</li> <li>Revised Set Date and Time in the Chapter 6.</li> </ol> <p>Note: Firmware version HR32-BT_V1.01.021 or later is required for the new feature above.</p>  | Oct 23, 2020 |
| V1.0.8  | <ol style="list-style-type: none"> <li>Added HR3280-BT-HC picture in the first page.</li> <li>Added Cleaning and Disinfecting Guidelines for HR3280-BT-HC in Chapter 1.</li> </ol>  | Nov 23, 2020 |
| V1.0.9  | <ol style="list-style-type: none"> <li>Added Do Not Disturb Mode for HR3280-BT-HC in Chapter 3</li> </ol> <p>Note: Firmware version HR32-BT_V1.01.021 or later is required for the new feature above.</p>   | Jan 19, 2021 |

# Table of Contents

|   |           |
|---|-----------|
| <b>Revision History .....</b>                               | <b>3</b>  |
| <b>Preface .....</b>  | <b>1</b>  |
| Introduction .....  | 1         |
| Chapter Description .....                                   | 1         |
| Explanation of Icons .....                                  | 2         |
| <b>Chapter 1 Getting Started .....</b>                      | <b>3</b>  |
| Introduction .....  | 3         |
| Features of the HR3280 .....                                | 3         |
| Unpacking .....   | 3         |
| The Scanner.....  | 4         |
| Dimensions of the Scanner (unit: mm).....                   | 5         |
| CD32 Cradle .....   | 6         |
| Dimensions of the Cradle (unit: mm).....                    | 7         |
| Connecting the Cradle to a Host.....                        | 8         |
| Using USB Cable .....                                       | 8         |
| Using RS-232 Cable .....                                    | 9         |
| Charging the Scanner Battery .....                          | 9         |
| Pairing the Scanner to a Cradle .....                       | 10        |
| Searching Paired Scanner(s) .....                           | 10        |
| Wireless Communications.....                                | 10        |
| Power On, Power Off, Reboot.....                            | 11        |
| Cleaning and Disinfecting Guidelines for HR3280-BT-HC ..... | 12        |
| <b>Chapter 2 Easyset .....</b>                              | <b>14</b> |
| <b>Chapter 3 System Setting .....</b>                       | <b>15</b> |
| Introduction .....  | 15        |
| Barcode Programming .....                                   | 15        |
| Command Programming.....                                    | 15        |
| EasySet Programming .....                                   | 15        |
| Programming Barcode/ Programming Command/Function .....     | 16        |
| Use of Programming Command.....                             | 17        |
| Use of Programming Barcodes .....                           | 17        |
| Illumination .....  | 18        |
| Illumination Color .....                                    | 18        |

|  |    |
|--|----|
| Aiming .....                                     | 19 |
| Good Read LED .....                              | 20 |
| Good Read LED Duration .....                     | 20 |
| Power On Beep .....                              | 21 |
| Good Read Beep .....                             | 21 |
| Good Read Beep Duration .....                    | 22 |
| Good Read Beep Frequency .....                   | 23 |
| Good Read Beep Volume .....                      | 24 |
| Reminder Beep Volume .....                       | 25 |
| Do Not Disturb Mode (for HR3280-BT-HC) .....     | 27 |
| Turn On/Off Do Not Disturb Mode by Trigger ..... | 27 |
| Scan Mode .....                                  | 28 |
| Decode Session Timeout .....                     | 29 |
| Image Stabilization Timeout (Sense Mode) .....   | 30 |
| Reread Timeout .....                             | 31 |
| Image Decoding Timeout .....                     | 32 |
| Image Decoding Preference .....                  | 33 |
| Sensitivity (Sense Mode) .....                   | 33 |
| Scanning Preference .....                        | 34 |
| Read Barcode On/Off .....                        | 34 |
| Smart Stand Mode .....                           | 35 |
| Decode Area .....                                | 35 |
| Image Flipping .....                             | 39 |
| Bad Read Message .....                           | 40 |
| Set Bad Read Message .....                       | 40 |
| Power Off/Battery Off .....                      | 41 |
| Default Settings .....                           | 41 |
| Factory Defaults .....                           | 41 |
| Custom Defaults .....                            | 41 |
| Query Scanner Information .....                  | 43 |
| Query Product Name .....                         | 43 |
| Query Decoder Version .....                      | 43 |
| Query Bluetooth Hardware Version .....           | 44 |
| Query Data Formatter Version .....               | 44 |
| Query Hardware Version .....                     | 44 |
| Query Serial Number .....                        | 44 |
| Query Manufacturing Date .....                   | 44 |

|  |           |
|--|-----------|
| Query OEM Serial Number .....                      | 46        |
| Query Cradle Information .....                     | 46        |
| Query Model Number .....                           | 46        |
| Query Firmware Version .....                       | 46        |
| Query Hardware Information .....                   | 47        |
| Query Cradle Bluetooth Hardware Version .....      | 47        |
| Query Serial Number .....                          | 47        |
| Query OEM Serial Number (ESN) .....                | 47        |
| Query Manufacturing Date .....                     | 48        |
| Query Remaining Battery of Scanner .....           | 49        |
| <b>Chapter 4 RS-232 Interface .....</b>            | <b>50</b> |
| Introduction .....                                 | 50        |
| Datalogic Magellan Aux-RS232 .....                 | 50        |
| Baud Rate .....                                    | 50        |
| Parity Check .....                                 | 51        |
| Data Bit .....                                     | 53        |
| Stop Bit .....                                     | 53        |
| Hardware Auto Flow Control .....                   | 54        |
| <b>Chapter 5 USB Interface .....</b>               | <b>55</b> |
| Introduction .....                                 | 55        |
| USB HID Keyboard .....                             | 56        |
| USB Country Keyboard Types .....                   | 57        |
| Emulate ALT+Keypad .....                           | 61        |
| Function Key Mapping .....                         | 65        |
| ASCII Function Key Mapping Table .....             | 66        |
| ASCII Function Key Mapping Table (Continued) ..... | 67        |
| Inter-Keystroke Delay .....                        | 68        |
| Caps Lock .....                                    | 69        |
| Convert Case .....                                 | 70        |
| Emulate Numeric Keypad .....                       | 71        |
| Polling Rate .....                                 | 73        |
| USB CDC .....                                      | 75        |
| HID POS (POS HID Barcode Scanner) .....            | 76        |
| Introduction .....                                 | 76        |
| Access the Cradle with Your Program .....          | 76        |
| Acquire Scanned Data .....                         | 77        |
| Send Command to the Cradle .....                   | 77        |

|  |           |
|--|-----------|
| VID/PID .....  | 78        |
| <b>Chapter 6 Wireless Communication .....</b>                      | <b>79</b> |
| Default Setting of Wireless Communication .....                    | 79        |
| Clear Pairing Information of Cradle .....                          | 79        |
| Operating Modes.....   | 80        |
| Batch Mode.....  | 81        |
| Batch Mode Options .....   | 81        |
| Prevent Same Barcode Storage .....                                 | 81        |
| Batch Mode Transmit Delay.....                                     | 83        |
| End of Transmission Message for Batch Mode.....                    | 84        |
| Transmit Stored Data.....  | 85        |
| Auto Clear Stored Data after Transmission.....                     | 85        |
| Query/Clear Stored Data in Flash .....                             | 85        |
| Retransmission .....   | 86        |
| Scanner(s) to Cradle Support.....                                  | 87        |
| Wireless Communication Modes.....                                  | 87        |
| Clear Pairing Info on Scanner/Cradle .....                         | 87        |
| Auto Power-Off Timeout.....  | 88        |
| Set Scanner Name .....   | 89        |
| Set Date and Time .....  | 90        |
| Query Current Date and Time .....                                  | 90        |
| Time Stamp.....  | 90        |
| Set Time Stamp Format.....   | 92        |
| Host Acknowledgment .....  | 93        |
| Host Acknowledgment Timeout .....                                  | 93        |
| Host Acknowledgment Beep Volume.....                               | 94        |
| <b>Chapter 7 Symbologies.....</b>                                  | <b>95</b> |
| Introduction .....   | 95        |
| Global Settings.....   | 95        |
| Enable/Disable All Symbologies .....                               | 95        |
| Enable/Disable 1D Symbologies.....                                 | 95        |
| Enable/Disable 2D Symbologies.....                                 | 96        |
| Enable/Disable Postal Symbologies .....                            | 96        |
| Surround GS1 Application Identifiers (AI's) with Parentheses ..... | 97        |
| Transmit GS1 Check Character .....                                 | 98        |
| Code 128.....  | 99        |
| Restore Factory Defaults .....                                     | 99        |

|   |     |
|---|-----|
| Enable/Disable Code 128 .....                           | 99  |
| Set Length Range for Code 128 .....                     | 100 |
| EAN-8 .....   | 101 |
| Restore Factory Defaults .....                          | 101 |
| Enable/Disable EAN-8 .....                              | 101 |
| Transmit Check Character .....                          | 101 |
| 2-Digit Add-On Code.....                                | 102 |
| 5-Digit Add-On Code.....                                | 103 |
| Add-On Code Required.....                               | 104 |
| Convert EAN-8 to EAN-13 .....                           | 104 |
| EAN-13 .....  | 105 |
| Restore Factory Defaults .....                          | 105 |
| Enable/Disable EAN-13.....                              | 105 |
| Transmit Check Character .....                          | 106 |
| 2-Digit Add-On Code.....                                | 106 |
| 5-Digit Add-On Code.....                                | 107 |
| Add-On Code Required.....                               | 107 |
| EAN-13 Beginning with 290 Add-On Code Required.....     | 108 |
| EAN-13 Beginning with 378/379 Add-On Code Required..... | 108 |
| EAN-13 Beginning with 414/419 Add-On Code Required..... | 109 |
| EAN-13 Beginning with 434/439 Add-On Code Required..... | 109 |
| EAN-13 Beginning with 977 Add-On Code Required.....     | 111 |
| EAN-13 Beginning with 978 Add-On Code Required.....     | 111 |
| EAN-13 Beginning with 979 Add-On Code Required.....     | 112 |
| UPC-E.....  | 113 |
| Restore Factory Defaults .....                          | 113 |
| Enable/Disable UPC-E.....                               | 113 |
| Transmit Check Character .....                          | 114 |
| 2-Digit Add-On Code.....                                | 114 |
| 5-Digit Add-On Code.....                                | 115 |
| Add-On Code Required.....                               | 116 |
| Transmit Preamble Character .....                       | 116 |
| Convert UPC-E to UPC-A .....                            | 116 |
| UPC-A.....  | 118 |
| Restore Factory Defaults .....                          | 118 |
| Enable/Disable UPC-A.....                               | 118 |
| Transmit Check Character .....                          | 118 |



|  |     |
|--|-----|
| 2-Digit Add-On Code.....                           | 119 |
| 5-Digit Add-On Code.....                           | 120 |
| Add-On Code Required.....                          | 121 |
| Transmit Preamble Character.....                   | 121 |
| Coupon .....                                       | 122 |
| UPC-A/EAN-13 with Extended Coupon Code.....        | 122 |
| Coupon GS1 Databar Output.....                     | 123 |
| Interleaved 2 of 5 .....                           | 124 |
| Restore Factory Defaults .....                     | 124 |
| Enable/Disable Interleaved 2 of 5 .....            | 124 |
| Set Length Range for Interleaved 2 of 5 .....      | 125 |
| Check Character Verification .....                 | 126 |
| Febraban.....                                      | 127 |
| Disable/Enable Febraban.....                       | 127 |
| Transmit Delay per Character .....                 | 127 |
| Transmit Delay per 12 Characters .....             | 130 |
| ITF-14 .....                                       | 132 |
| Restore Factory Defaults .....                     | 132 |
| Enable/Disable ITF-14 .....                        | 132 |
| ITF-6 .....  | 133 |
| Restore Factory Defaults .....                     | 133 |
| Enable/Disable ITF-6 .....                         | 133 |
| Matrix 2 of 5 .....                                | 134 |
| Restore Factory Defaults .....                     | 134 |
| Enable/Disable Matrix 2 of 5 .....                 | 134 |
| Set Length Range for Matrix 2 of 5 .....           | 135 |
| Check Character Verification .....                 | 136 |
| Code 39 .....                                      | 137 |
| Restore Factory Defaults .....                     | 137 |
| Enable/Disable Code 39 .....                       | 137 |
| Set Length Range for Code 39 .....                 | 138 |
| Check Character Verification .....                 | 139 |
| Transmit Start/Stop Character .....                | 140 |
| Enable/Disable Code 39 Full ASCII .....            | 140 |
| Enable/Disable Code 32 (Italian Pharma Code) ..... | 141 |
| Code 32 Prefix .....                               | 141 |
| Transmit Code 32 Start/Stop Character.....         | 142 |

|  |     |
|--|-----|
| Transmit Code 32 Check Character .....     | 142 |
| Codabar .....                              | 143 |
| Restore Factory Defaults .....             | 143 |
| Enable/Disable Codabar .....               | 143 |
| Set Length Range for Codabar .....         | 144 |
| Check Character Verification .....         | 145 |
| Start/Stop Character .....                 | 146 |
| Code 93 .....                              | 147 |
| Restore Factory Defaults .....             | 147 |
| Enable/Disable Code 93 .....               | 147 |
| Set Length Range for Code 93 .....         | 148 |
| Check Character Verification .....         | 149 |
| China Post 25.....                         | 150 |
| Restore Factory Defaults .....             | 150 |
| Enable/Disable China Post 25 .....         | 150 |
| Set Length Range for China Post 25 .....   | 151 |
| Check Character Verification .....         | 152 |
| GS1-128 (UCC/EAN-128).....                 | 153 |
| Restore Factory Defaults .....             | 153 |
| Enable/Disable GS1-128.....                | 153 |
| Set Length Range for GS1-128.....          | 154 |
| GS1 Databar (RSS) .....                    | 155 |
| Restore Factory Defaults .....             | 155 |
| Enable/Disable GS1 Databar .....           | 155 |
| Transmit Application Identifier "01" ..... | 155 |
| GS1 Composite (EAN·UCC Composite).....     | 156 |
| Restore Factory Defaults .....             | 156 |
| Enable/Disable GS1 Composite.....          | 156 |
| Enable/Disable UPC/EAN Composite.....      | 156 |
| Code 11 .....                              | 157 |
| Restore Factory Defaults .....             | 157 |
| Enable/Disable Code 11 .....               | 157 |
| Set Length Range for Code 11 .....         | 158 |
| Check Character Verification .....         | 159 |
| Transmit Check Character .....             | 160 |
| ISBN.....                                  | 161 |
| Restore Factory Defaults .....             | 161 |

|  |     |
|--|-----|
| Enable/Disable ISBN.....                 | 161 |
| Set ISBN Format.....                     | 162 |
| ISSN.....                                | 163 |
| Restore Factory Defaults .....           | 163 |
| Enable/Disable ISSN.....                 | 163 |
| Industrial 25.....                       | 164 |
| Restore Factory Defaults .....           | 164 |
| Enable/Disable Industrial 25 .....       | 164 |
| Set Length Range for Industrial 25 ..... | 165 |
| Check Character Verification .....       | 166 |
| Standard 25.....                         | 167 |
| Restore Factory Defaults .....           | 167 |
| Enable/Disable Standard 25 .....         | 167 |
| Set Length Range for Standard 25 .....   | 168 |
| Check Character Verification .....       | 169 |
| Plessey .....                            | 170 |
| Restore Factory Defaults .....           | 170 |
| Enable/Disable Plessey .....             | 170 |
| Set Length Range for Plessey .....       | 171 |
| Check Character Verification .....       | 172 |
| MSI-Plessey.....                         | 173 |
| Restore Factory Defaults .....           | 173 |
| Enable/Disable MSI-Plessey.....          | 173 |
| Set Length Range for MSI-Plessey.....    | 174 |
| Check Character Verification .....       | 175 |
| Transmit Check Character .....           | 176 |
| AIM 128.....                             | 177 |
| Restore Factory Defaults .....           | 177 |
| Enable/Disable AIM 128.....              | 177 |
| Set Length Range for AIM 128.....        | 178 |
| ISBT 128 .....                           | 179 |
| Restore Factory Defaults .....           | 179 |
| Enable/Disable ISBT 128.....             | 179 |
| Code 49 .....                            | 180 |
| Restore Factory Defaults .....           | 180 |
| Enable/Disable Code 49 .....             | 180 |
| Set Length Range for Code 49 .....       | 181 |

|   |     |
|---|-----|
| Code 16K .....                          | 182 |
| Restore Factory Defaults .....          | 182 |
| Enable/Disable Code 16K .....           | 182 |
| Set Length Range for Code 16K .....     | 183 |
| PDF417 .....                            | 184 |
| Restore Factory Defaults .....          | 184 |
| Enable/Disable PDF417 .....             | 184 |
| Set Length Range for PDF417 .....       | 185 |
| PDF417 Twin Code .....                  | 186 |
| PDF417 Inverse .....                    | 187 |
| Character Encoding .....                | 187 |
| PDF417 ECI Output .....                 | 188 |
| Micro PDF417 .....                      | 189 |
| Restore Factory Defaults .....          | 189 |
| Enable/Disable Micro PDF417 .....       | 189 |
| Set Length Range for Micro PDF417 ..... | 190 |
| QR Code .....                           | 191 |
| Restore Factory Defaults .....          | 191 |
| Enable/Disable QR Code .....            | 191 |
| Set Length Range for QR Code .....      | 192 |
| QR Twin Code .....                      | 193 |
| QR Inverse .....                        | 194 |
| Character Encoding .....                | 194 |
| QR ECI Output .....                     | 195 |
| Micro QR Code .....                     | 196 |
| Restore Factory Defaults .....          | 196 |
| Enable/Disable Micro QR .....           | 196 |
| Set Length Range for Micro QR .....     | 197 |
| Aztec .....                             | 198 |
| Restore Factory Defaults .....          | 198 |
| Enable/Disable Aztec Code .....         | 198 |
| Set Length Range for Aztec Code .....   | 199 |
| Read Multi-barcodes on an Image .....   | 200 |
| Set the Number of Barcodes .....        | 201 |
| Character Encoding .....                | 202 |
| Aztec ECI Output .....                  | 202 |
| Data Matrix .....                       | 203 |

|   |     |
|---|-----|
| Restore Factory Defaults .....                  | 203 |
| Enable/Disable Data Matrix.....                 | 203 |
| Set Length Range for Data Matrix.....           | 204 |
| Data Matrix Twin Code.....                      | 205 |
| Rectangular Barcode .....                       | 206 |
| Data Matrix Inverse.....                        | 206 |
| Character Encoding .....                        | 207 |
| Data Matrix ECI Output.....                     | 207 |
| Maxicode.....                                   | 208 |
| Restore Factory Defaults .....                  | 208 |
| Enable/Disable Maxicode.....                    | 208 |
| Set Length Range for Maxicode.....              | 209 |
| Chinese Sensible Code.....                      | 210 |
| Restore Factory Defaults .....                  | 210 |
| Enable/Disable Chinese Sensible Code.....       | 210 |
| Set Length Range for Chinese Sensible Code..... | 211 |
| Chinese Sensible Twin Code .....                | 212 |
| Chinese Sensible Code Inverse.....              | 213 |
| GM Code.....                                    | 214 |
| Restore Factory Defaults .....                  | 214 |
| Enable/Disable GM .....                         | 214 |
| Set Length Range for GM .....                   | 215 |
| Code One.....                                   | 216 |
| Restore Factory Defaults .....                  | 216 |
| Enable/Disable Code One.....                    | 216 |
| Set Length Range for Code One.....              | 217 |
| USPS Postnet .....                              | 218 |
| Restore Factory Defaults .....                  | 218 |
| Enable/Disable USPS Postnet.....                | 218 |
| Transmit Check Character .....                  | 218 |
| USPS Intelligent Mail .....                     | 219 |
| Restore Factory Defaults .....                  | 219 |
| Enable/Disable USPS Intelligent Mail .....      | 219 |
| Royal Mail .....                                | 220 |
| Restore Factory Defaults .....                  | 220 |
| Enable/Disable Royal Mail .....                 | 220 |
| USPS Planet .....                               | 221 |

|  |            |
|--|------------|
| Restore Factory Defaults .....             | 221        |
| Enable/Disable USPS Planet .....           | 221        |
| Transmit Check Character .....             | 221        |
| KIX Post .....                             | 222        |
| Restore Factory Defaults .....             | 222        |
| Enable/Disable KIX Post .....              | 222        |
| Australian Postal .....                    | 223        |
| Restore Factory Defaults .....             | 223        |
| Enable/Disable Australian Postal .....     | 223        |
| Passport OCR .....                         | 224        |
| Restore Factory Defaults .....             | 224        |
| Enable/Disable Passport OCR .....          | 224        |
| <b>Chapter 8 Data Formatter .....</b>      | <b>225</b> |
| Introduction .....                         | 225        |
| Add a Data Format .....                    | 225        |
| Programming with Barcodes .....            | 225        |
| Programming with Serial Commands .....     | 228        |
| Enable/Disable Data Formatter .....        | 229        |
| Non-Match Error Beep .....                 | 230        |
| Data Format Selection .....                | 231        |
| Change Data Format for a Single Scan ..... | 232        |
| Clear Data Format .....                    | 233        |
| Query Data Formats .....                   | 233        |
| Formatter Command Type 6 .....             | 234        |
| Send Commands .....                        | 234        |
| Move Commands .....                        | 238        |
| Search Commands .....                      | 240        |
| Comparison Command .....                   | 243        |
| Miscellaneous Commands .....               | 245        |
| <b>Chapter 9 Prefix&amp;Suffix .....</b>   | <b>251</b> |
| Introduction .....                         | 251        |
| Global Settings .....                      | 252        |
| Enable/Disable All Prefixes/Suffixes ..... | 252        |
| Prefix Sequence .....                      | 252        |
| Custom Prefix .....                        | 253        |
| Enable/Disable Custom Prefix .....         | 253        |
| Set Custom Prefix .....                    | 253        |

|   |            |
|---|------------|
| AIM ID Prefix .....                               | 254        |
| Code ID Prefix .....                              | 255        |
| Restore All Default Code IDs .....                | 255        |
| Modify Code ID .....                              | 255        |
| Custom Suffix .....                               | 252        |
| Enable/Disable Custom Suffix .....                | 252        |
| Set Custom Suffix .....                           | 252        |
| Data Packing .....                                | 253        |
| Introduction .....                                | 253        |
| Data Packing Options .....                        | 253        |
| Terminating Character Suffix .....                | 255        |
| Enable/Disable Terminating Character Suffix ..... | 255        |
| Set Terminating Character Suffix .....            | 255        |
| <b>Chapter 10 Batch Programming .....</b>         | <b>257</b> |
| Introduction .....                                | 257        |
| Create a Batch Command .....                      | 258        |
| Create a Batch Barcode .....                      | 258        |
| Use Batch Barcode .....                           | 259        |
| <b>Appendix .....</b>                             | <b>260</b> |
| Digit Barcodes .....                              | 260        |
| Save/Cancel Barcodes .....                        | 263        |
| Factory Defaults Table .....                      | 264        |
| AIM ID Table .....                                | 274        |
| Code ID Table .....                               | 275        |
| Symbology ID Number .....                         | 277        |
| ASCII Table .....                                 | 279        |
| Unicode Key Maps .....                            | 283        |





# Preface

## Introduction

This manual provides detailed instructions for setting up and using the NLS-HR3280-BT/HR3280-BT-HC wireless 2D barcode scanner (hereinafter referred to as “**the HR3280**” or “**the scanner**”).

## Chapter Description

|  |   |
|--|---|
| <i>Chapter 1 Getting Started</i>         | : Gives a general description of HR3280 scanner   |
| <i>Chapter 2 EasySet</i>                 | : Introduces a useful tool you can use to set up HR3280 scanner and develop new applications.                                 |
| <i>Chapter 3 System Settings</i>         | : Introduces three configuration methods and describes how to configure general parameters of HR3280 scanner.                 |
| <i>Chapter 4 RS-232 Interface</i>        | : Describes how to configure RS-232 communication parameters.   |
| <i>Chapter 5 USB Interface</i>           | : Describes how to configure USB communication parameters.  |
| <i>Chapter 6 Wireless Communications</i> | : Describes how to configure the parameters necessary for wireless communication between the scanner, cradle and host device. |
| <i>Chapter 7 Symbologies</i>             | : Lists all compatible symbologies and describes how to configure the relevant parameters.                                    |
| <i>Chapter 8 Data Formatter</i>          | : Explains how to customize scanned data with the data formatter.   |
| <i>Chapter 9 Prefix &amp; Suffix</i>     | : Describes how to use prefix and suffix to customize scanned data.   |
| <i>Chapter 10 Batch Programming</i>      | : Explains how to integrate a complex programming task into a single barcode.   |
| <i>Appendix</i>                          | : Provides factory defaults table and a bunch of frequently used programming barcodes.  |

---

## Explanation of Icons



This icon indicates something relevant to this manual.



This icon indicates this information requires extra attention from the reader.



This icon indicates handy tips that can help you use or configure the scanner with ease.



This icon indicates practical examples that can help you to acquaint yourself with opera

# Chapter 1 Getting Started

## Introduction

The HR3280 wireless 2D barcode scanner reads a 1D or 2D barcode by capturing its image. Adopting the advanced **UIMG** technology independently developed by Newland Auto-ID Tech, it provides five scan modes, including Level mode, Sense mode, Continuous mode, Pulse mode and Batch mode, tailored to different scanning needs.

An illustrated introduction to the HR3280 is included in this chapter. If you have an HR3280 scanner at hand, make good use of it to develop a better understanding of this manual. This chapter is written for normal users, maintenance staff and software developers.

## Features of the HR3280

- ★ More reliable, more versatile, more efficient scanning solution
- ★ Bluetooth 5.0 radio
- ★ User-friendly illumination & aiming
- ★ Ultra-rugged construction
- ★ Flexible mounting of cradle

## Unpacking

Open the package and take out HR3280 scanner and its accessories. Check to make sure everything on the packing list is present and intact. If any contents are damaged or missing, please keep the original package and contact your dealer immediately for after-sales service.

---

## The Scanner

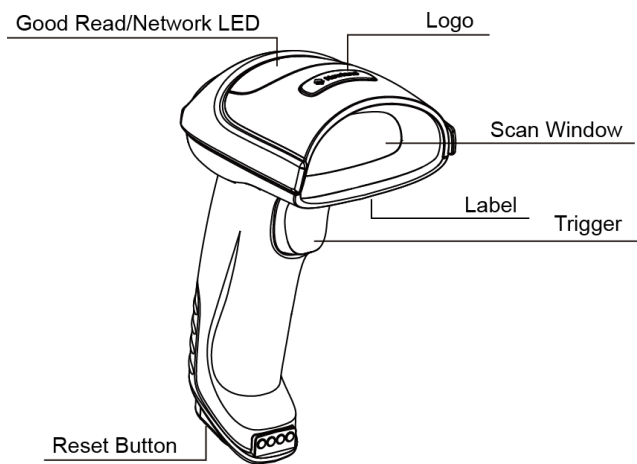

### **Good Read/Network LED:**

Red LED flashes - Low battery alert.

Red LED on - Scanner not paired to cradle.

Blue LED flashes slowly - Paired but no connection established.

Blue LED on - Connection established.

Blue LED flashes quickly - Batch transmission in progress.

Green LED flashes once - Good read.

Dimensions of the Scanner (unit: mm)

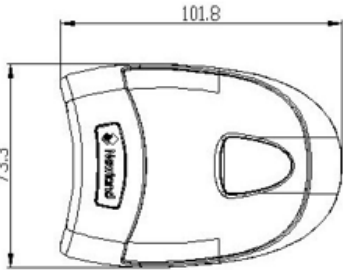
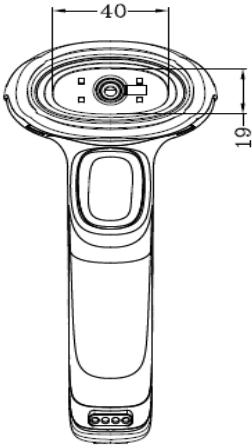
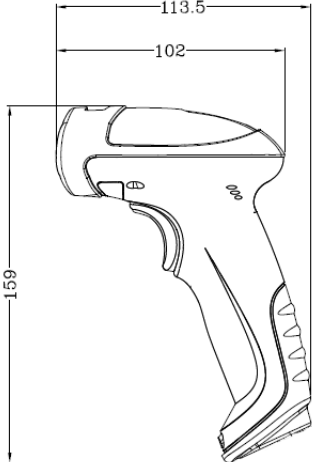

## CD32 Cradle

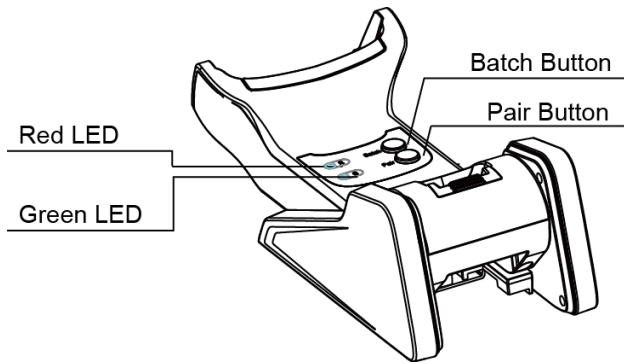

### Red/Green LEDs:

Red LED on - No scanner placed on cradle.

Red LED flashes - Charging in progress, low battery level.

Green LED flashes - Charging in progress, medium battery level.

Green LED on - Fully charged.

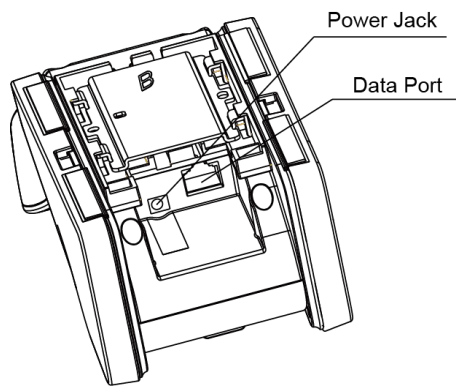

### Data Port Pinouts:

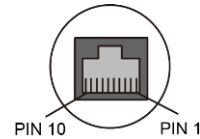

| PIN | Signal | Type | Function            |
|-----|--------|------|---------------------|
| 1   | NC     | -    | No connection       |
| 2   | NC     | -    | No connection       |
| 3   | VCC    | P    | Power+ (+5V)        |
| 4   | TXD    | O    | RS-232 output       |
| 5   | RXD    | I    | RS-232 input        |
| 6   | CTS    | I    | Flow control signal |
| 7   | RTS    | O    |                     |
| 8   | GND    | P    | Ground              |
| 9   | D-     | I/O  | USB signal          |
| 10  | D+     | I/O  |                     |

Dimensions of the Cradle (unit: mm)

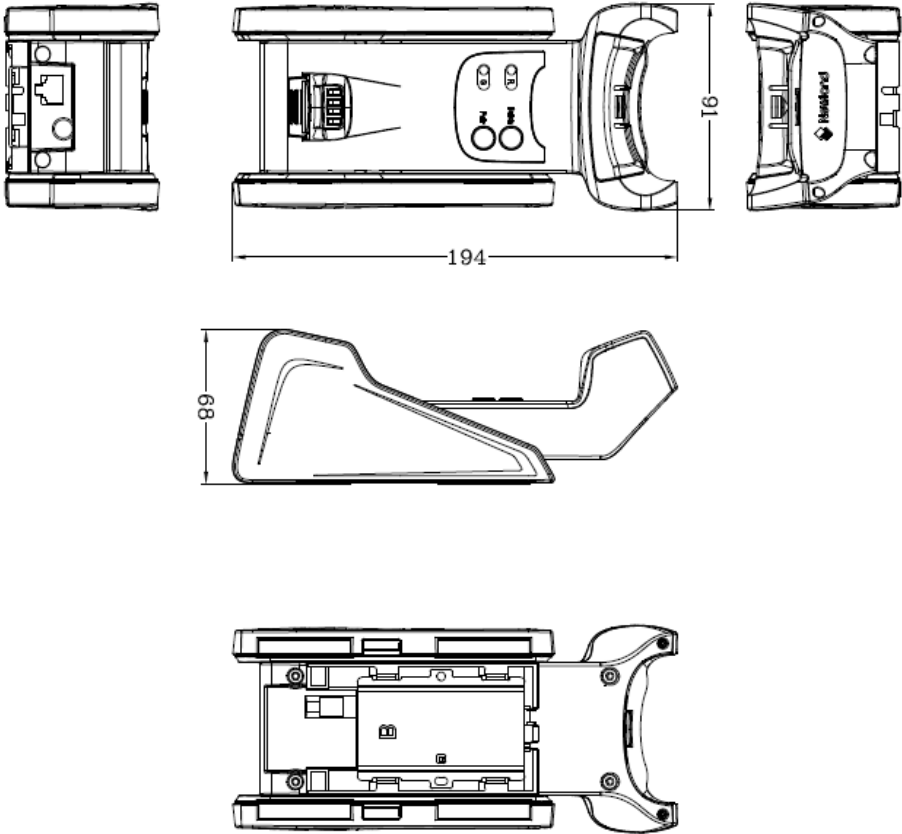

---

## Connecting the Cradle to a Host

The cradle can be connected to a host in actual application, such as PC, POS or any intelligent terminal with USB or RS-232 port, using a communication cable (USB or RS-232 cable).

### USB



### RS-232



**Note:** Please check the port on the host and purchase the cable accordingly.

## Using USB Cable

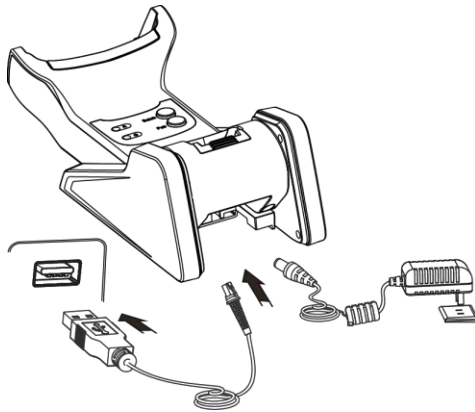

Connect the cradle to a Host using a USB cable with RJ45 and USB connectors:

1. Plug the RJ45 connector of the cable into the data port on the cradle.
  2. Plug the USB connector of the cable into the USB port on the Host.
  3. Plug the supplied power adapter into the power jack on the cradle.
-



## Using RS-232 Cable

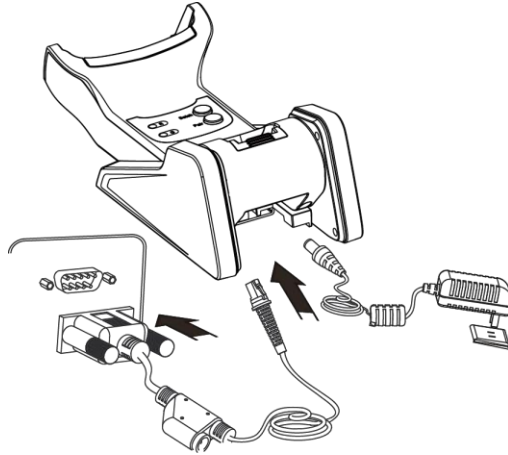

Connect the cradle to a Host using an RS-232 cable with RJ45 and RS-232 connectors:

1. Plug the RJ45 connector of the cable into the data port on the cradle.
2. Plug the RS-232 connector of the cable into the RS-232 port on the Host.
3. Plug the supplied power adapter into the power jack on the cradle.

## Charging the Scanner Battery

To charge the scanner battery, insert the scanner in a powered cradle. You can check the charge status with the red and green LEDs on the cradle.

|                     |  |
|---------------------|--|
| Red LED steady on   | No scanner placed on cradle                |
| Red LED flashes     | Charging in progress, low battery level    |
| Green LED flashes   | Charging in progress, medium battery level |
| Green LED steady on | Fully charged                              |

---

## Pairing the Scanner to a Cradle

Before configuring or using the scanner, you must pair it to a cradle first. A cradle can pair with up to seven scanners if **Multi-Point-to-Single Point** mode is enabled.

You need to perform the pairing operation manually: After the scanner and cradle are turned on, insert the scanner in the cradle and then press the Pair button on the cradle. The scanner beeps on a successful pairing.

To unpair them, you may pair the scanner to another cradle, or scan the **Clear Pairing Info on Cradle** or **Clear Pairing Info on Scanner** barcode in Chapter 4.

## Searching Paired Scanner(s)

After the scanner(s) and cradle are turned on, press the Pair button on the cradle and the paired scanner(s) will beep.

## Wireless Communications

The scanner can communicate with a remote host by pairing with a CD32 cradle that supports the following interfaces:

- ✧ Standard RS-232 connection to a host. For the cable connection instructions, see the “Using RS-232 Cable” section in this chapter. To learn how to configure RS-232 communication parameters, see Chapter 4.
- ✧ USB connection to a host. For the cable connection instructions, see the “Using USB Cable” section in this chapter. To learn how to configure USB communication parameters, see Chapter 5.

For wireless communication parameters, see Chapter 6.

## Power On, Power Off, Reboot

### Power on the scanner

Hold down the trigger on the scanner until it beeps.

Note: When using the scanner for the first time or after scanning the **Battery Off** barcode in Chapter 3, you MUST insert the scanner in a powered cradle to exit battery protection mode before turning it on.

### Power off the scanner

**Method 1:** When in the Level scan mode, the scanner will automatically power off after a specific period of inactivity (default: 5 minutes, programmable). To change the period, see the “Auto Power-Off Timeout” section in Chapter 3.

**Method 2:** Scan the **Power Off Scanner** barcode in Chapter 3.

### Reboot the scanner

If the scanner stops responding to input or runs abnormally, press and hold the Reset button on the bottom of the scanner with a straightened paperclip to reboot it.

---

## Cleaning and Disinfecting Guidelines for HR3280-BT-HC

- ❖ The scan window should be kept clean.
- ❖ Do not scratch the scan window.
- ❖ Use soft brush to remove the stain from the scan window.
- ❖ Use the soft cloth to clean the window, such as eyeglass cleaning cloth.
- ❖ Do not spray any liquid on the scan window.
- ❖ The below detergents can be used to sanitize and clean the scanner
  - Water
  - 3% Hydrogen Peroxide and 97% Water solution
  - 91% Isopropyl Alcohol and 9% Water Solution
  - Metrex CaviCide
  - 75% Alcohol
  - Clinell Universal Sanitising Wipes
  - Sani-Hands® Instant Hand Sanitizing Wipes
  - PDI Sani-Cloth AF3 Germicidal Disposable Wipe
  - 10% Bleach (Sodium Hypochlorite 0.55%) and 90% Water Solution (*Do not apply it on the label of the scanner*)
  - Do not apply any detergents in USB port



The warranty **DOES NOT** cover damages caused by inappropriate care and maintenance.  
Do not tear the label protective film.

## Scanning Instructions

When the scanner is in the Level scan mode, you can follow the steps below to scan a barcode:

1. Press and hold the Trigger. Then the scanner will project a red aiming pattern.
2. Aim the aiming pattern across the center of barcode.
3. Release the Trigger when the aiming pattern goes off. If the barcode is decoded successfully, the scanner will emit a good read beep and the decoded data will be sent to the Host.

**Note:** For barcodes of the same batch, the scanner keeps a very high success ratio in certain distance which is regarded as the optimal scanning distance.

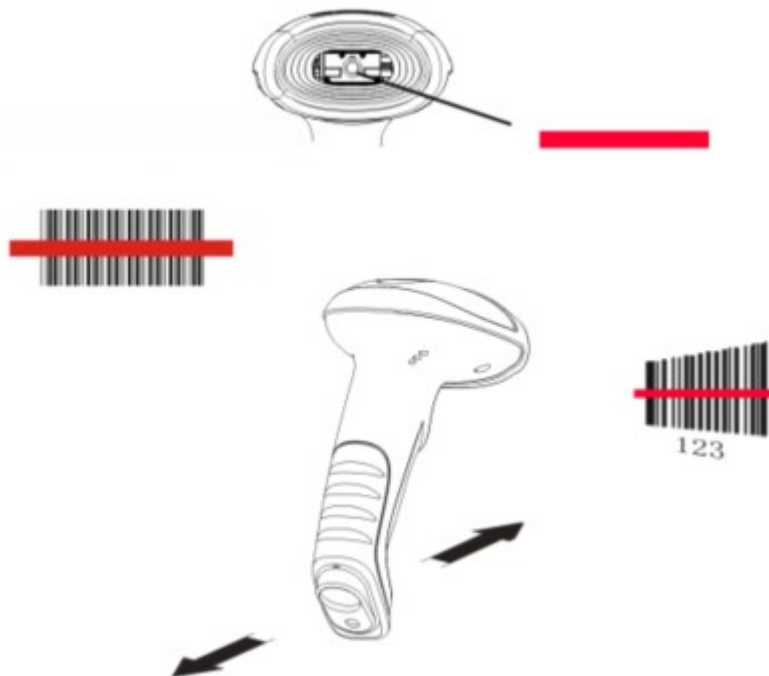

## Chapter 2 Easyset

EasySet, developed by Fujian Newland Auto-ID Tech. Co., Ltd., is a configuration tool for Newland's 1D/2D handheld barcode scanner, fixed mount barcode scanners and OEM scan engines. Its main features include:

- ✧ View device & configuration information of online device
- ✧ Configure device
- ✧ Update firmware of online device
- ✧ Load/modify existing XML configuration file; save current settings to an XML file
- ✧ Create/print/save programming barcodes to a PDF or Word file
- ✧ View/edit/save image stored on online device in the original image/BMP/JPG/TIFF format
- ✧ Send serial commands to online device and receive device response
- ✧ Supported languages: Chinese and English.

EasySet supports 32-bit/64-bit Microsoft WinXP/Win7/Win 8/Win 8.1/Win 10 operating systems.

EasySet can communicate with device via one of the following interface: RS-232, USB COM Port Emulation (UFCOM driver required), USB CDC (UFCOM driver required), USB DataPipe (UFCOM driver required), USB HID-POS.

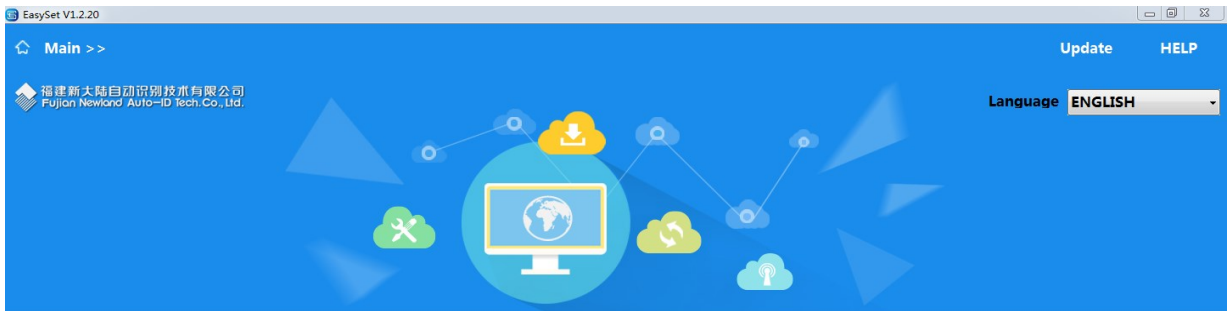



@SETUPE1

Enter Setup

## Chapter 3 System Setting

### Introduction

There are three ways to configure the HR3280: Barcode programming, command programming and Easyset programming.

#### Barcode Programming

The HR3280 can be configured by scanning programming barcodes. All user programmable features/options are described along with their programming barcodes/commands in the following sections.

This programming method is most straightforward. However, it requires manually scanning barcodes. As a result, errors are more likely to occur.

#### Command Programming

The HR3280 can also be configured by serial commands (HEX) sent from the host device.

Users can design an application program to send those command strings to the scanners to perform device configuration.

#### EasySet Programming

Besides the two methods mentioned above, you can conveniently perform scanner configuration through EasySet too. EasySet is a Windows-based configuration tool particularly designed for Newland products, enabling users to gain access to decoded data and captured images and to configure scanners. For more information about this tool, refer to the *EasySet User Guide*.



Before programming the scanner, you need to pair it to a cradle first. When programming the scanner with serial commands or EasySet, you need to insert it in the paired cradle.

Except some temporary setting will be disappeared after reboot and power off, other setting information will be stored in the scanner.



@SETUPE1

Enter Setup

---

## Programming Barcode/ Programming Command/Function



The figure above is an example that shows you the programming barcode and command for the Enter Setup function:

1. The **No Case Conversion** barcode.
2. The **No Case Conversion** command.
3. The description of feature/option.
4. \*\* indicates factory default settings.

Note: "@" included in the programming command indicates permanent setting which means the setting will not be lost by removing power from the scanner or turning off or rebooting it; whereas "#" included in the programming command indicates temporary setting which means the setting will be lost by removing power from the scanner or turning off or rebooting it.



@SETUPE0

\*\* Exit Setup





@SETUPE1  
Enter Setup

---

## Use of Programming Command

Besides the barcode programming method, the scanner can also be configured by serial commands (HEX) sent from the host device. **All commands must be entered in uppercase letters.**

## Use of Programming Barcodes

Scanning the **Enter Setup** barcode can enable the scanner to enter the setup mode. Then you can scan a number of programming barcodes to configure your scanner. To exit the setup mode, scan the **Exit Setup** barcode or a non-programming barcode, or reboot the scanner.



@SETUPE0  
**\*\* Exit Setup**



@SETUPE1  
**Enter Setup**

Programming barcode data (i.e. the characters under programming barcode) can be transmitted to the host device. You may scan the appropriate barcode below to enable or disable the transmission of programming barcode data to the host device.



#SETUPT0  
**\*\* Do Not Transmit Programming Barcode Data**



#SETUPT1  
**Transmit Programming Barcode Data**



@SETUPE0  
**\*\* Exit Setup**



@SETUPE1

**Enter Setup**

---

## Illumination



@ILLSCN1

**\*\* On**



@ILLSCN0

**Off**

## Illumination Color



@ILLCLR0

**\*\* Red LED**



@ILLCLR1

**White Led**



@ILLCLR2

**Red LED+White LED**



@SETUPE0

**\*\* Exit Setup**



@SETUPE1  
Enter Setup

---

## Aiming

When scanning/capturing image, the scanner projects an aiming pattern which allows positioning the target barcode within its field of view and thus makes decoding easier. **Normal:** The scanner projects an aiming pattern only during barcode scanning/capture.

**Always On:** Aiming pattern is constantly on after the scanner is powered on.

**Off:** Aiming pattern is off all the time.



@AMLENA1  
**\*\* Normal**



@AMLENA0  
**Off**



@AMLENA2  
**Always On**



@SETUPE0  
**\*\* Exit Setup**



@SETUPE1  
**Enter Setup**

---

## Good Read LED

The green LED can be programmed to be On or Off to indicate good read.



@GRLENA1  
**\*\* On**



@GRLENA0  
**Off**

## Good Read LED Duration

This parameter sets the amount of time the Good Read LED remains on following a good read.



@GRLDUR20  
**\*\* Short (20ms)**



@GRLDUR120  
**Medium (120ms)**



@GRLDUR220  
**Long (220ms)**



@GRLDUR320  
**Prolonged (320ms)**



@GRLDUR  
**Custom (1 - 2,500ms)**



@SETUPE0  
**\*\* Exit Setup**



@SETUPE1  
Enter Setup

---

## Example

### Set the Good Read LED duration to 800ms:

1. Scan the **Enter Setup** barcode.
2. Scan the **Custom** barcode.
3. Scan the numeric barcodes “8”, “0” and “0” from the “Digit Barcodes” section in Appendix.
4. Scan the **Save** barcode from the “Save/Cancel Barcodes” section in Appendix.
5. Scan the **Exit Setup** barcode.

## Power On Beep

The scanner can be programmed to beep when it is powered on. Scan the **Off** barcode if you do not want a power on beep.



@PWBENA1  
\*\* On



@PWBENA0  
Off

## Good Read Beep

Scanning the **Off** barcode can turn off the beep that indicates successful decode; scanning the **On** barcode can turn it back on.



@GRBENA1  
\*\* On



@GRBENA0  
Off



@SETUPE0  
\*\* Exit Setup



@SETUPE1

**Enter Setup**

---

## Good Read Beep Duration

This parameter sets the length of the beep the scanner emits on a good read. It is programmable in 1ms increments from 20ms to 300ms.



@GRBDUR40

**Short (40ms)**



@GRBDUR80

**\*\* Medium (80ms)**



@GRBDUR120

**Long (120ms)**



@GRBDUR

**Custom (20 – 300ms)**

**E**  
*example*

**Set the Good Read Beep duration to 200ms:**

1. Scan the **Enter Setup** barcode.
2. Scan the **Custom** barcode.
3. Scan the numeric barcodes “2”, “0” and “0” from the “Digit Barcodes” section in Appendix.
4. Scan the **Save** barcode from the “Save/Cancel Barcodes” section in Appendix.
5. Scan the **Exit Setup** barcode.



@SETUPE0

**\*\* Exit Setup**



@SETUPE1  
Enter Setup

## Good Read Beep Frequency

This parameter is programmable in 1Hz increments from 20Hz to 20,000Hz.



@GRBFRQ800  
Extra Low (800Hz)



@GRBFRQ1600  
Low (1600Hz)



@GRBFRQ2730  
\*\* Medium (2730Hz)



@GRBFRQ4200  
High (4200Hz)



@GRBFRQ  
Custom (20 - 20,000Hz)

**E**  
*sample*

### Set the Good Read Beep frequency to 2,000Hz:

1. Scan the **Enter Setup** barcode.
2. Scan the **Custom** barcode.
3. Scan the numeric barcodes “2”, “0”, “0” and “0” from the “Digit Barcodes” section in Appendix.
4. Scan the **Save** barcode from the “Save/Cancel Barcodes” section in Appendix.
5. Scan the **Exit Setup** barcode.



@SETUPE0  
\*\* Exit Setup



@SETUPE1

**Enter Setup**

---

## Good Read Beep Volume



@GRBVOL0

**\*\* Loud**



@GRBVOL1

**Medium**



@GRBVOL2

**Low**



@GRBVLL

**Custom (1-20)**

**E**  
*example*

### Set the Good Read Beep Volume to 20

1. Scan the **Enter Setup** barcode.
2. Scan the **Custom** barcode.
3. Scan the numeric barcodes “2”, “0” from the “Digit Barcodes” section in Appendix.
4. Scan the **Save** barcode from the “Save/Cancel Barcodes” section in Appendix.
5. Scan the **Exit Setup** barcode.



@SETUPE0

**\*\* Exit Setup**





@SETUPE1  
Enter Setup

---

## Reminder Beep Volume

This parameter is available for reminder beep volume of the following operations: power on (for all products), power off, batch transmission, pairing the scanner to a cradle, searching paired scanner, the scanner connects on the cradle, the scanner disconnects the cradle, bluetooth connection and transmission.



@SUCVLL20  
\*\* Loud



@SUCVLL5  
Low



@SUCVLL  
Custom (0-20)



@SUCVLL12  
Medium



@SUCVLL0  
Mute

**E**  
*sample*

Set the above operations' beep volume to 10:

1. Scan the **Enter Setup** barcode.
2. Scan the **Beep Volume** barcode.
3. Scan the numeric barcodes "1", "0" and "0" from the "Digit Barcodes" section in Appendix.
4. Scan the **Save** barcode from the "Save/Cancel Barcodes" section in Appendix.
5. Scan the **Exit Setup** barcode.



@SETUPE0  
\*\* Exit Setup



@SETUPE1

**Enter Setup**

This parameter is available for setting beep volume of the following operations: beep on unknown (USB KBW), failed to batch transmission, failed to search paired scanner, bluetooth disconnection and bluetooth transmission failure.



@ALMVLL20

**\*\* Loud**



@ALMVLL12

**Medium**



@ALMVLL5

**Low**



@ALMVLL0

**Mute**



@ALMVLL

**Cutomer(0-20)**

**E**  
*sample*

**Set the above operations' beep volume to 10:**

1. Scan the **Enter Setup** barcode.
2. Scan the **Beep Volume** barcode.
3. Scan the numeric barcodes "1", "0" and "0" from the "Digit Barcodes" section in Appendix.
4. Scan the **Save** barcode from the "Save/Cancel Barcodes" section in Appendix.
5. Scan the **Exit Setup** barcode.



@SETUPE0

**\*\* Exit Setup**



@SETUPE1  
Enter Setup

## Do Not Disturb Mode (for HR3280-BT-HC)

The Do Not Disturb mode is a mode specially designed for medical environments. In this mode, a scanner with a vibration will disable all beep and enable vibration for good reading; a scanner without a vibration will modify the beep to 8000Hz frequency, 40ms duration, and volume 1 for good reading and disable other beep.

The scanner will beep twice when exiting this mode, and all beep will be set according to the configuration.



@HCSDND1

**Turn On Disturb Mode**



@HCSDND0

**\*\* Turn Off Do Not Disturb Mode**

## Turn On/Off Do Not Disturb Mode by Trigger

Pull the trigger 3 times quickly and do not aiming barcodes, the scanner will turn on or off the Do Not Disturb Mode



@HCSDNT1

**Turn On Disturb Mode By Trigger**



@HCSDNT0

**\*\* Turn Off Do Not Disturb Mode By Trigger**



@SETUPE0  
**\*\* Exit Setup**



@SETUPE1

Enter Setup

---

## Scan Mode

**Level Mode:** A trigger pull activates a decode session. The decode session continues until a barcode is decoded or you release the trigger.

**Sense Mode:** The scanner activates a decode session every time it detects a barcode presented to it. The decode session continues until a barcode is decoded or the decode session timeout expires. **Reread Timeout** can avoid undesired rereading of same barcode in a given period of time. **Sensitivity** can change the Sense Mode's sensibility to changes in images captured. **Image Stabilization Timeout** gives the scanner time to adapt to ambient environment after it decodes a barcode and "looks" for another.

**Continuous Mode:** The scanner automatically starts one decode session after another. To suspend/resume barcode reading, simply press the trigger. **Reread Timeout** can avoid undesired rereading of same barcode in a given period of time.

**Pulse Mode:** When the trigger is pulled and released, scanning is activated until a barcode is decoded or the decode session timeout expires (The decode session timeout begins when the trigger is released).

**Batch Mode:** A trigger pull activates a round of multiple decode sessions. This round of multiple scans continues until you release the trigger. Rereading the same barcode is not allowed in the same round.



@SCNMOD0

\*\* Level Mode



@SCNMOD2

Sense Mode



@SCNMOD3

Continuous Mode



@SCNMOD7

Batch Mode



@SCNMOD4

Pulse Mode



@SETUPE0

\*\* Exit Setup



@SETUPE1  
Enter Setup

---

## Decode Session Timeout

This parameter sets the maximum time decode session continues during a scan attempt. It is programmable in 1 ms increments from 100ms to 3,600,000ms. When it is set to 0, the timeout is infinite. The default setting is 3,000ms.



@ORTSET  
Decode Session Timeout

### **E** *Example*

#### Set the decode session timeout to 1,500ms:

1. Scan the **Enter Setup** barcode.
2. Scan the **Decode Session Timeout** barcode.
3. Scan the numeric barcodes “1”, “5”, “0” and “0” from the “Digit Barcodes” section in Appendix.
4. Scan the **Save** barcode from the “Save/Cancel Barcodes” section in Appendix.
5. Scan the **Exit Setup** barcode.



@SETUPE0  
\*\* Exit Setup



@SETUPE1

**Enter Setup**

---

## Image Stabilization Timeout (Sense Mode)

This parameter defines the amount of time the scanner will spend adapting to ambient environment after it decodes a barcode and “looks” for another. It is programmable in 1ms increments from 0ms to 3,000ms. The default setting is 200ms.



@SENIST

**Image Stabilization Timeout**

**E**  
*sample*

### Set the image stabilization timeout to 800ms:

6. Scan the **Enter Setup** barcode.
7. Scan the **Image Stabilization Timeout** barcode.
8. Scan the numeric barcodes “8”, “0” and “0” from the “Digit Barcodes” section in Appendix.
9. Scan the **Save** barcode from the “Save/Cancel Barcodes” section in Appendix.
10. Scan the **Exit Setup** barcode.



@SETUPE0

**\*\* Exit Setup**



@SETUPE1  
Enter Setup

## Reread Timeout

Reread Timeout can avoid undesired rereading of same barcode in a given period of time. This feature is only applicable to the Sense and Continuous modes.

**Enable Reread Timeout:** Do not allow the scanner to reread same barcode before the reread timeout expires.

**Disable Reread Timeout:** Allow the scanner to reread same barcode.



@RRDENA1

**Enable Reread Timeout**



@RRDENA0

**\*\* Disable Reread Timeout**

The following parameter sets the time interval between two successive reads on same barcode. It is programmable in 1ms increments from 0ms to 3,600,000ms. When it is set to a value greater than 3,000, the timeout for rereading same programming barcode is limited to 3,000ms. The default setting is 1,500ms.



@RRDDUR

**Set Reread Timeout**

**E**  
*xample*

**Set the reread timeout to 1,000ms:**

1. Scan the **Enter Setup** barcode.
2. Scan the **Set Reread Timeout** barcode.
3. Scan the numeric barcodes "1", "0", "0" and "0" from the "Digit Barcodes" section in Appendix.
4. Scan the **Save** barcode from the "Save/Cancel Barcodes" section in Appendix.
5. Scan the **Exit Setup** barcode.



@SETUPE0  
**\*\* Exit Setup**



@SETUPE1

**Enter Setup**

---

You may wish to restart the reread timeout when the scanner encounters the same barcode that was decoded in the last scan session before the reread timeout expires. To enable this feature, scan the **Reread Timeout Reset On** barcode. This feature is only effective when **Reread Timeout** is enabled.



@RRDREN1

**Reread Timeout Reset On**



@RRDREN0

**\*\* Reread Timeout Reset Off**

## Image Decoding Timeout

Image Decoding Timeout specifies the maximum time the scanner will spend decoding an image. This parameter is programmable in 1ms increments from 1ms to 3,000ms. The default timeout is 500ms.



@DETSET

**Image Decoding Timeout**

**E**  
*sample*

**Set the image decoding timeout to 1,000ms:**

1. Scan the **Enter Setup** barcode.
2. Scan the **Image Decoding Timeout** barcode.
3. Scan the numeric barcodes "1", "0", "0" and "0" from the "Digit Barcodes" section in Appendix.
4. Scan the **Save** barcode from the "Save/Cancel Barcodes" section in Appendix.
5. Scan the **Exit Setup** barcode.



@SETUPE0

**\*\* Exit Setup**





@SETUPE1  
Enter Setup

## Image Decoding Preference

When the scanner is set as **Barcodes on Screen**, decoding rate reduces obviously.



@DETPFN1

**Screen Barcodes**



@DETPFN0

**\*\* Paper Barcodes**

## Sensitivity (Sense Mode)

This specifies the degree of acuteness of the scanner's response to changes in images captured. There are 20 levels to choose from. The smaller the value, the higher the sensitivity and the lower requirement in image change to trigger the scanner. You can select an appropriate degree of sensitivity that fits your application environment. This feature is only applicable to the Sense mode.



@SENLVL14

**Low Sensitivity**



@SENLVL11

**\*\* Medium Sensitivity**



@SENLVL8

**High Sensitivity**



@SENLVL5

**Enhanced Sensitivity**



@SENLVL

**Custom Sensitivity (Level 1-20)-**



@SETUPE0

**\*\* Exit Setup**



@SETUPE1

**Enter Setup**

---

**E**  
*sample*

**Set the sensitivity to Level 10:**

1. Scan the **Enter Setup** barcode.
2. Scan the **Custom Sensitivity** barcode.
3. Scan the numeric barcodes “1” and “0” from the “Digit Barcodes” section in Appendix.
4. Scan the **Save** barcode from the “Save/Cancel Barcodes” section in Appendix.
5. Scan the **Exit Setup** barcode.

## Scanning Preference

**Normal Mode:** Select this mode when reading barcodes on paper.

**Screen Mode:** Select this mode when reading barcodes on the screen.



@EXPLVL0

**\*\* Normal Mode**



@EXPLVL2

**Screen Mode**

## Read Barcode On/Off

Sending the Read Barcode Off command `~<SOH>0000#SCNENA0;<ETX>` to the scanner can disable it from reading barcode, and the scanner is unable to scan barcode unless you send the Read Barcode On command

`~<SOH>0000#SCNENA1;<ETX>` to it or power cycle it. By default, Read Barcode is On.



@SETUPE0

**\*\* Exit Setup**



@SETUPE1  
Enter Setup

## Smart Stand Mode

After this feature is turned on, the scanner will switch from its current scan mode to the Sense mode when it is inserted in the stand, and it will operate in its previous scan mode when it is removed from the stand.



@SMTENA0  
Off



@SMTENA1  
\*\* On

## Decode Area

**Whole Area Decoding:** The scanner attempts to decode barcode(s) within its field of view, from the center to the periphery, and transmits the barcode that has been first decoded.

**Specific Area Decoding:** The scanner attempts to read barcode(s) within a specified decoding area and transmits the barcode that has been first decoded. This option allows the scanner to narrow its field of view to make sure it reads only those barcodes intended by the user. For instance, if multiple barcodes are placed closely together, specific area decoding in conjunction with appropriate pre-defined decoding area will insure that only the desired barcode is read.

**Acuscan:** The scanner only decodes the barcode aimed squarely by the aiming pattern. For those using a crosshair aiming pattern, only the barcode aimed by the center of crosshair will be decoded.



@CADENA0  
\*\* Whole Area Decoding



@CADENA1  
Specific Area Decoding



@CADENA2  
Acuscan



@SETUPE0  
\*\* Exit Setup



@SETUPE1

**Enter Setup**

---

If **Specific Area Decoding** is enabled, the scanner only reads barcodes that intersect the predefined decoding area.

The default decoding area is an area of 40% top, 60% bottom, 40% left and 60% right of the scanner's field of view

You can define the decoding area using the **Top of Decoding Area**, **Bottom of Decoding Area**, **Left of Decoding Area** and **Right of Decoding Area** barcodes as well as numeric barcode(s) that represent(s) a desired percentage (0-100). The value of Bottom must be greater than that of Top; the value of Right must be greater than that of Left.



@CADTOP

**Top of Decoding Area**



@CDBOT

**Bottom of Decoding Area**



@CADLEF

**Left of Decoding Area**



@CADRIG

**Right of Decoding Area**



@SETUPE0

**\*\* Exit Setup**



@SETUPE1  
Enter Setup

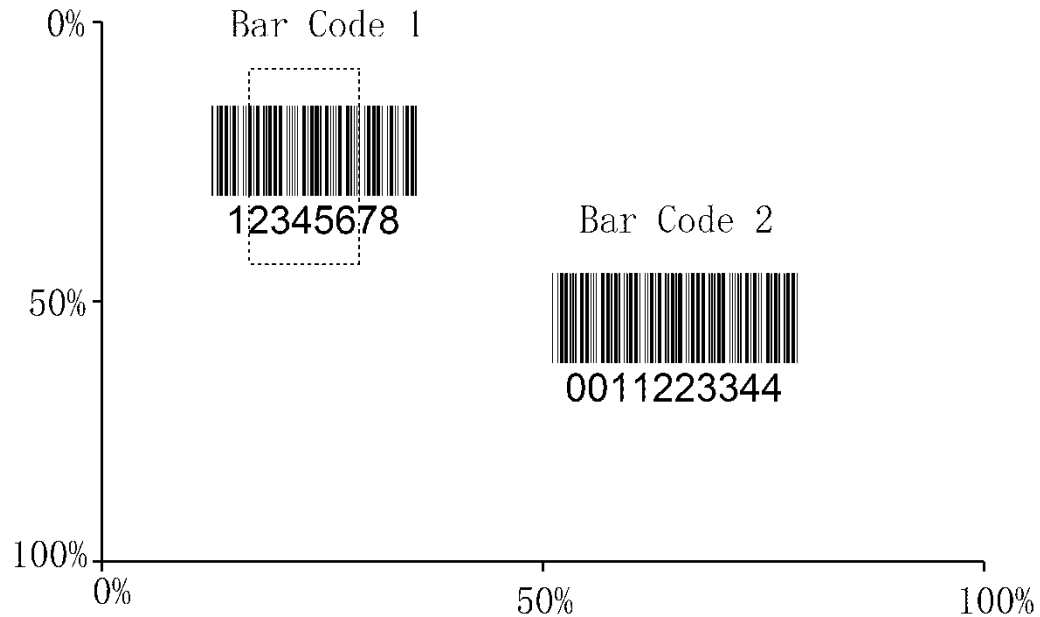

## **E** *sample*

**Program the scanner to only read Barcode 1 in the figure above by setting the decoding area to 10% top, 45% bottom, 15% left and 30% right:**

1. Scan the **Enter Setup** barcode.
2. Scan the **Top of Decoding Area** barcode.
3. Scan the numeric barcode "0" from the "Digit Barcodes" section in Appendix.
4. Scan the **Save** barcode from the "Save/Cancel Barcodes" section in Appendix.
5. Scan the **Bottom of Decoding Area** barcode.
6. Scan the numeric barcodes "4" and "5" from the "Digit Barcodes" section in Appendix.
7. Scan the **Save** barcode from the "Save/Cancel Barcodes" section in Appendix.
8. Scan the **Top of Decoding Area** barcode.
9. Scan the numeric barcodes "1" and "0" from the "Digit Barcodes" section in Appendix.
10. Scan the **Save** barcode from the "Save/Cancel Barcodes" section in Appendix.
11. Scan the **Left of Decoding Area** barcode.
12. Scan the numeric barcode "0" from the "Digit Barcodes" section in Appendix.
13. Scan the **Save** barcode from the "Save/Cancel Barcodes" section in Appendix.
14. Scan the **Right of Decoding Area** barcode.
15. Scan the numeric barcodes "3" and "0" from the "Digit Barcodes" section in Appendix.
16. Scan the **Save** barcode from the "Save/Cancel Barcodes" section in Appendix.



@SETUPE0  
**\*\* Exit Setup**



@SETUPE1

### Enter Setup

---

17. Scan the **Left of Decoding Area** barcode.
18. Scan the numeric barcodes "1" and "5" from the "Digit Barcodes" section in Appendix.
19. Scan the **Save** barcode from the "Save/Cancel Barcodes" section in Appendix.
20. Scan the **Exit Setup** barcode.



@SETUPE0

**\*\* Exit Setup**



@SETUPE1  
Enter Setup

## Image Flipping



@MIRROR0

\*\* Do Not Flip



@MIRROR1

Flip Horizontally



@MIRROR2

Flip Vertically



@MIRROR3

Flip Horizontally & Vertically

Example of image not flipped



Example of image flipped horizontally



Example of image flipped vertically



Example of image flipped horizontally & vertically



@SETUPE0  
\*\* Exit Setup



@SETUPE1

**Enter Setup**

---

## Bad Read Message

You may scan the appropriate barcode below to select whether or not to send a bad read message (user-programmable) when a good read does not occur before trigger release, or the decode session timeout expires.



@NGRENA0

**\*\* Bad Read Message OFF**



@NGRENA1

**Bad Read Message ON**

## Set Bad Read Message

A bad read message can contain up to 7 characters (HEX values from 0x00 to 0xFF). To set a bad read message, scan the **Set Bad Read Message** barcode, the numeric barcodes representing the hexadecimal values of desired character(s) and the **Save** barcode. The default setting is “NG”.



@NGRSET

**Set Bad Read Message**

**E**  
*xample*

**Set the bad read message to “F” (HEX: 0x46):**

1. Scan the **Enter Setup** barcode.
2. Scan the **Set Bad Read Message** barcode.
3. Scan the numeric barcodes “4” and “6” from the “Digit Barcodes” section in Appendix.
4. Scan the **Save** barcode from the “Save/Cancel Barcodes” section in Appendix.
5. Scan the **Exit Setup** barcode.



@SETUPE0

**\*\* Exit Setup**





@SETUPE1  
Enter Setup

---

## Power Off/Battery Off



@PWROFF

**Power Off Scanner**



@TESTMD3

**Battery Off**

(For Long-term Storage/Shipping)

Note: After scanning the **Battery Off** barcode, you MUST insert the scanner in a powered cradle to exit battery protection mode before turning it on.

## Default Settings

### Factory Defaults

Scanning the **Reset Scanner/Reset Cradle** barcode can restore the scanner/cradle to the factory defaults.

You may need to reset your scanner/cradle when:

1. Scanner/cradle is not properly configured so that the scanner fails to decode barcodes or to communicate with the cradle.
2. you forget previous configuration and want to avoid its impact.
3. functions that are rarely used have been enabled for the time being.



@FACDEF

**Reset Scanner**



@BASDFD

**Reset Crad**

### Custom Defaults

---



@SETUPE0

**\*\* Exit Setup**



@SETUPE1

### Enter Setup

---

Scanning the **Restore All Custom Defaults** barcode can reset all parameters on the scanner to the custom defaults.

Scanning the **Save as Custom Defaults** barcode can set the current settings as custom defaults.

Custom defaults are stored in the non-volatile memory.



@CUSSAV

### Save as Custom Defaults



@CUSDEF

### Restore All Custom Defaults



Restoring the scanner to the factory defaults will not remove the custom defaults from the scanner.



@SETUPE0

### \*\* Exit Setup



@SETUPE1  
Enter Setup

---

## Query Scanner Information

After scanning the barcode below, the scanner information (including product name, firmware version, decoder version, hardware version, product serial number, OEM serial number and manufacturing date) will be sent to the host device.



@QRYSYS

**Query Scanner Information**

## Query Product Name



@QRYPDN

**Query Product Name Query Firmware Version**



@QRYFWW

**Query Firmware Version**

## Query Decoder Version



@QRYDCV

**Query Decoder Version**

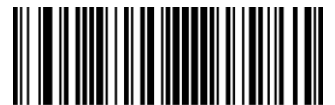

@SETUPE0  
**\*\* Exit Setup**



@SETUPE1

Enter Setup

---

### Query Bluetooth Hardware Version



#QRYBFW

Query Bluetooth Hardware Version

### Query Data Formatter Version



@QRYDFM

Query Data Formatter Version

### Query Hardware Version



@QRYHWW

Query Hardware Version

### Query Serial Number



@QRYPSN

Query Serial Number

### Query Manufacturing Date



@SETUPE0

\*\* Exit Setup



@SETUPE1  
**Enter Setup**

---



@QRYDAT  
**Query Manufacturing Date**



@SETUPE0  
**\*\* Exit Setup**



@SETUPE1  
Enter Setup

---

### Query OEM Serial Number



@QRYESN  
Query OEM Serial Number

### Query Cradle Information

After scanning the barcode below, the cradle information (including model number, firmware version, hardware information, product serial number, and manufacturing date) will be sent to the host device.



@BASQSY  
Query Cradle Information

### Query Model Number



@BASQHN  
Query Model Number

### Query Firmware Version



@BASQFW  
Query Firmware Version



@SETUPE0  
\*\* Exit Setup



@SETUPE1  
Enter Setup

---

### Query Hardware Information



@BASQHW

Query Hardware Information

### Query Cradle Bluetooth Hardware Version



#BASQBF

Query Cradle Bluetooth Hardware  
Version

### Query Serial Number



@BASQSN

Query Serial Number

### Query OEM Serial Number (ESN)



@BASQES

Query OEM Serial Number



@SETUPE0  
\*\* Exit Setup



@SETUPE1

**Enter Setup**

---

**Query Manufacturing Date**



@QRYDAT

**Query Manufacturing Date**



@SETUPE0

**\*\* Exit Setup**





@SETUPE1  
Enter Setup

---

### Query Remaining Battery of Scanner

After scanning the barcode below, the percentage of battery power remaining will be sent to the host device.



@WLSQPW

**Query Remaining Battery of Scanner**



@SETUPE0  
\*\* Exit Setup



@SETUPE1  
Enter Setup

## Chapter 4 RS-232 Interface

### Introduction

When the cradle is connected to the RS-232 port of a host device, you need to set communication parameters (including baud rate, parity check, data bit and stop bit) on the cradle to match the host device so that two devices can communicate with each other.



@INTERF0  
RS-232

### Datalogic Magellan Aux-RS232

Scanning the following barcode to program the scanner for a Datalogic Magellan Aux-RS232 port configuration.



@INTERF14  
Datalogic Magellan AUX-RS232

Note: A specific data cable is necessary for the Datalogic Magellan Aux-RS232 port. Please contact salesperson to buy CBL-125R or CBL-128R cable

### Baud Rate

Baud rate is the number of bits of data transmitted per second. Set the baud rate to match the host requirements.



@232BAD8  
\*\* 115200



@232BAD7  
57600



@232BAD6  
38400



@SETUPE0  
\*\* Exit Setup



\*  
\*  
N  
o  
n  
e

## Parity Check

Set the parity type to match the host requirements.

**Odd Parity:** If the data contains an odd number of 1 bits, the parity bit value is set to 0.

**Even Parity:** If the data contains an even number of 1 bits, the parity bit value is set to 0.

**None:** Select this option when no parity bit is required.





@SETUPE1

**Enter Setup**

**2400**



@232PAR1

**Even Parity**



@232PAR2

**Odd Parity**



@SETUPE0

**\*\* Exit Setup**



@SETUPE1

**Enter Setup**

---

## Data Bit

Set the number of data bits to match the host requirements.



@232DAT1

**7 Data Bits**



@232DAT0

**\*\* 8 Data Bits**

## Stop Bit

The stop bit(s) at the end of each transmitted character marks the end of transmission of one character and prepares the receiving device for the next character in the serial data stream. Set the number of stop bits to match the host requirements.



@232STP0

**\*\* 1 Stop Bit**



@232STP1

**2 Stop Bits**



@SETUPE0

**\*\* Exit Setup**



@SETUPE1

Enter Setup

---

## Hardware Auto Flow Control

If CTS flow control is enabled, the cradle determines whether to transmit data based on CTS signal level. When CTS signal is at low level which means the serial port's cache memory of receiving device (such as PC) is full, the cradle stops sending data through serial port until CTS signal is set to high level by receiving device. If RTS flow control is enabled, whether the cradle receives data or not is dependent on RTS signal level. If the cradle is not ready for receiving, it will set RTS signal to low level. When sending device (such as PC) detects it, it will not send data to the cradle any more to prevent data loss.

If **No Flow Control** is selected, reception/transmission of serial data will not be influenced by RTS/CTS signal.



@232FLW0

**\*\* No Flow Control**



@232FLW1

**RTS Flow Control**



@232FLW2

**CTS Flow Control**



@232FLW3

**CTS/RTS Flow Control**



Before enabling this feature, make sure that RTS/CTS signal lines are contained in RS-232 cable. Without the signal lines, RS-232 communication errors will occur.



@SETUPE0

**\*\* Exit Setup**



@SETUPE1

**Enter Setup**

## Chapter 5 USB Interface

### Introduction

There are four options for USB connection between the cradle and host device:

- ✧ USB HID Keyboard: The cradle's transmission is simulated as USB keyboard input with no need for command configuration or a driver. Barcode data could be entered by the virtual keyboard directly and it is also convenient for the host device to receive data.
- ✧ USB CDC: It is compliant with the standard USB CDC class specifications defined by the USB-IF and allows the host device to receive data in the way as a serial port does. A driver is needed when using this feature.
- ✧ HID POS (POS HID Barcode Scanner): It is based on the HID interface, with no need for a custom driver. It excels virtual keyboard and traditional RS-232 interface in transmission speed.
- ✧ IBM SurePOS: It conforms to IBM (now Toshiba Global Commerce Solutions) 4698 USB scanner interface specifications.

When the cradle is connected to both USB and RS-232 ports on a host device, it will select the USB connection by default.



@SETUPE0

**\*\* Exit Setup**



@SETUPE1

Enter Setup

---

## USB HID Keyboard

When the cradle is connected to the USB port on a host device, you can enable the USB HID Keyboard feature by scanning the barcode below. The cradle's transmission will be simulated as USB keyboard input. The Host receives keystrokes on the virtual keyboard. It works on a Plug and Play basis and no driver is required.



@INTERF3

**\*\* USB HID Keyboard**



If the host device allows keyboard input, then no extra software is needed for HID Keyboard input.



@SETUPE0

**\*\* Exit Setup**





@SETUPE1

**Enter Setup**

---

## USB Country Keyboard Types

Keyboard layouts vary from country to country. The default setting is U.S. keyboard.



@KBWCTY0

**\*\* U.S. (English)**



@KBWCTY1

**Belgium**



@KBWCTY2

**Brazil**



@KBWCTY3

**Canada (French)**



@KBWCTY4

**Czechoslovakia**



@KBWCTY5

**Denmark**



@KBWCTY6

**Finland (Swedish)**



@SETUPE0

**\*\* Exit Setup**



@SETUPE1

**Enter Setup**

---



@KBWCTY7

**France**



@KBWCTY8

**Germany/ Austria**



@KBWCTY9

**Greece**



@KBWCTY10

**Hungary**



@KBWCTY11

**Israel (Hebrew)**



@KBWCTY12

**Italy**



@KBWCTY13

**Latin America/ South America**



@KBWCTY14

**Netherlands (Dutch)**



@SETUPE0

**\*\* Exit Setup**



@SETUPE1

**Enter Setup**

---



@KBWCTY15

**Norway**



@KBWCTY16

**Poland**



@KBWCTY17

**Portugal**



@KBWCTY18

**Romania**



@KBWCTY19

**Russia**



@KBWCTY21

**Slovakia**



@KBWCTY22

**Spain**



@KBWCTY23

**Sweden**



@SETUPE0

**\*\* Exit Setup**



@SETUPE1

**Enter Setup**

---



@KBWCTY24

**Switzerland (German)**



@KBWCTY25

**Turkey\_F**



@KBWCTY26

**Turkey\_Q**



@KBWCTY27

**UK**



@KBWCTY28

**Japan**



@SETUPE0

**\*\* Exit Setup**



@SETUPE1

Enter Setup

## Emulate ALT+Keypad

When **Emulate ALT+Keypad** is turned on, any character whose ASCII value is greater than or equal to 0x20 is sent over the numeric keypad no matter which keyboard type is selected.

1. ALT Make
2. Enter the number corresponding to a desired character on the keypad.
3. ALT Break

After **Emulate ALT+Keypad ON** is selected, you need to choose the code page with which the barcodes were created and to turn **Unicode Encoding** On or Off depending on the encoding used by the application software.



@KBWALTO

\*\* Emulate ALT+Keypad OFF



@KBWALT1

Emulate ALT+Keypad ON



Since sending a character involves multiple keystroke emulations, this method appears less efficient.



Supposing **Emulate ALT+Keypad** is ON, **Unicode Encoding** is Off, **Code Page 1252 (West European Latin)** is selected, and **Emulate Keypad with Leading Zero** is Off, barcode data "ADF" (65/208/70) is sent as below:

"A" -- "ALT Make" + "065" + "ALT Break"

"D" -- "ALT Make" + "208" + "ALT Break"

"F" -- "ALT Make" + "070" + "ALT Break"



@SETUPE0

\*\* Exit Setup



@SETUPE1

Enter Setup

---

### Code Page

Code pages define the mapping of character codes to characters. If the data received does not display with the proper characters, it may be because the barcode being scanned was created using a code page that is different from the one the host program is expecting. If this is the case, select the code page with which the barcodes were created by scanning the appropriate barcode below. For PDF417, QR Code, Aztec and Data Matrix, besides setting the code page, you also need to set the character encoding in the “Character Encoding” section in Chapter 7. This feature is only effective when **Emulate ALT+Keypad** is turned on.



@KBWCPG0

**\*\* Code Page 1252 (West European Latin)**



@KBWCPG1

**Code Page 1251 (Cyrillic)**



@KBWCPG2

**Code Page 1250 (Central and East European Latin)**



@KBWCPG3

**Code Page 1253 (Greek)**



@KBWCPG4

**Code Page 1254 (Turkish)**



@KBWCPG5

**Code Page 1255 (Hebrew)**



@SETUPE0

**\*\* Exit Setup**



@SETUPE1

**Enter Setup**

---



@KBWCPG6

**Code Page 1256 (Arabic)**



@KBWCPG7

**Code Page 1257 (Baltic)**



@KBWCPG8

**Code Page 1258 (Vietnamese)**



@KBWCPG9

**Code Page 936 (Simplified Chinese, GB2312, GBK)**



@KBWCPG10

**Code Page 950 (Traditional Chinese, Big5)**



@KBWCPG11

**Code Page 874 (Thai)**



@KBWCPG12

**Code Page 932 (Japanese, Shift-JIS)**



@SETUPE0

**\*\* Exit Setup**



@SETUPE1

Enter Setup

---

### Unicode Encoding

Different host program may use different character encodings for handling incoming barcode data. For instance, Microsoft Office Word uses Unicode encoding and therefore you should turn **Unicode Encoding** on, whereas Microsoft Office Excel or Notepad uses Code Page encoding and therefore you should turn **Unicode Encoding** off. This feature is only effective when **Emulate ALT+Keypad** is turned on.



@KBWCPU0

\*\* Off



@KBWCPU1

On

### Emulate Keypad with Leading Zero

You may turn this feature on to send character sequences sent over the numeric keypad as ISO characters which have a leading zero. For example, ASCII A transmits as "ALT MAKE" 0065 "ALT BREAK". This feature is only effective when **Emulate ALT+Keypad** is enabled.



@KBWALZ1

\*\* On



@KBWALZ0

Off



@SETUPE0

\*\* Exit Setup





@SETUPE1  
Enter Setup

## Function Key Mapping

When **Ctrl+ASCII Mode** is selected, function characters (0x00 - 0x1F) are sent as ASCII sequences.



@KBWFKM0  
\*\* Disable



@KBWFKM1  
Ctrl+ASCII Mode



@KBWFKM2  
Alt+Keypad Mode

## Example

If **Ctrl+ASCII Mode** is selected and other parameters of USB HID Keyboard adopt factory defaults, barcode data “A<HT>(i.e. Horizontal Tab)F” (0x41/0x09/0x46) is sent as below:

“A” - Keystroke “A”.

<HT> - “Ctrl Make” + Keystroke “I” + “Ctrl Break”

“F” - Keystroke “F”

For some text editors, “Ctrl I” means italic convert. So the output may be “AF”.

If **Alt+Keypad Mode** is selected and other parameters of USB HID Keyboard adopt factory defaults, the data above is sent as below:

“A” - Keystroke “A”.

<HT> - “Alt Make” + Keystrokes “009” + “Alt Break”

“F” - Keystroke “F”



@SETUPE0  
\*\* Exit Setup



@SETUPE1

Enter Setup

### ASCII Function Key Mapping Table

| ASCII Function | ASCII Value (HEX) | Function Key Mapping Disabled | Ctrl+ASCII |
|----------------|-------------------|-------------------------------|------------|
| NUL            | 00                | Null                          | Ctrl+@     |
| SOH            | 01                | Keypad Enter                  | Ctrl+A     |
| STX            | 02                | Caps Lock                     | Ctrl+B     |
| ETX            | 03                | ALT                           | Ctrl+C     |
| EOT            | 04                | Null                          | Ctrl+D     |
| ENQ            | 05                | CTRL                          | Ctrl+E     |
| ACK            | 06                | Null                          | Ctrl+F     |
| BEL            | 07                | Enter                         | Ctrl+G     |
| BS             | 08                | Left Arrow                    | Ctrl+H     |
| HT             | 09                | Horizontal Tab                | Ctrl+I     |
| LF             | 0A                | Down Arrow                    | Ctrl+J     |
| VT             | 0B                | Vertical Tab                  | Ctrl+K     |
| FF             | 0C                | Delete                        | Ctrl+L     |
| CR             | 0D                | Enter                         | Ctrl+M     |
| SO             | 0E                | Insert                        | Ctrl+N     |
| SI             | 0F                | Esc                           | Ctrl+O     |
| DLE            | 10                | F11                           | Ctrl+P     |
| DC1            | 11                | Home                          | Ctrl+Q     |
| DC2            | 12                | PrintScreen                   | Ctrl+R     |
| DC3            | 13                | Backspace                     | Ctrl+S     |
| DC4            | 14                | tab+shift                     | Ctrl+T     |
| NAK            | 15                | F12                           | Ctrl+U     |
| SYN            | 16                | F1                            | Ctrl+V     |
| ETB            | 17                | F2                            | Ctrl+W     |
| CAN            | 18                | F3                            | Ctrl+X     |
| EM             | 19                | F4                            | Ctrl+Y     |
| SUB            | 1A                | F5                            | Ctrl+Z     |
| ESC            | 11                | F6                            | Ctrl+[     |
| FS             | 1C                | F7                            | Ctrl+\     |
| GS             | 1D                | F8                            | Ctrl+]     |
| RS             | 1E                | F9                            | Ctrl+6     |
| US             | 1F                | F10                           | Ctrl+-     |



@SETUPE0

\*\* Exit Setup



@SETUPE1

Enter Setup

### ASCII Function Key Mapping Table (Continued)

The last five characters (0x1B~0x1F) in the table above apply to US keyboard layout only. The following chart provides the equivalents of these five characters for other countries.

| Country        | Ctrl+ASCII |        |         |        |        |  |
|----------------|------------|--------|---------|--------|--------|--|
| United States  | Ctrl+[     | Ctrl+\ | Ctrl+]  | Ctrl+6 | Ctrl+- |  |
| Belgium        | Ctrl+[     | Ctrl+< | Ctrl+]  | Ctrl+6 | Ctrl+- |  |
| Scandinavia    | Ctrl+8     | Ctrl+< | Ctrl+9  | Ctrl+6 | Ctrl+- |  |
| France         | Ctrl+^     | Ctrl+8 | Ctrl+\$ | Ctrl+6 | Ctrl+= |  |
| Germany        |            | Ctrl+Ã | Ctrl++  | Ctrl+6 | Ctrl+- |  |
| Italy          |            | Ctrl+\ | Ctrl++  | Ctrl+6 | Ctrl+- |  |
| Switzerland    |            | Ctrl+< | Ctrl+.. | Ctrl+6 | Ctrl+- |  |
| United Kingdom | Ctrl+[     | Ctrl+ç | Ctrl+]  | Ctrl+6 | Ctrl+- |  |
| Denmark        | Ctrl+8     | Ctrl+\ | Ctrl+9  | Ctrl+6 | Ctrl+- |  |
| Norway         | Ctrl+8     | Ctrl+\ | Ctrl+9  | Ctrl+6 | Ctrl+- |  |
| Spain          | Ctrl+[     | Ctrl+\ | Ctrl+]  | Ctrl+6 | Ctrl+- |  |



@SETUPE0

\*\* Exit Setup



@SETUPE1

**Enter Setup**

---

## Inter-Keystroke Delay

This parameter specifies the delay between emulated keystrokes.



@KBWDLY0

**\*\* No Delay**



@KBWDLY40

**Long Delay (40ms)**

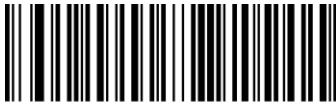

@KBWDLY20

**Short Delay (20ms)**



@SETUPE0

**\*\* Exit Setup**



@SETUPE1

Enter Setup

## Caps Lock

The **Caps Lock ON** option can invert upper and lower case characters contained in barcode data. This inversion occurs regardless of the state of Caps Lock key on the host device's keyboard.



@KBWCAP0

\*\* Caps Lock OFF (Non-Japanese keyboard)



@KBWCAP1

Caps Lock ON (Non-Japanese keyboard)



Emulate ALT+Keypad ON/ Convert All to Upper Case/ Convert All to Lower Case prevails over Caps Lock ON.



When the **Caps Lock ON** feature is selected, barcode data "AbC" is transmitted as "aBc".



@SETUPE0

\*\* Exit Setup



@SETUPE1

**Enter Setup**

---

## Convert Case

You may scan the appropriate barcode below to convert all barcode data to your desired case.



@KBWCAS0

**\*\* No Case Conversion**



@KBWCAS1

**Convert All to Upper Case**



@KBWCAS2

**Convert All to Lower Case**

**E**  
*xample*

When the **Convert All to Lower Case** feature is enabled, barcode data "AbC" is transmitted as "abc".



If **Emulate ALT+Keypad ON** is selected, **Convert All to Lower Case** and **Convert All to Upper Case** do not function.



@SETUPE0

**\*\* Exit Setup**



@SETUPE1

Enter Setup

## Emulate Numeric Keypad



**Do Not Emulate Numeric Keypad 1:** Sending a number (0-9) is emulated as keystroke(s) on main keyboard.

**Emulate Numeric Keypad 1:** Sending a number (0-9) is emulated as keystroke(s) on numeric keypad. The state of Num Lock on the simulated numeric keypad is determined by its equivalent on the host device. If Num Lock on the host device is turned off, the output of simulated numeric keypad is function key instead of number.

**Do Not Emulate Numeric Keypad 2:** Sending "+", "-", "\*", and "/" is emulated as keystroke(s) on main keyboard.

**Emulate Numeric Keypad 2:** Sending "+", "-", "\*", and "/" is emulated as keystroke(s) on numeric keypad.



@KBWNUM0

**\*\* Do Not Emulate Numeric Keypad 1**



@KBWNUM1

**Emulate Numeric Keypad 1**



@SETUPE0

**\*\* Exit Setup**



@SETUPE1

Enter Setup

---



@KBWNCH0

**\*\* Do Not Emulate Numeric Keypad 2**



@KBWNCH1

**Emulate Numeric Keypad 2**



**Emulate ALT+Keypad ON** prevails over **Emulate Numeric Keypad**.

**E**  
*xample*

Supposing the **Emulate Numeric Keypad 1** feature is enabled:

if Num Lock on the host device is ON, "A4.5" is transmitted as "A4.5";

if Num Lock on the host device is OFF, "A4.5" is transmitted as ".A":

1. "A" is sent on main keyboard;
2. "4" is sent as the function key "Cursor Move to Left";
3. "." is sent on main keyboard;
4. "5" is not sent as it does not correspond to any function key.



@SETUPE0

**\*\* Exit Setup**





@SETUPE1

**Enter Setup**

---

## Polling Rate

This parameter specifies the polling rate for a USB keyboard. If the Host drops characters, change the polling rate to a bigger value.



@KBWPOR0

**1ms**

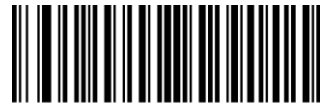

@KBWPOR1

**2ms**



@KBWPOR2

**3ms**

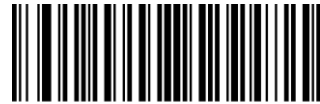

@KBWPOR3

**\*\* 4ms**



@KBWPOR4

**5ms**



@KBWPOR5

**6ms**



@KBWPOR6

**7ms**



@SETUPE0

**\*\* Exit Setup**



@SETUPE1

**Enter Setup**

---



@KBWPOR7

**8ms**



@KBWPOR8

**9ms**



@KBWPOR9

**10ms**



@SETUPE0

**\*\* Exit Setup**



@SETUPE1

**Enter Setup**

---

## USB CDC

If your cradle is connected to the USB port on a host device, the USB CDC feature allows the host device to receive data in the way as a serial port does. A driver is needed when using this feature. You may download it from our website at [www.newlandaidc.com](http://www.newlandaidc.com).



@INTERF8

**USB CDC**



@SETUPE0

**\*\* Exit Setup**



@SETUPE1

**Enter Setup**

---

## **HID POS (POS HID Barcode Scanner)**

### **Introduction**

The HID-POS interface is recommended for new application programs. It can send up to 56 characters in a single USB report and appears more efficient than keyboard emulation.

Features:

1. HID based, no custom driver required.
2. Way more efficient in communication than keyboard emulation and traditional RS-232 interface.



@INTERF5

**USB HID-POS**

### **Access the Cradle with Your Program**

Use CreateFile to access the cradle as a HID device and then use ReadFile to deliver the scanned data to the application program. Use WriteFile to send data to the cradle.

For detailed information about USB and HID interfaces, go to [www.USB.org](http://www.USB.org).



@SETUPE0

**\*\* Exit Setup**



@SETUPE1

Enter Setup

### Acquire Scanned Data

After a barcode is decoded, the cradle sends an input report as below:

| Byte  | Bit                                       |   |   |   |   |   |   |                        |
|-------|---|---|---|---|---|---|---|------------------------|
|       | 7   | 6 | 5 | 4 | 3 | 2 | 1 | 0                      |
| 0     | Report ID = 0x02                          |   |   |   |   |   |   |                        |
| 1     | Barcode Length                            |   |   |   |   |   |   |                        |
| 2-57  | Decoded Data (1-56)                       |   |   |   |   |   |   |                        |
| 58-61 | Reserved                                  |   |   |   |   |   |   |                        |
| 62    | Newland Symbology Identifier or N/C: 0x00 |   |   |   |   |   |   |                        |
| 63    | -   | - | - | - | - | - | - | Decoded data continued |

### Send Command to the Cradle

This output report is used to send commands to the cradle. All programming commands can be used.

| Byte | Bit               |   |   |   |   |   |   |   |
|------|-------------------|---|---|---|---|---|---|---|
|      | 7                 | 6 | 5 | 4 | 3 | 2 | 1 | 0 |
| 0    | Report ID = 0x04  |   |   |   |   |   |   |   |
| 1    | Length of command |   |   |   |   |   |   |   |
| 2-63 | Command (1-62)    |   |   |   |   |   |   |   |



@SETUPE0

\*\* Exit Setup



@SETUPE1

**Enter Setup**

---

## VID/PID

USB uses VID (Vendor ID) and PID (Product ID) to identify and locate a device. The VID is assigned by USB Implementers Forum. Newland's vendor ID is 1EAB (Hex). A range of PIDs are used for each Newland product family. Every PID contains a base number and interface type (keyboard, COM port, etc)

| Product | Interface              | PID (Hex) | PID (Dec) |
|---------|------------------------|-----------|-----------|
| CD32    | USB HID Keyboard       | 1403      | 5123      |
|         | USB CDC                | 1406      | 5126      |
|         | HID POS                | 1410      | 5136      |
|         | IBM SurePOS (Tabletop) | 1420      | 5152      |
|         | IBM SurePOS (Handheld) | 1421      | 5153      |



@SETUPE0

**\*\* Exit Setup**

## Chapter 6 Wireless Communication

### Default Setting of Wireless Communication

#### Restore Cradle Factory Information



#### Clear Pairing Information of Cradle



#### Clear Pairing Information of Scanner





@SETUPE1

Enter Setup

---

## Operating Modes

The scanner provides the following two operating modes:

**Bluetooth HID Mode** allows your scanner to communicate with a remote host using Bluetooth. You must first pair your scanner to the host before these two Bluetooth devices can communicate with each other. All features available for USB HID Keyboard are applicable to Bluetooth HID. Pressing the trigger twice can turn on/off iPhone and iPad's virtual keyboard.

Note: The pairing information in the scanner and the current host need to be cleared before connecting with other Bluetooth devices.

Scanner scan Clear Pairing Info on Scanner barcode, and the host delete the pairing information.

In **Bluetooth HID/BLE Mode**, when you have many scanners to pair, you can pair the exact one via scan the barcode in the EasyConnect to communicate with the host.

**Cradle Mode** allows your scanner to communicate with a remote host by pairing with a cradle.



@INTERF12

\*\* Cradle Mode



@INTERF10

Bluetooth HID Mode



@INTERF11

Bluetooth BLE



@SETUPE0

\*\* Exit Setup





@SETUPE1

Enter Setup

## Batch Mode

### Batch Mode Options

**Off:** The scanner attempts to transmit every barcode you scan. When you are out of service range, the scanned data will be lost.

**Automatic Batch Mode:** When in service range, the scanner attempts to transmit every barcode you scan. When out of range, the scanner stores the scanned data in the flash memory. Once you are back to service range, the scanner will automatically transmit the stored data and then remove it from the flash memory after transmission is done.

**Manual Batch Mode:** Scanned data will be stored in the flash memory no matter whether you are in service range or not. You may send the stored data to the host in either of the following ways: (i) press the Batch button on the cradle after inserting the scanner in cradle; or (ii) scan the Transmit Stored Data barcode. The scanner will automatically remove the stored data from the flash memory after transmission is done if the Auto Clear Stored Data after Transmission feature is turned on.

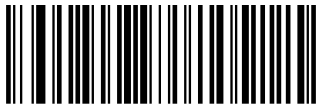

@WLSBAT0

**\*\*Off**



@WLSBAT1

**Automatic Batch Mode**

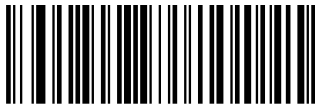

@WLSBAT2

**Manual Batch Mode**

### Prevent Same Barcode Storage

This feature is available only when scanning barcodes in the Automatic or Manual Batch mode.

**On:** The scanner discards the data and generates an error beep when encountering a barcode that has existed in the flash memory.



@SETUPE0

**\*\* Exit Setup**



@SETUPE1

**Enter Setup**

---

**Off:** The scanner stores the data when encountering a barcode that has existed in the flash memory.



@WLSSE0

**\*\* Off**



@WLSSE1

**On**



@SETUPE0

**\*\* Exit Setup**

---

## Batch Mode Transmit Delay

Sometimes when multiple barcodes stored in the flash memory are sent to the host, the transmission of those barcodes is too fast for the application to process. To program a transmit delay between barcodes, scan one of the following delays.



**\*\* No Transmit Delay (0ms)**



**Short Transmit Delay (50ms)**



**Medium Transmit Delay (100ms)**



**Long Transmit Delay (150ms)**



**Custom Transmit Delay (0-10,000ms)**

## **E** *xample*

**Set the batch mode transmit delay to 200ms:**

1. Scan the **Enter Setup** barcode.
2. Scan the **Custom Transmit Delay** barcode.
3. Scan the numeric barcodes "2", "0" and "0" from the "Digit Barcodes" section in Appendix.
4. Scan the **Save** barcode from the "Save/Cancel Barcodes" section in Appendix.
5. Scan the **Exit Setup** barcode.



@SETUPE1

**Enter Setup**

---

### End of Transmission Message for Batch Mode

You may scan the appropriate barcode below to select whether or not to send an end of transmission message (user-programmable) to notify the host when transmission of all stored data is done. This feature is only available to data transmission initiated manually under the Manual Batch mode.



@WLSBTT0

**\*\* End of Transmission Message Off**



@WLSBTT1

**End of Transmission Message On**

An end of transmission message can contain up to 10 characters (HEX values from 0x00 to 0xFF). To set an end of transmission message, scan the **Set End of Transmission Message** barcode, the numeric barcodes representing the hexadecimal values of desired character(s) and the **Save** barcode. The default setting is "EOT".



@WLSBTC

**Set End of Transmission Message**

**E**  
*xample*

**Set the end of transmission message to "END" (HEX: 0x45, 0x4E, 0x44):**

1. Scan the **Enter Setup** barcode.
2. Scan the **Set End of Transmission Message** barcode.
3. Scan the numeric barcodes "4", "5", "4", "E", "4" and "4" from the "Digit Barcodes" section in Appendix.
4. Scan the **Save** barcode from the "Save/Cancel Barcodes" section in Appendix.
5. Scan the **Exit Setup** barcode.



@SETUPE0

**\*\* Exit Setup**



@SETUPE1

**Enter Setup**

---

### Transmit Stored Data

You may scan the barcode below to send the stored data in the flash memory to the host. This feature is only available to the Manual Batch mode.



@WLSSBT

**Transmit Stored Data**

### Auto Clear Stored Data after Transmission

You may scan the appropriate barcode below to choose whether to clear or keep the stored data in the flash memory after transmission. This feature is only available to the Manual Batch mode.



@WLSCLE0

**\*\* Off**



@WLSCLE1

**On**

### Query/Clear Stored Data in Flash



@WLSQFC

**Query the Number of Stored Barcodes**



@WLSCLF

**Clear All Stored Data**

---



@SETUPE0

**\*\* Exit Setup**



@SETUPE1

**Enter Setup**

---

## Retransmission

If the Transmission feature is on, the scanner awaits an ACK response from the host following a data packet transmission, and resends the packet when it receives a NAK response or the retransmission timeout expires. Note that Data Packing must be enabled for this feature to function (See the “Data Packing Options” in Chapter 9 to learn how to enable it).



@WLSRTE0

**\*\* Retransmission Off**



@WLSRTE1

**Retransmission On**



@SETUPE0

**\*\* Exit Setup**



@SETUPE1

Enter Setup

---

## Scanner(s) to Cradle Support

### Wireless Communication Modes

**Point-to-Point Mode:** Only one scanner can be paired to one cradle at a time.

**Multi-Point-to-Single Point Mode:** Up to seven scanners can be paired to one cradle.



@BASMPM0

**\*\* Point-to-Point Mode**



@BASMPM1

**Multi-Point-to-Single Point Mode**

### Clear Pairing Info on Scanner/Cradle



@BASCLP

**Clear Pairing Info on Cradle**



@WLSCLP

**Clear Pairing Info on Scanner**



@SETUPE0

**\*\* Exit Setup**



@SETUPE1

**Enter Setup**

---

## Auto Power-Off Timeout

Auto Power-off Timeout specifies the amount of time it takes before the scanner automatically powers off from inactivity.



@WLSAPO0

**\*\* 5 Minutes**



@WLSAPO1

**10 Minutes**



@WLSAPO2

**20 Mintues**



@WLSAPO3

**30 Mintues**



@WLSAPO4

**60 Minutes**



@WLSAPO5

**Disable Auto Power-off**



@SETUPE0

**\*\* Exit Setup**





@SETUPE1

Enter Setup

---

## Set Scanner Name

You may scan the below barcode to set the name of your scanner. The maximum length is 5 characters (HEX values from 0x20 to 0x7E). The default scanner name is "00000".



@WLSNAM

Scanner Name

**E**  
*example*

If setting the scanner name as "0AB00":

1. Scan the Enter Setup barcode
2. Scan the Scanner Name barcode
3. Scan the numeric barcode "3" "0" "4" "1" "4" "2" from the "Digit Barcodes" section in Appendix
4. Scan the **Save** barcode from the "Save/Cancel Barcodes" section in Appendix
5. Scan the Exit Setup barcode



@SETUPE0

\*\* Exit Setup



@SETUPE1

**Enter Setup**

---

## Set Date and Time



@WLSTMS

**Set Date and Time**

**E**  
*example*

Set Date and Time to “20201021010101”:

1. Scan the **Enter Setup** barcode.
2. Scan the **Set Date and Time** barcode.
3. Scan the numeric barcodes “2”, “0”, “2”, “0”, “1”, “0”, “2”, “1”, “0”, “1”, “0”, “1”, “0” and “1” from the “Digit Barcodes” section in Appendix.
4. Scan the **Save** barcode from the “Save/Cancel Barcodes” section in Appendix.
5. Scan the **Exit Setup** barcode.

## Query Current Date and Time

After scanning the barcode below, the current date and time in YYYYMMDDHHMMSS format will be sent to the host device.

For example, query result “20180205103011” means February 5<sup>th</sup> 2018 10:30:11.



@WLSTMQ

**Query Current Date and Time**

## Time Stamp

---



@SETUPE0

**\*\* Exit Setup**



@SETUPE1

**Enter Setup**

---

You can select whether or not to send date & time before each scanned data by scanning the appropriate barcode below.



@WLSTSE0

**\*\* Do Not Send Time Stamp**



@WLSTSE1

**Send Time Stamp**



@SETUPE0

**\*\* Exit Setup**



@SETUPE1

Enter Setup

---

### Set Time Stamp Format



@WLSTSF0

**\*\* Format 1: (YYYY/MM/DD, HH: MM: SS)**

(example: 2018/01/23, 10:30:20)



@WLSTSF1

**Format 2: (DD/MM/YYYY/, HH: MM: SS)**

(example: 23/01/2018, 10:30:20)



@WLSTSF2

**Format 3: (MM/DD/YYYY,HH:MM:SS)**

(example: 01/23/2018, 10:30:20)



@SETUPE0

**\*\* Exit Setup**



@SETUPE1

**Enter Setup**

---

## Host Acknowledgment

This feature is only applicable when Batch Mode is disabled. The green LED flashes once and makes the right beep to indicate the right result, and the host will send 0x06 to the scanner. The red LED flashes three times and make the wrong beep to indicate the wrong result, and the host will send 0x15 to the scanner.



@WLSCHK0

**\*\* Off**



@WLSCHK1

**On**

## Host Acknowledgment Timeout



@WLSCKT0

**\*\* 1 Second**



@WLSCKT1

**3 Seconds**

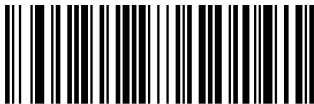

@WLSCKT2

**5 Seconds**



@SETUPE0

**\*\* Exit Setup**



@SETUPE1

**Enter Setup**

---

### Host Acknowledgment Beep Volume



@WLSVLL2

**Low**



@WLSVLL12

**Medium**



@WLSVLL20

**\*\* Loud**



@WLSVLL

**Custom (1-20)**



@SETUPE0

**\*\* Exit Setup**



@SETUPE1

Enter Setup

## Chapter 7 Symbologies

### Introduction

Every symbology (barcode type) has its own unique attributes. This chapter provides programming barcodes for configuring the scanner so that it can identify various symbologies. It is recommended to disable those that are rarely used to increase the efficiency of the scanner.

### Global Settings

#### Enable/Disable All Symbologies

If the **Disable All Symbologies** feature is enabled, the scanner will not be able to read any non-programming barcodes except the programming barcodes.



@ALLENA1

Enable All Symbologies



@ALLENA0

Disable All Symbologies

#### Enable/Disable 1D Symbologies



@ALL1DC1

Enable 1D Symbologies



@ALL1DC0

Disable 1D Symbologies



@SETUPE0

\*\* Exit Setup



@SETUPE1

**Enter Setup**

---

### Enable/Disable 2D Symbologies



@ALL2DC1

**Enable 2D Symbologies**



@ALL2DC0

**Disable 2D Symbologies**

### Enable/Disable Postal Symbologies



@ALLPST1

**Enable All Postal Symbologies**



@ALLPST0

**Disable All Postal Symbologies**



@SETUPE0

**\*\* Exit Setup**





@SETUPE1

Enter Setup

### Surround GS1 Application Identifiers (AI's) with Parentheses

When **Surround GS1 AI's with Parentheses** is selected, each application identifier (AI) contained in scanned data will be enclosed in parentheses in the output message.



@GS1AIP0

**\*\* Do Not Surround GS1 AI's with Parentheses**



@GS1AIP1

**Surround GS1 AI's with Parentheses**

**E**  
*xample*

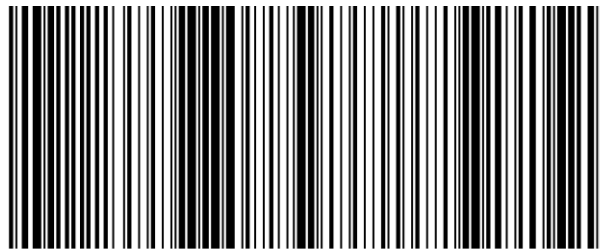

(01) 0 0614141 99999 6 (10) 10ABCEDF123456

If **Surround GS1 AI's with Parentheses** is selected, the barcode above is output as

(01)00614141999996(10)10ABCEDF123456.

If **Do Not Surround GS1 AI's with Parentheses** is selected, the barcode above is output as

01006141419999961010ABCEDF123456.



@SETUPE0

**\*\* Exit Setup**



@SETUPE1  
Enter Setup

### Transmit GS1 Check Character



@GS1OCK0  
Disable



@GS1OCK1  
\*\* Enable

## **E** *xample*

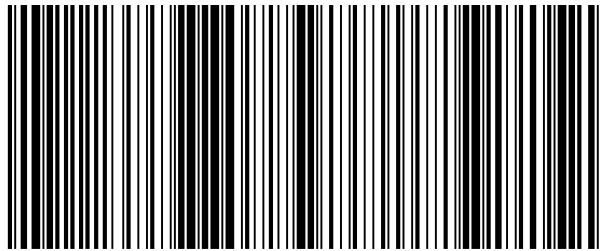

(01) 0 0614141 99999 6 (10) 10ABCEDF123456

If **Transmit GS1 Check Character** is Enabled, the barcode above is output as  
01006141419999961010ABCEDF123456.

If **Transmit GS1 Check Character** is Disabled, the barcode above is output as  
0100614141999991010ABCEDF123456.



@SETUPE0  
\*\* Exit Setup



@SETUPE1

**Enter Setup**

---

## Code 128

### Restore Factory Defaults



@128DEF

**\*\*Restore the Factory Defaults of Code 128**

### Enable/Disable Code 128



@128ENA1

**\*\* Enable Code 128**



@128ENA0

**Disable Code 128**



If the scanner fails to identify Code 128 barcodes, you may first try this solution by scanning the **Enter Setup** barcode and then **Enable Code 128** barcode.



@SETUPE0

**\*\* Exit Setup**



@SETUPE1  
**Enter Setup**

## Set Length Range for Code 128

The scanner can be configured to only decode Code 128 barcodes with lengths that fall between (inclusive) the minimum and maximum lengths. To accomplish it, you need to set the minimum and maximum lengths.



@128MIN  
**Set the Minimum Length (Default: 1)**



@128MAX  
**Set the Maximum Length (Default: 48)**



If minimum length is set to be greater than maximum length, the scanner only decodes Code 128 barcodes with either the minimum or maximum length. If minimum length is same as maximum length, only Code 128 barcodes with that length are to be decoded.



**Set the scanner to decode Code 128 barcodes containing between 8 and 12 characters:**

1. Scan the **Enter Setup** barcode.
2. Scan the **Set the Minimum Length** barcode.
3. Scan the numeric barcode “8” from the “Digit Barcodes” section in Appendix.
4. Scan the **Save** barcode from the “Save/Cancel Barcodes” section in Appendix.
5. Scan the **Set the Maximum Length** barcode.
6. Scan the numeric barcodes “1” and “2” from the “Digit Barcodes” section in Appendix.
7. Scan the **Save** barcode from the “Save/Cancel Barcodes” section in Appendix.
8. Scan the **Exit Setup** barcode.



@SETUPE0  
**\*\* Exit Setup**



@SETUPE1

Enter Setup

## EAN-8

### Restore Factory Defaults



@EA8DEF

\*\* Restore the Factory Defaults of EAN-8

### Enable/Disable EAN-8



@EA8ENA1

\*\* Enable EAN-8



@EA8ENA0

Disable EAN-8



If the scanner fails to identify EAN-8 barcodes, you may first try this solution by scanning the **Enter Setup** barcode and then **Enable EAN-8** barcode.

### Transmit Check Character

EAN-8 is 8 digits in length with the last one as its check character used to verify the integrity of the data.



@EA8CHK2

\*\* Transmit EAN-8 Check Character

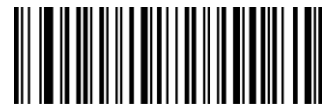

@EA8CHK1

Do Not Transmit EAN-8 Check Character



@SETUPE0

\*\* Exit Setup



@SETUPE1

Enter Setup

---

## 2-Digit Add-On Code

An EAN-8 barcode can be augmented with a two-digit add-on code to form a new one. In the example below, the part surrounded by blue dotted line is an EAN-8 barcode while the part circled by red dotted line is a two-digit add-on code.



@EA8AD20

**\*\* Disable 2-Digit Add-On Code**



@EA8AD21

**Enable 2-Digit Add-On Code**



**Disable 2-Digit Add-On Code:** The scanner decodes EAN-8 and ignores the add-on code when presented with an EAN-8 plus 2-digit add-on barcode. It can also decode EAN-8 barcodes without 2-digit add-on codes.

**Enable 2-Digit Add-On Code:** The scanner decodes a mix of EAN-8 barcodes with and without 2-digit add-on codes.



@SETUPE0

**\*\* Exit Setup**



@SETUPE1

Enter Setup

## 5-Digit Add-On Code

An EAN-8 barcode can be augmented with a five-digit add-on code to form a new one. In the example below, the part surrounded by blue dotted line is an EAN-8 barcode while the part circled by red dotted line is a five-digit add-on code.



@EA8AD50

**\*\* Disable 5-Digit Add-On Code**



@EA8AD51

**Enable 5-Digit Add-On Code**



**Disable 5-Digit Add-On Code:** The scanner decodes EAN-8 and ignores the add-on code when presented with an EAN-8 plus 5-digit add-on barcode. It can also decode EAN-8 barcodes without 5-digit add-on codes.

**Enable 5-Digit Add-On Code:** The scanner decodes a mix of EAN-8 barcodes with and without 5-digit add-on codes.



@SETUPE0

**\*\* Exit Setup**



@SETUPE1

Enter Setup

---

### Add-On Code Required

When **EAN-8 Add-On Code Required** is selected, the scanner will only read EAN-8 barcodes that contain add-on codes.



@EA8REQ0

\*\* EAN-8 Add-On Code Not Required



@E13REQ1

EAN-8 Add-On Code Required

### Convert EAN-8 to EAN-13

**Convert EAN-8 to EAN-13:** Convert EAN-8 decoded data to EAN-13 format before transmission. After conversion, the data follows EAN-13 format and is affected by EAN-13 programming selections (e.g., Check Character).

**Do Not Convert EAN-8 to EAN-13:** EAN-8 decoded data is transmitted as EAN-8 data, without conversion.



@EA8EXP0

\*\* Do Not Convert EAN-8 to EAN-13



@EA8EXP1

Convert EAN-8 to EAN-13



@SETUPE0

\*\* Exit Setup





@SETUPE1  
**Enter Setup**

---

## EAN-13

### Restore Factory Defaults



@E13DEF

**\*\* Restore the Factory Defaults of EAN-13**

### Enable/Disable EAN-13



@E13ENA1

**\*\* Enable EAN-13**



@E13ENA0

**Disable EAN-13**



If the scanner fails to identify EAN-13 barcodes, you may first try this solution by scanning the **Enter Setup** barcode and then **Enable EAN-13** barcode.



@SETUPE0  
**\*\* Exit Setup**



@SETUPE1  
Enter Setup

### Transmit Check Character



@E13CHK2

\*\* Transmit EAN-13 Check Character



@E13CHK1

Do Not Transmit EAN-13 Check Character

### 2-Digit Add-On Code

An EAN-13 barcode can be augmented with a two-digit add-on code to form a new one. In the example below, the part surrounded by blue dotted line is an EAN-13 barcode while the part circled by red dotted line is a two-digit add-on code.



@E13AD20

\*\* Disable 2-Digit Add-On Code



@E13AD21

Enable 2-Digit Add-On Code



**Disable 2-Digit Add-On Code:** The scanner decodes EAN-13 and ignores the add-on code when presented with an EAN-13 plus 2-digit add-on barcode. It can also decode EAN-13 barcodes without 2-digit add-on codes.

**Enable 2-Digit Add-On Code:** The scanner decodes a mix of EAN-13 barcodes with and without 2-digit add-on codes.



@SETUPE0

\*\* Exit Setup



@SETUPE1

Enter Setup

## 5-Digit Add-On Code

An EAN-13 barcode can be augmented with a five-digit add-on code to form a new one. In the example below, the part surrounded by blue dotted line is an EAN-13 barcode while the part circled by red dotted line is a five-digit add-on code.



@E13AD50

\*\* Disable 5-Digit Add-On Code



@E13AD51

Enable 5-Digit Add-On Code



**Disable 5-Digit Add-On Code:** The scanner decodes EAN-13 and ignores the add-on code when presented with an EAN-13 plus 5-digit add-on barcode. It can also decode EAN-13 barcodes without 5-digit add-on codes.

**Enable 5-Digit Add-On Code:** The scanner decodes a mix of EAN-13 barcodes with and without 5-digit add-on codes.

## Add-On Code Required

When **EAN-13 Add-On Code Required** is selected, the scanner will only read EAN-13 barcodes that contain add-on codes.



@E13REQ0

\*\* EAN-13 Add-On Code Not Required



@E13REQ1

EAN-13 Add-On Code Required



@SETUPE0

\*\* Exit Setup



@SETUPE1  
Enter Setup

---

### EAN-13 Beginning with 290 Add-On Code Required

This setting programs the scanner to require an add-on code (2-digit or 5-digit) on EAN-13 barcodes that begin with “290”. The following settings can be programmed:

**Require Add-On Code:** All EAN-13 barcodes that begin with “290” must have a 2-digit or 5-digit add-on code. The EAN-13 barcode with the add-on code is then transmitted. If the required add-on code is not found, the EAN-13 barcode is discarded.

**Do Not Require Add-On Code:** If you have selected **Require Add-On Code**, and you want to disable this feature, scan **Do Not Require Add-On Code**. EAN-13 barcodes are handled, depending on your selection for the “Add-On Code Required” feature.



\*\* Do Not Require Add-On Code



Require Add-On Code

### EAN-13 Beginning with 378/379 Add-On Code Required

This setting programs the scanner to require an add-on code (2-digit or 5-digit) on EAN-13 barcodes that begin with a “378” or “379”. The following settings can be programmed:

**Require Add-On Code:** All EAN-13 barcodes that begin with a “378” or “379” must have a 2-digit or 5-digit add-on code. The EAN-13 barcode with the add-on code is then transmitted. If the required add-on code is not found, the EAN-13 barcode is discarded.

**Do Not Require Add-On Code:** If you have selected **Require Add-On Code**, and you want to disable this feature, scan **Do Not Require Add-On Code**. EAN-13 barcodes are handled, depending on your selection for the “Add-On Code Required” feature.



\*\* Do Not Require Add-On Code



Require Add-On Code



@SETUPE0  
\*\* Exit Setup



@SETUPE1

Enter Setup

### EAN-13 Beginning with 414/419 Add-On Code Required

This setting programs the scanner to require an add-on code (2-digit or 5-digit) on EAN-13 barcodes that begin with a “414” or “419”. The following settings can be programmed:

**Require Add-On Code:** All EAN-13 barcodes that begin with a “414” or “419” must have a 2-digit or 5-digit add-on code. The EAN-13 barcode with the add-on code is then transmitted. If the required add-on code is not found, the EAN-13 barcode is discarded.

**Do Not Require Add-On Code:** If you have selected **Require Add-On Code**, and you want to disable this feature, scan **Do Not Require Add-On Code**. EAN-13 barcodes are handled, depending on your selection for the “Add-On Code Required” feature.



@E134140

**\*\* Do Not Require Add-On Code**



@E134141

**Require Add-On Code**

### EAN-13 Beginning with 434/439 Add-On Code Required

This setting programs the scanner to require an add-on code (2-digit or 5-digit) on EAN-13 barcodes that begin with a “434” or “439”. The following settings can be programmed:

**Require Add-On Code:** All EAN-13 barcodes that begin with a “434” or “439” must have a 2-digit or 5-digit add-on code. The EAN-13 barcode with the add-on code is then transmitted. If the required add-on code is not found, the EAN-13 barcode is discarded.

**Do Not Require Add-On Code:** If you have selected **Require Add-On Code**, and you want to disable this feature, scan **Do Not Require Add-On Code**. EAN-13 barcodes are handled, depending on your selection for the “Add-On Code Required” feature.



@E134340

**\*\* Do Not Require Add-On Code**



@E134341



@SETUPE0

**\*\* Exit Setup**



@SETUPE1

**Enter Setup**

**Require Add-On Code**

---



@SETUPE0

**\*\* Exit Setup**



@SETUPE1

Enter Setup

### EAN-13 Beginning with 977 Add-On Code Required

This setting programs the scanner to require an add-on code (2-digit or 5-digit) on EAN-13 barcodes that begin with “977”.

The following settings can be programmed:

**Require Add-On Code:** All EAN-13 barcodes that begin with “977” must have a 2-digit or 5-digit add-on code. The EAN-13 barcode with the add-on code is then transmitted. If the required add-on code is not found, the EAN-13 barcode is discarded.

**Do Not Require Add-On Code:** If you have selected **Require Add-On Code**, and you want to disable this feature, scan **Do Not Require Add-On Code**. EAN-13 barcodes are handled, depending on your selection for the “Add-On Code Required” feature.



@E139770

**\*\* Do Not Require Add-On Code**



@E139771

**Require Add-On Code**

### EAN-13 Beginning with 978 Add-On Code Required

This setting programs the scanner to require an add-on code (2-digit or 5-digit) on EAN-13 barcodes that begin with “978”.

The following settings can be programmed:

**Require Add-On Code:** All EAN-13 barcodes that begin with “978” must have a 2-digit or 5-digit add-on code. The EAN-13 barcode with the add-on code is then transmitted. If the required add-on code is not found, the EAN-13 barcode is discarded.

**Do Not Require Add-On Code:** If you have selected **Require Add-On Code**, and you want to disable this feature, scan **Do Not Require Add-On Code**. EAN-13 barcodes are handled, depending on your selection for the “Add-On Code Required” feature.



@E139780

**\*\* Do Not Require Add-On Code**



@E139781

**Require Add-On Code**



@SETUPE0

**\*\* Exit Setup**



@SETUPE1

Enter Setup

---

### EAN-13 Beginning with 979 Add-On Code Required

This setting programs the scanner to require an add-on code (2-digit or 5-digit) on EAN-13 barcodes that begin with “979”.

The following settings can be programmed:

**Require Add-On Code:** All EAN-13 barcodes that begin with “979” must have a 2-digit or 5-digit add-on code. The EAN-13 barcode with the add-on code is then transmitted. If the required add-on code is not found, the EAN-13 barcode is discarded.

**Do Not Require Add-On Code:** If you have selected **Require Add-On Code**, and you want to disable this feature, scan **Do Not Require Add-On Code**. EAN-13 barcodes are handled, depending on your selection for the “Add-On Code Required” feature.



@E139790

**\*\* Do Not Require Add-On Code**



@E139791

**Require Add-On Code**



@SETUPE0

**\*\* Exit Setup**





@SETUPE1

**Enter Setup**

---

## UPC-E

### Restore Factory Defaults



@UPEDEF

**\*\* Restore the Factory Defaults of UPC-E**

### Enable/Disable UPC-E



@UPEEN01

**\*\* Enable UPC-E0**



@UPEEN00

**Disable UPC-E0**



@UPEEN11

**Enable UPC-E1**



@UPEEN10

**\*\* Disable UPC-E1**



If the scanner fails to identify UPC-E0/UPC-E1 barcodes, you may first try this solution by scanning the **Enter Setup** barcode and then **Enable UPC-E0/UPC-E1** barcode.



@SETUPE0

**\*\* Exit Setup**



@SETUPE1  
Enter Setup

### Transmit Check Character

UPC-E is 8 digits in length with the last one as its check character used to verify the integrity of the data.



@UPECHK2  
**\*\* Transmit UPC-E Check Character**



@UPECHK1  
**Do Not Transmit UPC-E Check Character**

### 2-Digit Add-On Code

A UPC-E barcode can be augmented with a two-digit add-on code to form a new one. In the example below, the part surrounded by blue dotted line is a UPC-E barcode while the part circled by red dotted line is a two-digit add-on code.



@UPEAD20  
**\*\* Disable 2-Digit Add-On Code**



@UPEAD21  
**Enable 2-Digit Add-On Code**



**Disable 2-Digit Add-On Code:** The scanner decodes UPC-E and ignores the add-on code when presented with a UPC-E plus 2-digit add-on barcode. It can also decode UPC-E barcodes without 2-digit add-on codes.

**Enable 2-Digit Add-On Code:** The scanner decodes a mix of UPC-E barcodes with and without 2-digit add-on codes.



@SETUPE0  
**\*\* Exit Setup**



@SETUPE1

Enter Setup

---

## 5-Digit Add-On Code

A UPC-E barcode can be augmented with a five-digit add-on code to form a new one. In the example below, the part surrounded by blue dotted line is a UPC-E barcode while the part circled by red dotted line is a five-digit add-on code.



@UPEAD50

\*\* Disable 5-Digit Add-On Code



@UPEAD51

Enable 5-Digit Add-On Code



**Disable 5-Digit Add-On Code:** The scanner decodes UPC-E and ignores the add-on code when presented with a UPC-E plus 5-digit add-on barcode. It can also decode UPC-E barcodes without 5-digit add-on codes.

**Enable 5-Digit Add-On Code:** The scanner decodes a mix of UPC-E barcodes with and without 5-digit add-on codes.



@SETUPE0

\*\* Exit Setup



@SETUPE1

Enter Setup

---

### Add-On Code Required

When **UPC-E Add-On Code Required** is selected, the scanner will only read UPC-E barcodes that contain add-on codes.



@UPEREQ0

\*\* UPC-E Add-On Code Not Required



@UPEREQ1

UPC-E Add-On Code Required

### Transmit Preamble Character

Preamble characters (Country Code and System Character) can be transmitted as part of a UPC-E barcode. Select one of the following options for transmitting UPC-E preamble to the host device: transmit system character only, transmit system character and country code ("0" for USA), or transmit no preamble.



@UPEPRE1

System Character



@UPEPRE0

\*\* No Preamble



@UPEPRE2

System Character & Country Code

### Convert UPC-E to UPC-A

**Convert UPC-E to UPC-A:** Convert UPC-E (zero suppressed) decoded data to UPC-A format before transmission. After conversion, the data follows UPC-A format and is affected by UPC-A programming selections (e.g., Preamble, Check Character).

---



@SETUPE0

\*\* Exit Setup



@SETUPE1

**Enter Setup**

---

**Do Not Convert UPC-E to UPC-A:** UPC-E decoded data is transmitted as UPC-E data, without conversion.



@UPEEXP0

**\*\* Do Not Convert UPC-E to UPC-A**



@UPEEXP1

**Convert UPC-E to UPC-A**



@SETUPE0

**\*\* Exit Setup**



@SETUPE1  
Enter Setup

## UPC-A

### Restore Factory Defaults



@UPADEF  
Restore the Factory Defaults of UPC-A

### Enable/Disable UPC-A



@UPAENA1  
\*\* Enable UPC-A



@UPAENA0  
Disable UPC-A



If the scanner fails to identify UPC-A barcodes, you may first try this solution by scanning the **Enter Setup** barcode and then **Enable UPC-A** barcode.

### Transmit Check Character

UPC-A is 13 digits in length with the last one as its check character used to verify the integrity of the data.



@UPACHK2  
\*\* Transmit UPC-A Check Character

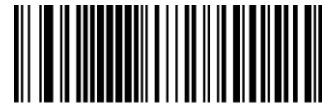

@UPACHK1  
Do Not Transmit UPC-A Check Character



@SETUPE0  
\*\* Exit Setup



@SETUPE1

Enter Setup

## 2-Digit Add-On Code

A UPC-A barcode can be augmented with a two-digit add-on code to form a new one. In the example below, the part surrounded by blue dotted line is a UPC-A barcode while the part circled by red dotted line is a two-digit add-on code.



@UPAAD20

\*\* Disable 2-Digit Add-On Code



@UPAAD21

Enable 2-Digit Add-On Code



**Disable 2-Digit Add-On Code:** The scanner decodes UPC-A and ignores the add-on code when presented with a UPC-A plus 2-digit add-on barcode. It can also decode UPC-A barcodes without 2-digit add-on codes.

**Enable 2-Digit Add-On Code:** The scanner decodes a mix of UPC-A barcodes with and without 2-digit add-on codes.



@SETUPE0

\*\* Exit Setup



@SETUPE1

Enter Setup

---

### 5-Digit Add-On Code

A UPC-A barcode can be augmented with a five-digit add-on code to form a new one. In the example below, the part surrounded by blue dotted line is a UPC-A barcode while the part circled by red dotted line is a five-digit add-on code.



@UPAAD50

\*\* Disable 5-Digit Add-On Code



@UPAAD51

Enable 5-Digit Add-On Code



**Disable 5-Digit Add-On Code:** The scanner decodes UPC-A and ignores the add-on code when presented with a UPC-A plus 5-digit add-on barcode. It can also decode UPC-A barcodes without 5-digit add-on codes.

**Enable 5-Digit Add-On Code:** The scanner decodes a mix of UPC-A barcodes with and without 5-digit add-on codes.



@SETUPE0

\*\* Exit Setup





@SETUPE1

Enter Setup

---

### Add-On Code Required

When **UPC-A Add-On Code Required** is selected, the scanner will only read UPC-A barcodes that contain add-on codes.



@UPAREQ0

**\*\* UPC-A Add-On Code Not Required**



@UPAREQ1

**UPC-A Add-On Code Required**

### Transmit Preamble Character

Preamble characters (Country Code and System Character) can be transmitted as part of a UPC-A barcode. Select one of the following options for transmitting UPC-A preamble to the host device: transmit system character only, transmit system character and country code ("0" for USA), or transmit no preamble.



@UPAPRE0

**No Preamble**



@UPAPRE1

**\*\* System Character**



@UPAPRE2

**System Character & Country Code**



@SETUPE0

**\*\* Exit Setup**



@SETUPE1  
Enter Setup

## Coupon

### UPC-A/EAN-13 with Extended Coupon Code

The following three types of coupon code + extended coupon code are supported:

- ◇ UPC-A (starting with “5”) + GS1-128
- ◇ UPC-A (starting with “5”) + GS1 Databar
- ◇ EAN-13 (starting with “99”) + GS1-128

Use the appropriate barcode below to enable or disable UPC-A/EAN-13 with Extended Coupon Code. When left on the default setting (**Off**), the scanner treats Coupon Codes and Extended Coupon Codes as single barcodes.

If you scan the **Allow Concatenation** code, when the scanner sees the coupon code and the extended coupon code in a single scan, it transmits both as separate symbologies. Otherwise, it transmits the first coupon code it reads.

If you scan the **Require Concatenation** code, the scanner must see and read the coupon code and extended coupon code in a single read to transmit the data. No data is output unless both codes are read.



@CPNENA0  
\*\* Off



@CPNENA1  
**Allow Concatenation**



@CPNENA2  
**Require Concatenation**



When using the UPC-A Coupon feature, please ensure that **System Character** or **System Character & Country Code** is selected for the “Transmit UPC-A Preamble Character” feature.



@SETUPE0  
\*\* Exit Setup



@SETUPE1

**Enter Setup**

---

### Coupon GS1 Databar Output

If you scan coupons that have both UPC and GS1 Databar codes, you may wish to scan and output only the data from the GS1 Databar code. Scan the **GS1 Output On** barcode below to scan and output only the GS1 Databar code data.

When **GS1 Output Off** is selected, coupons that have both UPC and GS1 Databar codes are transmitted depending on your selection for the “UPC-A/EAN-13 with Extended Coupon Code” feature.



@CPNGS10

**\*\* GS1 Output Off**



@CPNGS11

**GS1 Output On**



When using the UPC-A Coupon feature, please ensure that **System Character** or **System Character & Country Code** is selected for the “Transmit UPC-A Preamble Character” feature.



@SETUPE0

**\*\* Exit Setup**



@SETUPE1  
**Enter Setup**

---

## Interleaved 2 of 5

### Restore Factory Defaults



@I25DEF  
**Restore the Factory Defaults of Interleaved 2 of 5**

### Enable/Disable Interleaved 2 of 5



@I25ENA1  
**\*\* Enable Interleaved 2 of 5**



@I25ENA0  
**Disable Interleaved 2 of 5**



If the scanner fails to identify Interleaved 2 of 5 barcodes, you may first try this solution by scanning the **Enter Setup** barcode and then **Enable Interleaved 2 of 5** barcode.



@SETUPE0  
**\*\* Exit Setup**



@SETUPE1

Enter Setup

## Set Length Range for Interleaved 2 of 5

The scanner can be configured to only decode Interleaved 2 of 5 barcodes with lengths that fall between (inclusive) the minimum and maximum lengths. To accomplish it, you need to set the minimum and maximum lengths.



@I25MIN

Set the Minimum Length (Default: 6)



@I25MAX

Set the Maximum Length (Default: 80)



If minimum length is set to be greater than maximum length, the scanner only decodes Interleaved 2 of 5 barcodes with either the minimum or maximum length. If minimum length is same as maximum length, only Interleaved 2 of 5 barcodes with that length are to be decoded.



**Set the scanner to decode Interleaved 2 of 5 barcodes containing between 8 and 12 characters:**

1. Scan the **Enter Setup** barcode.
2. Scan the **Set the Minimum Length** barcode.
3. Scan the numeric barcode “8” from the “Digit Barcodes” section in Appendix.
4. Scan the **Save** barcode from the “Save/Cancel Barcodes” section in Appendix.
5. Scan the **Set the Maximum Length** barcode.
6. Scan the numeric barcodes “1” and “2” from the “Digit Barcodes” section in Appendix.
7. Scan the **Save** barcode from the “Save/Cancel Barcodes” section in Appendix.
8. Scan the **Exit Setup** barcode.



@SETUPE0

\*\* Exit Setup



@SETUPE1  
Enter Setup

## Check Character Verification

A check character is optional for Interleaved 2 of 5 and can be added as the last character. It is a calculated value used to verify the integrity of the data.

- ◇ **Disable:** The scanner transmits Interleaved 2 of 5 barcodes as is.
- ◇ **Do Not Transmit Check Character After Verification:** The scanner checks the integrity of all Interleaved 2 of 5 barcodes to verify that the data complies with the check character algorithm. Barcodes passing the check will be transmitted except the last digit, whereas those failing it will not be transmitted.
- ◇ **Transmit Check Character After Verification:** The scanner checks the integrity of all Interleaved 2 of 5 barcodes to verify that the data complies with the check character algorithm. Barcodes passing the check will be transmitted, whereas those failing it will not be transmitted.

Since Interleaved 2 of 5 must always have an even number of digits, a zero may need to be added as the first digit when the check character is added. The check character is automatically generated when making Interleaved 2 of 5 barcodes.



@I25CHK0  
**Disable**



@I25CHK1

**\*\* Do Not Transmit Check Character After Verification**



@I25CHK2

**Transmit Check Character After Verification**



If the **Do Not Transmit Check Character After Verification** option is enabled, Interleaved 2 of 5 barcodes with a length that is less than the configured minimum length after having the check character excluded will not be decoded. (For example, when the **Do Not Transmit Check Character After Verification** option is enabled and the minimum length is set to 4, Interleaved 2 of 5 barcodes with a total length of 4 characters including the check character cannot be read.)



@SETUPE0  
**\*\* Exit Setup**



@SETUPE1

Enter Setup

---

## Febraban

### Disable/Enable Febraban



@I25FBB0

Disable Febraban



@I25FBB1

\*\* Enable Febraban, Do Not Expand



@I25FBB2

Enable Febraban, Expand

### Transmit Delay per Character

**Transmit Delay per Character** applies to both Expanded and Unexpanded Febraban. This feature is available only when USB HID Keyboard is enabled.



@FEBSNO

\*\* Disable Transmit Delay per Character



@FEBSN1

Enable Transmit Delay per Character



@SETUPE1

**Enter Setup**

---

You may select an appropriate delay value from the options below as per your actual needs.



@FEBSDT0

**0ms**



@FEBSDT5

**5ms**



@FEBSDT10

**10ms**



@FEBSDT15

**15ms**



@FEBSDT20

**20ms**



@FEBSDT25

**25ms**



@FEBSDT30

**30ms**



@FEBSDT35

**35ms**



@SETUPE0

**\*\* Exit Setup**





@SETUPE1

Enter Setup

---



@FEBSDT40

**40ms**



@FEBSDT45

**45ms**



@FEBSDT50

**50ms**



@FEBSDT55

**55ms**



@FEBSDT60

**60ms**



@FEBSDT65

**65ms**



@FEBSDT70

**\*\* 70ms**



@FEBSDT75

**75ms**



@SETUPE1

**Enter Setup**

---

### Transmit Delay per 12 Characters

**Transmit Delay per 12 Characters** applies to Expanded Febraban only. This feature is available only when USB HID Keyboard is enabled.



@FEBMENO

**\*\* Disable Transmit Delay per 12 Characters**



@FEBMEN1

**Enable Transmit Delay per 12 Characters**

You may select an appropriate delay value from the options below as per your actual needs.



@FEBMDT0

**0ms**



@FEBMDT1

**300ms**



@FEBMDT2

**400ms**



@SETUPE0

**\*\* Exit Setup**



@SETUPE1

**Enter Setup**

---



@FEBMDT3

**\*\* 500ms**



@FEBMDT4

**600ms**



@FEBMDT5

**700ms**



@FEBMDT6

**800ms**



@FEBMDT7

**900ms**



@SETUPE0

**\*\* Exit Setup**



@SETUPE1

**Enter Setup**

## ITF-14

ITF-14 is a special kind of Interleaved 2 of 5 with a length of 14 characters and the last character as the check character.

ITF-14 priority principle: For the Interleaved 2 of 5 barcodes with a length of 14 characters and the last character as the check character, the ITF-14 configurations shall take precedence over the Interleaved 2 of 5 settings.

### Restore Factory Defaults



@I14DEF

**Restore the Factory Defaults of ITF-14**

### Enable/Disable ITF-14



@I14ENA0

**\*\* Disable ITF-14**



@I14ENA1

**Enable ITF-14 But Do Not Transmit Check Character**



@I14ENA2

**Enable ITF-14 and Transmit Check Character**



An example of the ITF-14 priority principle: when ITF-14 is enabled and Interleaved 2 of 5 is disabled, the scanner only decodes Interleaved 2 of 5 barcodes with a length of 14 characters and the last character as the check character.



@SETUPE0

**\*\* Exit Setup**



@SETUPE1

**Enter Setup**

## ITF-6

ITF-6 is a special kind of Interleaved 2 of 5 with a length of 6 characters and the last character as the check character.

ITF-6 priority principle: For the Interleaved 2 of 5 barcodes with a length of 6 characters and the last character as the check character, the ITF-6 configurations shall take precedence over the Interleaved 2 of 5 settings.

### Restore Factory Defaults



@IT6DEF

**Restore the Factory Defaults of ITF-6**

### Enable/Disable ITF-6



@IT6ENA0

**\*\* Disable ITF-6**



@IT6ENA1

**Enable ITF-6 But Do Not Transmit Check Character**



@IT6ENA2

**Enable ITF-6 and Transmit Check Character**



An example of the ITF-6 priority principle: when ITF-6 is enabled and Interleaved 2 of 5 is disabled, the scanner only decodes Interleaved 2 of 5 barcodes with a length of 6 characters and the last character as the check character.



@SETUPE0

**\*\* Exit Setup**



@SETUPE1

**Enter Setup**

---

## Matrix 2 of 5

### Restore Factory Defaults



@M25DEF

**Restore the Factory Defaults of Matrix 2 of 5**

### Enable/Disable Matrix 2 of 5



@M25ENA1

**\*\* Enable Matrix 2 of 5**



@M25ENA0

**Disable Matrix 2 of 5**



If the scanner fails to identify Matrix 2 of 5 barcodes, you may first try this solution by scanning the **Enter Setup** barcode and then **Enable Matrix 2 of 5** barcode.



@SETUPE0

**\*\* Exit Setup**



@SETUPE1

**Enter Setup**

---

## Set Length Range for Matrix 2 of 5

The scanner can be configured to only decode Matrix 2 of 5 barcodes with lengths that fall between (inclusive) the minimum and maximum lengths. To accomplish it, you need to set the minimum and maximum lengths.



@M25MIN

**Set the Minimum Length (Default: 4)**



@M25MAX

**Set the Maximum Length (Default: 80)**



If minimum length is set to be greater than maximum length, the scanner only decodes Matrix 2 of 5 barcodes with either the minimum or maximum length. If minimum length is same as maximum length, only Matrix 2 of 5 barcodes with that length are to be decoded.



**Set the scanner to decode Matrix 2 of 5 barcodes containing between 8 and 12 characters:**

1. Scan the **Enter Setup** barcode.
2. Scan the **Set the Minimum Length** barcode.
3. Scan the numeric barcode “8” from the “Digit Barcodes” section in Appendix.
4. Scan the **Save** barcode from the “Save/Cancel Barcodes” section in Appendix.
5. Scan the **Set the Maximum Length** barcode.
6. Scan the numeric barcodes “1” and “2” from the “Digit Barcodes” section in Appendix.
7. Scan the **Save** barcode from the “Save/Cancel Barcodes” section in Appendix.
8. Scan the **Exit Setup** barcode.



@SETUPE0

**\*\* Exit Setup**



@SETUPE1  
Enter Setup

## Check Character Verification

A check character is optional for Matrix 2 of 5 and can be added as the last character. It is a calculated value used to verify the integrity of the data.

- ◇ **Disable:** The scanner transmits Matrix 2 of 5 barcodes as is.
- ◇ **Do Not Transmit Check Character After Verification:** The scanner checks the integrity of all Matrix 2 of 5 barcodes to verify that the data complies with the check character algorithm. Barcodes passing the check will be transmitted except the last digit, whereas those failing it will not be transmitted.
- ◇ **Transmit Check Character After Verification:** The scanner checks the integrity of all Matrix 2 of 5 barcodes to verify that the data complies with the check character algorithm. Barcodes passing the check will be transmitted, whereas those failing it will not be transmitted.

Since Matrix 2 of 5 must always have an even number of digits, a zero may need to be added as the first digit when the check character is added. The check character is automatically generated when making Matrix 2 of 5 barcodes.



@M25CHK0  
\*\* Disable



@M25CHK1

**Do Not Transmit Check Character After Verification**



@M25CHK2

**Transmit Check Character After Verification**



If the **Do Not Transmit Check Character After Verification** option is enabled, Matrix 2 of 5 barcodes with a length that is less than the configured minimum length after having the check character excluded will not be decoded. (For example, when the **Do Not Transmit Check Character After Verification** option is enabled and the minimum length is set to 4, Matrix 2 of 5 barcodes with a total length of 4 characters including the check character cannot be read.)



@SETUPE0  
\*\* Exit Setup





@SETUPE1

**Enter Setup**

---

## Code 39

### Restore Factory Defaults



@C39DEF

**Restore the Factory Defaults of Code 39**

### Enable/Disable Code 39



@C39ENA1

**\*\* Enable Code 39**



@C39ENA0

**Disable Code 39**



If the scanner fails to identify Code 39 barcodes, you may first try this solution by scanning the **Enter Setup** barcode and then **Enable Code 39** barcode.



@SETUPE0

**\*\* Exit Setup**



@SETUPE1  
Enter Setup

## Set Length Range for Code 39

The scanner can be configured to only decode Code 39 barcodes with lengths that fall between (inclusive) the minimum and maximum lengths. To accomplish it, you need to set the minimum and maximum lengths.



@C39MIN  
Set the Minimum Length (Default: 1)



@C39MAX  
Set the Maximum Length (Default: 48)



If minimum length is set to be greater than maximum length, the scanner only decodes Code 39 barcodes with either the minimum or maximum length. If minimum length is same as maximum length, only Code 39 barcodes with that length are to be decoded.

## Example

**Set the scanner to decode Code 39 barcodes containing between 8 and 12 characters:**

1. Scan the **Enter Setup** barcode.
2. Scan the **Set the Minimum Length** barcode.
3. Scan the numeric barcode “8” from the “Digit Barcodes” section in Appendix.
4. Scan the **Save** barcode from the “Save/Cancel Barcodes” section in Appendix.
5. Scan the **Set the Maximum Length** barcode.
6. Scan the numeric barcodes “1” and “2” from the “Digit Barcodes” section in Appendix.
7. Scan the **Save** barcode from the “Save/Cancel Barcodes” section in Appendix.
8. Scan the **Exit Setup** barcode.



@SETUPE0  
\*\* Exit Setup



@SETUPE1

Enter Setup

## Check Character Verification

A check character is optional for Code 39 and can be added as the last character. It is a calculated value used to verify the integrity of the data.

- ◇ **Disable:** The scanner transmits Code 39 barcodes as is.
- ◇ **Do Not Transmit Check Character After Verification:** The scanner checks the integrity of all Code 39 barcodes to verify that the data complies with the check character algorithm. Barcodes passing the check will be transmitted except the last digit, whereas those failing it will not be transmitted.
- ◇ **Transmit Check Character After Verification:** The scanner checks the integrity of all Code 39 barcodes to verify that the data complies with the check character algorithm. Barcodes passing the check will be transmitted, whereas those failing it will not be transmitted.



@C39CHK0

\*\* Disable



@C39CHK1

Do Not Transmit Check Character After Verification



@C39CHK2

Transmit Check Character After Verification



If the **Do Not Transmit Check Character After Verification** option is enabled, Code 39 barcodes with a length that is less than the configured minimum length after having the check character excluded will not be decoded. (For example, when the **Do Not Transmit Check Character After Verification** option is enabled and the minimum length is set to 4, Code 39 barcodes with a total length of 4 characters including the check character cannot be read.)



@SETUPE0

\*\* Exit Setup



@SETUPE1

**Enter Setup**

---

### **Transmit Start/Stop Character**

Code 39 uses an asterisk (\*) for both the start and the stop characters. You can choose whether or not to transmit the start/stop characters by scanning the appropriate barcode below.



@C39TSC0

**\*\* Do Not Transmit Start/Stop Character**



@C39TSC1

**Transmit Start/Stop Character**

### **Enable/Disable Code 39 Full ASCII**

The scanner can be configured to identify all ASCII characters by scanning the appropriate barcode below.



@C39ASC0

**\*\* Disable Code 39 Full ASCII**



@C39ASC1

**Enable Code 39 Full ASCII**



@SETUPE0

**\*\* Exit Setup**



@SETUPE1

**Enter Setup**

---

### **Enable/Disable Code 32 (Italian Pharma Code)**

Code 32 is a variant of Code 39 used by the Italian pharmaceutical industry. Scan the appropriate barcode below to enable or disable Code 32. Code 39 must be enabled and Code 39 check character verification must be disabled for this parameter to function.



@C39E320

**\*\* Disable Code 32**



@C39E321

**Enable Code 32**

### **Code 32 Prefix**

You may scan the appropriate barcode below to enable or disable adding the prefix character "A" to all Code 32 barcodes. Code 32 must be enabled for this parameter to function.



@C39S320

**\*\* Disable Code 32 Prefix**



@C39S321

**Enable Code 32 Prefix**



@SETUPE0

**\*\* Exit Setup**



@SETUPE1

**Enter Setup**

---

### **Transmit Code 32 Start/Stop Character**

Code 32 must be enabled for this parameter to function.



@C39T320

**\*\* Do Not Transmit Code 32 Start/Stop Character**



@C39T321

**Transmit Code 32 Start/Stop Character**

### **Transmit Code 32 Check Character**

Code 32 must be enabled for this parameter to function.



@C39C320

**\*\* Do Not Transmit Code 32 Check Character**



@C39C321

**Transmit Code 32 Check Character**



@SETUPE0

**\*\* Exit Setup**



@SETUPE1

**Enter Setup**

---

## Codabar

### Restore Factory Defaults



@CBADEF

**Restore the Factory Defaults of Codabar**

### Enable/Disable Codabar



@CBAENA1

**\*\* Enable Codabar**



@CBAENA0

**Disable Codabar**



If the scanner fails to identify Codabar barcodes, you may first try this solution by scanning the **Enter Setup** barcode and then **Enable Codabar** barcode.



@SETUPE0

**\*\* Exit Setup**



@SETUPE1  
Enter Setup

## Set Length Range for Codabar

The scanner can be configured to only decode Codabar barcodes with lengths that fall between (inclusive) the minimum and maximum lengths. To accomplish it, you need to set the minimum and maximum lengths.



**Set the Minimum Length (Default: 2)**



**Set the Maximum Length (Default: 60)**



If minimum length is set to be greater than maximum length, the scanner only decodes Codabar barcodes with either the minimum or maximum length. If minimum length is same as maximum length, only Codabar barcodes with that length are to be decoded.

**E**  
*sample*

**Set the scanner to decode Codabar barcodes containing between 8 and 12 characters:**

1. Scan the **Enter Setup** barcode.
2. Scan the **Set the Minimum Length** barcode.
3. Scan the numeric barcode “8” from the “Digit Barcodes” section in Appendix.
4. Scan the **Save** barcode from the “Save/Cancel Barcodes” section in Appendix.
5. Scan the **Set the Maximum Length** barcode.
6. Scan the numeric barcodes “1” and “2” from the “Digit Barcodes” section in Appendix.
7. Scan the **Save** barcode from the “Save/Cancel Barcodes” section in Appendix.
8. Scan the **Exit Setup** barcode.



@SETUPE0  
**\*\* Exit Setup**





@SETUPE1

Enter Setup

## Check Character Verification

A check character is optional for Codabar and can be added as the last character. It is a calculated value used to verify the integrity of the data.

- ◇ **Disable:** The scanner transmits Codabar barcodes as is.
- ◇ **Do Not Transmit Check Character After Verification:** The scanner checks the integrity of all Codabar barcodes to verify that the data complies with the check character algorithm. Barcodes passing the check will be transmitted except the last digit, whereas those failing it will not be transmitted.
- ◇ **Transmit Check Character After Verification:** The scanner checks the integrity of all Codabar barcodes to verify that the data complies with the check character algorithm. Barcodes passing the check will be transmitted, whereas those failing it will not be transmitted.



@CBACHK0

\*\* Disable



@CBACHK1

Do Not Transmit Check Character After Verification



@CBACHK2

Transmit Check Character After Verification



If the **Do Not Transmit Check Character After Verification** option is enabled, Codabar barcodes with a length that is less than the configured minimum length after having the check character excluded will not be decoded. (For example, when the **Do Not Transmit Check Character After Verification** option is enabled and the minimum length is set to 4, Codabar barcodes with a total length of 4 characters including the check character cannot be read.)



@SETUPE0

\*\* Exit Setup



@SETUPE1

**Enter Setup**

---

### Start/Stop Character

You can set the start/stop characters and choose whether or not to transmit the start/stop characters by scanning the appropriate barcode below.



@CBATSC0

**\*\* Do Not Transmit Start/Stop Character**



@CBATSC1

**Transmit Start/Stop Character**



@CBASCF0

**\*\* ABCD/ABCD as the Start/Stop Character**



@CBASCF1

**ABCD/TN\*E as the Start/Stop Character**



@CBASCF2

**abcd/abcd as the Start/Stop Character**



@CBASCF3

**abcd/tn\*e as the Start/Stop Character**



@SETUPE0

**\*\* Exit Setup**



@SETUPE1

**Enter Setup**

---

## Code 93

### Restore Factory Defaults



@C93DEF

**Restore the Factory Defaults of Code 93**

### Enable/Disable Code 93



@C93ENA1

**\*\* Enable Code 93**



@C93ENA0

**Disable Code 93**



If the scanner fails to identify Code 93 barcodes, you may first try this solution by scanning the **Enter Setup** barcode and then **Enable Code 93** barcode.



@SETUPE0

**\*\* Exit Setup**



@SETUPE1  
Enter Setup

## Set Length Range for Code 93

The scanner can be configured to only decode Code 93 barcodes with lengths that fall between (inclusive) the minimum and maximum lengths. To accomplish it, you need to set the minimum and maximum lengths.



Set the Minimum Length (Default: 1)



Set the Maximum Length (Default: 48)



If minimum length is set to be greater than maximum length, the scanner only decodes Code 93 barcodes with either the minimum or maximum length. If minimum length is same as maximum length, only Code 93 barcodes with that length are to be decoded.

**Set the scanner to decode Code 93 barcodes containing between 8 and 12 characters:**

**E**  
*xample*

1. Scan the **Enter Setup** barcode.
2. Scan the **Set the Minimum Length** barcode.
3. Scan the numeric barcode “8” from the “Digit Barcodes” section in Appendix.
4. Scan the **Save** barcode from the “Save/Cancel Barcodes” section in Appendix.
5. Scan the **Set the Maximum Length** barcode.
6. Scan the numeric barcodes “1” and “2” from the “Digit Barcodes” section in Appendix.
7. Scan the **Save** barcode from the “Save/Cancel Barcodes” section in Appendix.
8. Scan the **Exit Setup** barcode.



@SETUPE0  
\*\* Exit Setup



@SETUPE1

Enter Setup

## Check Character Verification

Check characters are optional for Code 93 and can be added as the last two characters, which are calculated values used to verify the integrity of the data.

- ◇ **Disable:** The scanner transmits Code 93 barcodes as is.
- ◇ **Do Not Transmit Check Character After Verification:** The scanner checks the integrity of all Code 93 barcodes to verify that the data complies with the check character algorithm. Barcodes passing the checks will be transmitted except the last two digits, whereas those failing them will not be transmitted.
- ◇ **Transmit Check Character After Verification:** The scanner checks the integrity of all Code 93 barcodes to verify that the data complies with the check character algorithm. Barcodes passing the checks will be transmitted, whereas those failing them will not be transmitted.



@C93CHK0

Disable



@C93CHK1

**\*\* Do Not Transmit Check Character After Verification**



@C93CHK2

**Transmit Check Character After Verification**



If the **Do Not Transmit Check Character After Verification** option is enabled, Code 93 barcodes with a length that is less than the configured minimum length after having the two check characters excluded will not be decoded. (For example, when the **Do Not Transmit Check Character After Verification** option is enabled and the minimum length is set to 4, Code 93 barcodes with a total length of 4 characters including the two check characters cannot be read.)



@SETUPE0

**\*\* Exit Setup**



@SETUPE1

**Enter Setup**

---

## China Post 25

### Restore Factory Defaults



@CHPDEF

**Restore the Factory Defaults of China Post 25**

### Enable/Disable China Post 25



@CHPENA1

**Enable China Post 25**



@CHPENA0

**\*\* Disable China Post 25**



If the scanner fails to identify China Post 25 barcodes, you may first try this solution by scanning the **Enter Setup** barcode and then **Enable China Post 25** barcode.



@SETUPE0

**\*\* Exit Setup**



@SETUPE1

**Enter Setup**

---

## Set Length Range for China Post 25

The scanner can be configured to only decode China Post 25 barcodes with lengths that fall between (inclusive) the minimum and maximum lengths. To accomplish it, you need to set the minimum and maximum lengths.



@CHPMIN

**Set the Minimum Length (Default: 1)**



@CHPMAX

**Set the Maximum Length (Default: 48)**



If minimum length is set to be greater than maximum length, the scanner only decodes China Post 25 barcodes with either the minimum or maximum length. If minimum length is same as maximum length, only China Post 25 barcodes with that length are to be decoded.



**Set the scanner to decode China Post 25 barcodes containing between 8 and 12 characters:**

1. Scan the **Enter Setup** barcode.
2. Scan the **Set the Minimum Length** barcode.
3. Scan the numeric barcode “8” from the “Digit Barcodes” section in Appendix.
4. Scan the **Save** barcode from the “Save/Cancel Barcodes” section in Appendix.
5. Scan the **Set the Maximum Length** barcode.
6. Scan the numeric barcodes “1” and “2” from the “Digit Barcodes” section in Appendix.
7. Scan the **Save** barcode from the “Save/Cancel Barcodes” section in Appendix.
8. Scan the **Exit Setup** barcode.



@SETUPE0

**\*\* Exit Setup**



@SETUPE1  
Enter Setup

## Check Character Verification

A check character is optional for China Post 25 and can be added as the last character. It is a calculated value used to verify the integrity of the data.

- ◇ **Disable:** The scanner transmits China Post 25 barcodes as is.
- ◇ **Do Not Transmit Check Character After Verification:** The scanner checks the integrity of all China Post 25 barcodes to verify that the data complies with the check character algorithm. Barcodes passing the check will be transmitted except the last digit, whereas those failing it will not be transmitted.
- ◇ **Transmit Check Character After Verification:** The scanner checks the integrity of all China Post 25 barcodes to verify that the data complies with the check character algorithm. Barcodes passing the check will be transmitted, whereas those failing it will not be transmitted.



@CHPCHK0  
\*\* Disable



@CHPCHK1

**Do Not Transmit Check Character After Verification**



@CHPCHK2

**Transmit Check Character After Verification**



If the **Do Not Transmit Check Character After Verification** option is enabled, China Post 25 barcodes with a length that is less than the configured minimum length after having the check character excluded will not be decoded. (For example, when the **Do Not Transmit Check Character After Verification** option is enabled and the minimum length is set to 4, China Post 25 barcodes with a total length of 4 characters including the check character cannot be read.)



@SETUPE0  
\*\* Exit Setup





@SETUPE1

**Enter Setup**

---

## GS1-128 (UCC/EAN-128)

### Restore Factory Defaults



@GS1DEF

**Restore the Factory Defaults of GS1-128**

### Enable/Disable GS1-128



@GS1ENA1

**\*\* Enable GS1-128**



@GS1ENA0

**Disable GS1-128**



If the scanner fails to identify GS1-128 barcodes, you may first try this solution by scanning the **EnterSetup** barcode and then **Enable GS1-128** barcode.



@SETUPE0

**\*\* Exit Setup**



@SETUPE1  
**Enter Setup**

## Set Length Range for GS1-128

The scanner can be configured to only decode GS1-128 barcodes with lengths that fall between (inclusive) the minimum and maximum lengths. To accomplish it, you need to set the minimum and maximum lengths.



**Set the Minimum Length (Default: 1)**



**Set the Maximum Length (Default: 48)**



If minimum length is set to be greater than maximum length, the scanner only decodes GS1-128 barcodes with either the minimum or maximum length. If minimum length is same as maximum length, only GS1-128 barcodes with that length are to be decoded.

## **E** *sample*

Set the scanner to decode GS1-128 barcodes containing between 8 and 12 characters:

1. Scan the **Enter Setup** barcode.
2. Scan the **Set the Minimum Length** barcode.
3. Scan the numeric barcode “8” from the “Digit Barcodes” section in Appendix.
4. Scan the **Save** barcode from the “Save/Cancel Barcodes” section in Appendix.
5. Scan the **Set the Maximum Length** barcode.
6. Scan the numeric barcodes “1” and “2” from the “Digit Barcodes” section in Appendix.
7. Scan the **Save** barcode from the “Save/Cancel Barcodes” section in Appendix.
8. Scan the **Exit Setup** barcode.



@SETUPE0  
**\*\* Exit Setup**



@SETUPE1

**Enter Setup**

## GS1 Databar (RSS)

### Restore Factory Defaults



@RSSDEF

**Restore the Factory Defaults of GS1 Databar**

### Enable/Disable GS1 Databar



@RSSENA1

**\*\* Enable GS1 Databar**



@RSSENA0

**Disable GS1 Databar**



If the scanner fails to identify GS1 Databar barcodes, you may first try this solution by scanning the **Enter Setup** barcode and then **Enable GS1 Databar** barcode.

### Transmit Application Identifier "01"



@RSSTA1

**\*\* Transmit Application Identifier "01"**



@RSSTA0

**Do Not Transmit Application Identifier "01"**



@SETUPE0

**\*\* Exit Setup**



@SETUPE1  
Enter Setup

## GS1 Composite (EAN-UCC Composite)

### Restore Factory Defaults



@CPTDEF  
Restore the Factory Defaults of GS1 Composite

### Enable/Disable GS1 Composite



@CPTENA1  
Enable GS1 Composite



@CPTENA0  
\*\* Disable GS1 Composite



If the scanner fails to identify GS1 Composite barcodes, you may first try this solution by scanning the **Enter Setup** barcode and then **Enable GS1 Composite** barcode.

### Enable/Disable UPC/EAN Composite



@CPTUPC1  
Enable UPC/EAN Composite

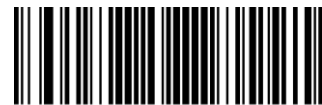

@CPTUPC0  
\*\* Disable UPC/EAN Composite



@SETUPE0  
\*\* Exit Setup



@SETUPE1  
**Enter Setup**

---

## Code 11

### Restore Factory Defaults



@C11DEF

**Restore the Factory Defaults of Code 11**

### Enable/Disable Code 11



@C11ENA1

**\*\* Enable Code 11**



@C11ENA0

**Disable Code 11**



If the scanner fails to identify Code 11 barcodes, you may first try this solution by scanning the **Enter Setup** barcode and then **Enable Code 11** barcode.



@SETUPE0

**\*\* Exit Setup**



@SETUPE1  
**Enter Setup**

## Set Length Range for Code 11

The scanner can be configured to only decode Code 11 barcodes with lengths that fall between (inclusive) the minimum and maximum lengths. To accomplish it, you need to set the minimum and maximum lengths.



@C11MIN

**Set the Minimum Length (Default: 4)**



@C11MAX

**Set the Maximum Length (Default: 48)**



If minimum length is set to be greater than maximum length, the scanner only decodes Code 11 barcodes with either the minimum or maximum length. If minimum length is same as maximum length, only Code 11 barcodes with that length are to be decoded.



**Set the scanner to decode Code 11 barcodes containing between 8 and 12 characters:**

1. Scan the **Enter Setup** barcode.
2. Scan the **Set the Minimum Length** barcode.
3. Scan the numeric barcode “8” from the “Digit Barcodes” section in Appendix.
4. Scan the **Save** barcode from the “Save/Cancel Barcodes” section in Appendix.
5. Scan the **Set the Maximum Length** barcode.
6. Scan the numeric barcodes “1” and “2” from the “Digit Barcodes” section in Appendix.
7. Scan the **Save** barcode from the “Save/Cancel Barcodes” section in Appendix.
8. Scan the **Exit Setup** barcode.



@SETUPE0  
**\*\* Exit Setup**



@SETUPE1

Enter Setup

## Check Character Verification

Check characters are optional for Code 11 and can be added as the last one or two characters, which are calculated values used to verify the integrity of the data.

If the **Disable** option is enabled, the scanner transmits Code 11 barcodes as is.



@C11CHK0

Disable



@C11CHK1

\*\* One Check Character, MOD11



@C11CHK2

Two Check Characters, MOD11/MOD11



@C11CHK3

Two Check Characters, MOD11/MOD9



@C11CHK4

One Check Character, MOD11 (Len<=10)

Two Check Characters, MOD11/MOD11(Len>10)



@C11CHK5

One Check Character, MOD11 (Len<=10)

Two Check Characters, MOD11/MOD9 (Len>10)



@SETUPE0

\*\* Exit Setup



@SETUPE1

Enter Setup

---

### Transmit Check Character



@C11TCK0

Do Not Transmit Code 11 Check Character



@C11TCK1

\*\* Transmit Code 11 Check Character



If you select a check character algorithm and the **Do Not Transmit Check Character** option, Code 11 barcodes with a length that is less than the configured minimum length after having the check character(s) excluded will not be decoded. (For example, when the **One Check Character, MOD11** and **Do Not Transmit Check Character** options are enabled and the minimum length is set to 4, Code 11 barcodes with a total length of 4 characters including the check character cannot be read.)



@SETUPE0

\*\* Exit Setup





@SETUPE1

**Enter Setup**

---

## ISBN

### Restore Factory Defaults



@ISBDEF

**Restore the Factory Defaults of ISBN**

### Enable/Disable ISBN



@ISBENA1

**Enable ISBN**



@ISBENA0

**\*\* Disable ISBN**



If the scanner fails to identify ISBN barcodes, you may first try this solution by scanning the **Enter Setup** barcode and then **Enable ISBN** barcode.



@SETUPE0

**\*\* Exit Setup**



@SETUPE1

**Enter Setup**

---

### Set ISBN Format



@ISBT101

**\*\* ISBN-10**



@ISBT100

**ISBN-13**



@SETUPE0

**\*\* Exit Setup**



@SETUPE1

**Enter Setup**

---

## ISSN

### Restore Factory Defaults



@ISSDEF

**Restore the Factory Defaults of ISSN**

### Enable/Disable ISSN



@ISSENA1

**Enable ISSN**



@ISSENA0

**\*\* Disable ISSN**



If the scanner fails to identify ISSN barcodes, you may first try this solution by scanning the **Enter Setup** barcode and then **Enable ISSN** barcode.



@SETUPE0

**\*\* Exit Setup**



@SETUPE1

**Enter Setup**

---

## Industrial 25

### Restore Factory Defaults



@L25DEF

**Restore the Factory Defaults of Industrial 25**

### Enable/Disable Industrial 25



@L25ENA1

**\*\* Enable Industrial 25**



@L25ENA0

**Disable Industrial 25**



If the scanner fails to identify Industrial 25 barcodes, you may first try this solution by scanning the **Enter Setup** barcode and then **Enable Industrial 25** barcode.



@SETUPE0

**\*\* Exit Setup**



@SETUPE1

Enter Setup

## Set Length Range for Industrial 25

The scanner can be configured to only decode Industrial 25 barcodes with lengths that fall between (inclusive) the minimum and maximum lengths. To accomplish it, you need to set the minimum and maximum lengths.



@L25MIN

Set the Minimum Length (Default: 6)



@L25MAX

Set the Maximum Length (Default: 48)



If minimum length is set to be greater than maximum length, the scanner only decodes Industrial 25 barcodes with either the minimum or maximum length. If minimum length is same as maximum length, only Industrial 25 barcodes with that length are to be decoded.

## Example

**Set the scanner to decode Industrial 25 barcodes containing between 8 and 12 characters:**

1. Scan the **Enter Setup** barcode.
2. Scan the **Set the Minimum Length** barcode.
3. Scan the numeric barcode “8” from the “Digit Barcodes” section in Appendix.
4. Scan the **Save** barcode from the “Save/Cancel Barcodes” section in Appendix.
5. Scan the **Set the Maximum Length** barcode.
6. Scan the numeric barcodes “1” and “2” from the “Digit Barcodes” section in Appendix.
7. Scan the **Save** barcode from the “Save/Cancel Barcodes” section in Appendix.
8. Scan the **Exit Setup** barcode.



@SETUPE0

\*\* Exit Setup



@SETUPE1  
Enter Setup

## Check Character Verification

A check character is optional for Industrial 25 and can be added as the last character. It is a calculated value used to verify the integrity of the data.

- ◇ **Disable:** The scanner transmits Industrial 25 barcodes as is.
- ◇ **Do Not Transmit Check Character After Verification:** The scanner checks the integrity of all Industrial 25 barcodes to verify that the data complies with the check character algorithm. Barcodes passing the check will be transmitted except the last digit, whereas those failing it will not be transmitted.
- ◇ **Transmit Check Character After Verification:** The scanner checks the integrity of all Industrial 25 barcodes to verify that the data complies with the check character algorithm. Barcodes passing the check will be transmitted, whereas those failing it will not be transmitted.



@L25CHK0  
\*\* Disable



Do Not Transmit Check Character After Verification



Transmit Check Character After Verification



If the **Do Not Transmit Check Character After Verification** option is enabled, Industrial 25 barcodes with a length that is less than the configured minimum length after having the check character excluded will not be decoded. (For example, when the **Do Not Transmit Check Character After Verification** option is enabled and the minimum length is set to 4, Industrial 25 barcodes with a total length of 4 characters including the check character cannot be read.)



@SETUPE0  
\*\* Exit Setup



@SETUPE1

**Enter Setup**

---

## Standard 25

### Restore Factory Defaults



@S25DEF

**Restore the Factory Defaults of Standard 25**

### Enable/Disable Standard 25



@S25ENA1

**\*\* Enable Standard 25**



@S25ENA0

**Disable Standard 25**



If the scanner fails to identify Standard 25 barcodes, you may first try this solution by scanning the **Enter Setup** barcode and then **Enable Standard 25** barcode.



@SETUPE0

**\*\* Exit Setup**



@SETUPE1  
**Enter Setup**

## Set Length Range for Standard 25

The scanner can be configured to only decode Standard 25 barcodes with lengths that fall between (inclusive) the minimum and maximum lengths. To accomplish it, you need to set the minimum and maximum lengths.



@S25MIN  
**Set the Minimum Length (Default: 6)**



@S25MAX  
**Set the Maximum Length (Default: 48)**



If minimum length is set to be greater than maximum length, the scanner only decodes Standard 25 barcodes with either the minimum or maximum length. If minimum length is same as maximum length, only Standard 25 barcodes with that length are to be decoded.



**Set the scanner to decode Standard 25 barcodes containing between 8 and 12 characters:**

1. Scan the **Enter Setup** barcode.
2. Scan the **Set the Minimum Length** barcode.
3. Scan the numeric barcode “8” from the “Digit Barcodes” section in Appendix.
4. Scan the **Save** barcode from the “Save/Cancel Barcodes” section in Appendix.
5. Scan the **Set the Maximum Length** barcode.
6. Scan the numeric barcodes “1” and “2” from the “Digit Barcodes” section in Appendix.
7. Scan the **Save** barcode from the “Save/Cancel Barcodes” section in Appendix.
8. Scan the **Exit Setup** barcode.



@SETUPE0  
**\*\* Exit Setup**





@SETUPE1

Enter Setup

## Check Character Verification

A check character is optional for Standard 25 and can be added as the last character. It is a calculated value used to verify the integrity of the data.

- ◇ **Disable:** The scanner transmits Standard 25 barcodes as is.
- ◇ **Do Not Transmit Check Character After Verification:** The scanner checks the integrity of all Standard 25 barcodes to verify that the data complies with the check character algorithm. Barcodes passing the check will be transmitted except the last digit, whereas those failing it will not be transmitted.
- ◇ **Transmit Check Character After Verification:** The scanner checks the integrity of all Standard 25 barcodes to verify that the data complies with the check character algorithm. Barcodes passing the check will be transmitted, whereas those failing it will not be transmitted.



@S25CHK0

\*\* Disable



@S25CHK1

Do Not Transmit Check Character After Verification



@S25CHK2

Transmit Check Character After Verification



If the **Do Not Transmit Check Character After Verification** option is enabled, Standard 25 barcodes with a length that is less than the configured minimum length after having the check character excluded will not be decoded. (For example, when the **Do Not Transmit Check Character After Verification** option is enabled and the minimum length is set to 4, Standard 25 barcodes with a total length of 4 characters including the check character cannot be read.)



@SETUPE0

\*\* Exit Setup



@SETUPE1

**Enter Setup**

---

## Plessey

### Restore Factory Defaults



@PLYDEF

**Restore the Factory Defaults of Plessey**

### Enable/Disable Plessey



@PLYENA1

**Enable Plessey**



@PLYENA0

**\*\* Disable Plessey**



If the scanner fails to identify Plessey barcodes, you may first try this solution by scanning the **Enter Setup** barcode and then **Enable Plessey** barcode.



@SETUPE0

**\*\* Exit Setup**



@SETUPE1

Enter Setup

---

## Set Length Range for Plessey

The scanner can be configured to only decode Plessey barcodes with lengths that fall between (inclusive) the minimum and maximum lengths. To accomplish it, you need to set the minimum and maximum lengths.



@PLYMIN

Set the Minimum Length (Default: 48)



@PLYMAX

Set the Maximum Length (Default: 4)



If minimum length is set to be greater than maximum length, the scanner only decodes Plessey barcodes with either the minimum or maximum length. If minimum length is same as maximum length, only Plessey barcodes with that length are to be decoded.

**Set the scanner to decode Plessey barcodes containing between 8 and 12 characters:**

**E**  
*xample*

1. Scan the **Enter Setup** barcode.
2. Scan the **Set the Minimum Length** barcode.
3. Scan the numeric barcode “8” from the “Digit Barcodes” section in Appendix.
4. Scan the **Save** barcode from the “Save/Cancel Barcodes” section in Appendix.
5. Scan the **Set the Maximum Length** barcode.
6. Scan the numeric barcodes “1” and “2” from the “Digit Barcodes” section in Appendix.
7. Scan the **Save** barcode from the “Save/Cancel Barcodes” section in Appendix.
8. Scan the **Exit Setup** barcode.



@SETUPE0

\*\* Exit Setup



@SETUPE1

Enter Setup

## Check Character Verification

Check characters are optional for Plessey and can be added as the last two characters, which are calculated values used to verify the integrity of the data.

- ◇ **Disable:** The scanner transmits Plessey barcodes as is.
- ◇ **Do Not Transmit Check Character After Verification:** The scanner checks the integrity of all Plessey barcodes to verify that the data complies with the check character algorithm. Barcodes passing the checks will be transmitted except the last two digits, whereas those failing them will not be transmitted.
- ◇ **Transmit Check Character After Verification:** The scanner checks the integrity of all Plessey barcodes to verify that the data complies with the check character algorithm. Barcodes passing the checks will be transmitted, whereas those failing them will not be transmitted.



@PLYCHK0

\*\* Disable



@PLYCHK1

Do Not Transmit Check Character After Verification



@PLYCHK2

Transmit Check Character After Verification



If the **Do Not Transmit Check Character After Verification** option is enabled, Plessey barcodes with a length that is less than the configured minimum length after having the check characters excluded will not be decoded. (For example, when the **Do Not Transmit Check Character After Verification** option is enabled and the minimum length is set to 4, Plessey barcodes with a total length of 4 characters including the check characters cannot be read.)



@SETUPE0

\*\* Exit Setup



@SETUPE1  
**Enter Setup**

---

## MSI-Plessey

### Restore Factory Defaults



@MSIDF

**Restore the Factory Defaults of MSI-Plessey**

### Enable/Disable MSI-Plessey



@MSIENA1

**Enable MSI-Plessey**



@MSIENA0

**\*\* Disable MSI-Plessey**



If the scanner fails to identify MSI-Plessey barcodes, you may first try this solution by scanning the **Enter Setup** barcode and then **Enable MSI-Plessey** barcode.



@SETUPE0

**\*\* Exit Setup**



@SETUPE1  
**Enter Setup**

## Set Length Range for MSI-Plessey

The scanner can be configured to only decode MSI-Plessey barcodes with lengths that fall between (inclusive) the minimum and maximum lengths. To accomplish it, you need to set the minimum and maximum lengths.



**Set the Minimum Length (Default: 4)**



**Set the Maximum Length (Default: 48)**



If minimum length is set to be greater than maximum length, the scanner only decodes MSI-Plessey barcodes with either the minimum or maximum length. If minimum length is same as maximum length, only MSI-Plessey barcodes with that length are to be decoded.



**Set the scanner to decode MSI-Plessey barcodes containing between 8 and 12 characters:**

1. Scan the **Enter Setup** barcode.
2. Scan the **Set the Minimum Length** barcode.
3. Scan the numeric barcode “8” from the “Digit Barcodes” section in Appendix.
4. Scan the **Save** barcode from the “Save/Cancel Barcodes” section in Appendix.
5. Scan the **Set the Maximum Length** barcode.
6. Scan the numeric barcodes “1” and “2” from the “Digit Barcodes” section in Appendix.
7. Scan the **Save** barcode from the “Save/Cancel Barcodes” section in Appendix.
8. Scan the **Exit Setup** barcode.



@SETUPE0  
**\*\* Exit Setup**



@SETUPE1

Enter Setup

---

## Check Character Verification

Check characters are optional for MSI-Plessey and can be added as the last one or two characters, which are calculated values used to verify the integrity of the data.

If the **Disable** option is enabled, the scanner transmits MSI-Plessey barcodes as is.



@MSICLK0

**Disable**



@MSICLK1

**\*\* One Check Character, MOD10**



@MSICLK2

**Two Check Characters, MOD10/MOD10**



@MSICLK3

**Two Check Characters, MOD10/MOD11**



@SETUPE0

**\*\* Exit Setup**



@SETUPE1

Enter Setup

---

### Transmit Check Character



@MSITCK1

\*\* Transmit MSI-Plessey Check Character



@MSITCK0

Do Not Transmit MSI-Plessey Check Character



If you select a check character algorithm and the **Do Not Transmit Check Character** option, MSI-Plessey barcodes with a length that is less than the configured minimum length after having the check character(s) excluded will not be decoded. (For example, when the **One Check Character, MOD10** and **Do Not Transmit Check Character** options are enabled and the minimum length is set to 4, MSI-Plessey barcodes with a total length of 4 characters including the check character cannot be read.)



@SETUPE0

\*\* Exit Setup





@SETUPE1

**Enter Setup**

---

## AIM 128

### Restore Factory Defaults



@AIMDEF

**Restore the Factory Defaults of AIM 128**

### Enable/Disable AIM 128



@AIMENA1

**\*\* Enable AIM 128**



@AIMENA0

**Disable AIM 128**



If the scanner fails to identify AIM 128 barcodes, you may first try this solution by scanning the **Enter Setup** barcode and then **Enable AIM 128** barcode.



@SETUPE0

**\*\* Exit Setup**



@SETUPE1  
**Enter Setup**

## Set Length Range for AIM 128

The scanner can be configured to only decode AIM 128 barcodes with lengths that fall between (inclusive) the minimum and maximum lengths. To accomplish it, you need to set the minimum and maximum lengths.



**Set the Minimum Length (Default: 1)**



**Set the Maximum Length (Default: 48)**



If minimum length is set to be greater than maximum length, the scanner only decodes AIM 128 barcodes with either the minimum or maximum length. If minimum length is same as maximum length, only AIM 128 barcodes with that length are to be decoded.



**Set the scanner to decode AIM 128 barcodes containing between 8 and 12 characters:**

1. Scan the **Enter Setup** barcode.
2. Scan the **Set the Minimum Length** barcode.
3. Scan the numeric barcode “8” from the “Digit Barcodes” section in Appendix.
4. Scan the **Save** barcode from the “Save/Cancel Barcodes” section in Appendix.
5. Scan the **Set the Maximum Length** barcode.
6. Scan the numeric barcodes “1” and “2” from the “Digit Barcodes” section in Appendix.
7. Scan the **Save** barcode from the “Save/Cancel Barcodes” section in Appendix.
8. Scan the **Exit Setup** barcode.



@SETUPE0  
**\*\* Exit Setup**



@SETUPE1

**Enter Setup**

---

## ISBT 128

### Restore Factory Defaults



@IBTDEF

**Restore the Factory Defaults of ISBT 128**

### Enable/Disable ISBT 128



@IBTENA1

**Enable ISBT 128**



@IBTENA0

**\*\* Disable ISBT 128**



If the scanner fails to identify ISBT 128 barcodes, you may first try this solution by scanning the **Enter Setup** barcode and then **Enable ISBT 128** barcode.



@SETUPE0

**\*\* Exit Setup**



@SETUPE1

**Enter Setup**

---

## Code 49

### Restore Factory Defaults



@C49DEF

**Restore the Factory Defaults of Code 49**

### Enable/Disable Code 49



@C49ENA1

**Enable Code 49**



@C49ENA0

**\*\* Disable Code 49**



If the scanner fails to identify Code 49 barcodes, you may first try this solution by scanning the **Enter Setup** barcode and then **Enable Code 49** barcode.



@SETUPE0

**\*\* Exit Setup**



@SETUPE1

Enter Setup

## Set Length Range for Code 49

The scanner can be configured to only decode Code 49 barcodes with lengths that fall between (inclusive) the minimum and maximum lengths. To accomplish it, you need to set the minimum and maximum lengths.



@C49MIN

Set the Minimum Length (Default: 1)



@C49MAX

Set the Maximum Length (Default: 80)



If minimum length is set to be greater than maximum length, the scanner only decodes Code 49 barcodes with either the minimum or maximum length. If minimum length is same as maximum length, only Code 49 barcodes with that length are to be decoded.

## Example

Set the scanner to decode Code 49 barcodes containing between 8 and 12 characters:

1. Scan the **Enter Setup** barcode.
2. Scan the **Set the Minimum Length** barcode.
3. Scan the numeric barcode “8” from the “Digit Barcodes” section in Appendix.
4. Scan the **Save** barcode from the “Save/Cancel Barcodes” section in Appendix.
5. Scan the **Set the Maximum Length** barcode.
6. Scan the numeric barcodes “1” and “2” from the “Digit Barcodes” section in Appendix.
7. Scan the **Save** barcode from the “Save/Cancel Barcodes” section in Appendix.
8. Scan the **Exit Setup** barcode.



@SETUPE0

\*\* Exit Setup



@SETUPE1

**Enter Setup**

---

## Code 16K

### Restore Factory Defaults



@16KDEF

**Restore the Factory Defaults of Code 16K**

### Enable/Disable Code 16K



@16KENA1

**Enable Code 16K**



@16KENA0

**\*\* Disable Code 16K**



If the scanner fails to identify Code 16K barcodes, you may first try this solution by scanning the **Enter Setup** barcode and then **Enable Code 16K** barcode.



@SETUPE0

**\*\* Exit Setup**



@SETUPE1

Enter Setup

## Set Length Range for Code 16K

The scanner can be configured to only decode Code 16K barcodes with lengths that fall between (inclusive) the minimum and maximum lengths. To accomplish it, you need to set the minimum and maximum lengths.



@16KMIN

Set the Minimum Length (Default: 1)



@16KMAX

Set the Maximum Length (Default: 80)



If minimum length is set to be greater than maximum length, the scanner only decodes Code 16K barcodes with either the minimum or maximum length. If minimum length is same as maximum length, only Code 16K barcodes with that length are to be decoded.



**Set the scanner to decode Code 16K barcodes containing between 8 and 12 characters:**

1. Scan the **Enter Setup** barcode.
2. Scan the **Set the Minimum Length** barcode.
3. Scan the numeric barcode “8” from the “Digit Barcodes” section in Appendix.
4. Scan the **Save** barcode from the “Save/Cancel Barcodes” section in Appendix.
5. Scan the **Set the Maximum Length** barcode.
6. Scan the numeric barcodes “1” and “2” from the “Digit Barcodes” section in Appendix.
7. Scan the **Save** barcode from the “Save/Cancel Barcodes” section in Appendix.
8. Scan the **Exit Setup** barcode.



@SETUPE0

\*\* Exit Setup



@SETUPE1

**Enter Setup**

---

## PDF417

### Restore Factory Defaults



@PDFDEF

**Restore the Factory Defaults of PDF417**

### Enable/Disable PDF417



@PDFENA1

**\*\* Enable PDF417**



@PDFENA0

**Disable PDF417**



If the scanner fails to identify PDF417 barcodes, you may first try this solution by scanning the **Enter Setup** barcode and then **Enable PDF417** barcode.



@SETUPE0

**\*\* Exit Setup**





@SETUPE1

**Enter Setup**

---

## Set Length Range for PDF417

The scanner can be configured to only decode PDF417 barcodes with lengths that fall between (inclusive) the minimum and maximum lengths. To accomplish it, you need to set the minimum and maximum lengths.



@PDFMIN

**Set the Minimum Length (Default: 1)**



@PDFMAX

**Set the Maximum Length (Default: 2710)**



Minimum length is not allowed to be greater than maximum length. If you only want to read PDF417 barcodes with a specific length, set both minimum and maximum lengths to be that desired length.

**Set the scanner to decode PDF417 barcodes containing between 8 and 12 characters:**

**E**  
*xample*

1. Scan the **Enter Setup** barcode.
2. Scan the **Set the Minimum Length** barcode.
3. Scan the numeric barcode “8” from the “Digit Barcodes” section in Appendix.
4. Scan the **Save** barcode from the “Save/Cancel Barcodes” section in Appendix.
5. Scan the **Set the Maximum Length** barcode.
6. Scan the numeric barcodes “1” and “2” from the “Digit Barcodes” section in Appendix.
7. Scan the **Save** barcode from the “Save/Cancel Barcodes” section in Appendix.
8. Scan the **Exit Setup** barcode.



@SETUPE0

**\*\* Exit Setup**



@SETUPE1

**Enter Setup**

---

## PDF417 Twin Code

PDF417 twin code is 2 PDF417 barcodes paralleled vertically or horizontally. They must both be either regular or inverse barcodes. They must have similar specifications and be placed closely together.

There are 3 options for reading PDF417 twin codes:

- ◇ **Single PDF417 Only:** Read either PDF417 code.
- ◇ **Twin PDF417 Only:** Read both PDF417 codes.
- ◇ **Both Single & Twin:** Read both PDF417 codes. If successful, transmit as twin PDF417 only. Otherwise, try single PDF417 only.



@PDFDOU0

**\*\* Single PDF417 Only**



@PDFDOU1

**Twin PDF417 Only**



@PDFDOU2

**Both Single & Twin**



@SETUPE0

**\*\* Exit Setup**



@SETUPE1

Enter Setup

---

## PDF417 Inverse

Regular barcode: Dark bars on a bright background.

Inverse barcode: Bright bars on a dark background.



@PDFINV0

**\*\* Decode Regular PDF417 Barcodes Only**



@PDFINV1

**Decode Inverse PDF417 Barcodes Only**



@PDFINV2

**Decode Both**

## Character Encoding



@PDFENC0

**\*\* Default Character Encoding**



@PDFENC1

**UTF-8**



@PDFENC2

**Automatically select UTF-8 or Code Page**



@SETUPE0

**\*\* Exit Setup**



@SETUPE1

**Enter Setup**

---

## PDF417 ECI Output



@PDFECI0

**Disable PDF417 ECI Output**



@PDFECI1

**\*\* Enable PDF417 ECI Output**



@SETUPE0

**\*\* Exit Setup**



@SETUPE1

**Enter Setup**

---

## Micro PDF417

### Restore Factory Defaults



@MPDDEF

**Restore the Factory Defaults of Micro PDF417**

### Enable/Disable Micro PDF417



@MPDENA1

**Enable Micro PDF417**



@MPDENA0

**\*\* Disable Micro PDF417**



If the scanner fails to identify Micro PDF417 barcodes, you may first try this solution by scanning the **Enter Setup** barcode and then **Enable Micro PDF417** barcode.



@SETUPE0

**\*\* Exit Setup**



@SETUPE1  
**Enter Setup**

## Set Length Range for Micro PDF417

The scanner can be configured to only decode Micro PDF417 barcodes with lengths that fall between (inclusive) the minimum and maximum lengths. To accomplish it, you need to set the minimum and maximum lengths.



@MPDMIN  
**Set the Minimum Length (Default: 1)**



@MPDMAX  
**Set the Maximum Length (Default: 366)**



Minimum length is not allowed to be greater than maximum length. If you only want to read Micro PDF417 barcodes with a specific length, set both minimum and maximum lengths to be that desired length.



**Set the scanner to decode Micro PDF417 barcodes containing between 8 and 12 characters:**

1. Scan the **Enter Setup** barcode.
2. Scan the **Set the Minimum Length** barcode.
3. Scan the numeric barcode “8” from the “Digit Barcodes” section in Appendix.
4. Scan the **Save** barcode from the “Save/Cancel Barcodes” section in Appendix.
5. Scan the **Set the Maximum Length** barcode.
6. Scan the numeric barcodes “1” and “2” from the “Digit Barcodes” section in Appendix.
7. Scan the **Save** barcode from the “Save/Cancel Barcodes” section in Appendix.
8. Scan the **Exit Setup** barcode.



@SETUPE0  
**\*\* Exit Setup**



@SETUPE1

**Enter Setup**

---

## QR Code

### Restore Factory Defaults



@QRCDEF

**Restore the Factory Defaults of QR Code**

### Enable/Disable QR Code



@QRCENA1

**\*\* Enable QR Code**



@QRCENA0

**Disable QR Code**



If the scanner fails to identify QR Code barcodes, you may first try this solution by scanning the **Enter Setup** barcode and then **Enable QR Code** barcode.



@SETUPE0

**\*\* Exit Setup**



@SETUPE1  
Enter Setup

## Set Length Range for QR Code

The scanner can be configured to only decode QR Code barcodes with lengths that fall between (inclusive) the minimum and maximum lengths. To accomplish it, you need to set the minimum and maximum lengths.



@QRCPMIN  
Set the Minimum Length (Default: 1)



@QRCPMAX  
Set the Maximum Length (Default: 7089)



Minimum length is not allowed to be greater than maximum length. If you only want to read QR Code barcodes with a specific length, set both minimum and maximum lengths to be that desired length.

## Example

**Set the scanner to decode QR Code barcodes containing between 8 and 12 characters:**

1. Scan the **Enter Setup** barcode.
2. Scan the **Set the Minimum Length** barcode.
3. Scan the numeric barcode “8” from the “Digit Barcodes” section in Appendix.
4. Scan the **Save** barcode from the “Save/Cancel Barcodes” section in Appendix.
5. Scan the **Set the Maximum Length** barcode.
6. Scan the numeric barcodes “1” and “2” from the “Digit Barcodes” section in Appendix.
7. Scan the **Save** barcode from the “Save/Cancel Barcodes” section in Appendix.
8. Scan the **Exit Setup** barcode.



@SETUPE0  
\*\* Exit Setup





@SETUPE1

**Enter Setup**

---

## QR Twin Code

QR twin code is 2 QR barcodes paralleled vertically or horizontally. They must both be either regular or inverse barcodes. They must have similar specifications and be placed closely together.

There are 3 options for reading QR twin codes:

- ◇ **Single QR Only:** Read either QR code.
- ◇ **Twin QR Only:** Read both QR codes. Transmission sequence: left (upper) QR code followed by right (lower) QR code.
- ◇ **Both Single & Twin:** Read both QR codes. If successful, transmit as twin QR only. Otherwise, try single QR only.



@QRCDU0

**\*\* Single QR Only**



@QRCDU1

**Twin QR Only**



@QRCDU2

**Both Single & Twin**



@SETUPE0

**\*\* Exit Setup**



@SETUPE1

**Enter Setup**

---

### QR Inverse

Regular barcode: Dark bars on a bright background.

Inverse barcode: Bright bars on a dark background.



@QRCINV0

**\*\* Decode Regular QR Barcodes Only**



@QRCINV1

**Decode Inverse QR Barcodes Only**



@QRCINV2

**Decode Both**

### Character Encoding



@QRCENC0

**\*\* Default Character Encoding**



@QRCENC1

**UTF-8**



@QRCENC3

**Automatically select UTF-8 or Code Page**



@SETUPE0

**\*\* Exit Setup**



@SETUPE1

**Enter Setup**

---

## QR ECI Output



@QRCEC10

**Disable QR ECI Output**



@QRCEC1

**\*\* Enable QR ECI Output**



@SETUPE0

**\*\* Exit Setup**



@SETUPE1

**Enter Setup**

---

## Micro QR Code

### Restore Factory Defaults



@MQRDEF

**Restore the Factory Defaults of Micro QR**

### Enable/Disable Micro QR



@MQRENA1

**\*\* Enable Micro QR**



@MQRENA0

**Disable Micro QR**



If the scanner fails to identify Micro QR barcodes, you may first try this solution by scanning the **Enter Setup** barcode and then **Enable Micro QR** barcode.



@SETUPE0

**\*\* Exit Setup**



@SETUPE1

**Enter Setup**

---

## Set Length Range for Micro QR

The scanner can be configured to only decode Micro QR barcodes with lengths that fall between (inclusive) the minimum and maximum lengths. To accomplish it, you need to set the minimum and maximum lengths.



@MQRMIN

**Set the Minimum Length (Default: 1)**



@MQRMAX

**Set the Maximum Length (Default: 35)**



Minimum length is not allowed to be greater than maximum length. If you only want to read Micro QR barcodes with a specific length, set both minimum and maximum lengths to be that desired length.

**E**  
*sample*

**Set the scanner to decode Micro QR Code barcodes containing between 8 and 12 characters:**

1. Scan the **Enter Setup** barcode.
2. Scan the **Set the Minimum Length** barcode.
3. Scan the numeric barcode “8” from the “Digit Barcodes” section in Appendix.
4. Scan the **Save** barcode from the “Save/Cancel Barcodes” section in Appendix.
5. Scan the **Set the Maximum Length** barcode.
6. Scan the numeric barcodes “1” and “2” from the “Digit Barcodes” section in Appendix.
7. Scan the **Save** barcode from the “Save/Cancel Barcodes” section in Appendix.
8. Scan the **Exit Setup** barcode.



@SETUPE0

**\*\* Exit Setup**



@SETUPE1

**Enter Setup**

---

## Aztec

### Restore Factory Defaults



@AZTDEF

**Restore the Factory Defaults of Aztec Code**

### Enable/Disable Aztec Code



@AZTENA1

**Enable Aztec Code**



@AZTENA0

**\*\* Disable Aztec Code**



If the scanner fails to identify Aztec Code barcodes, you may first try this solution by scanning the **Enter Setup** barcode and then **Enable Aztec Code** barcode.



@SETUPE0

**\*\* Exit Setup**



@SETUPE1

**Enter Setup**

---

## Set Length Range for Aztec Code

The scanner can be configured to only decode Aztec barcodes with lengths that fall between (inclusive) the minimum and maximum lengths. To accomplish it, you need to set the minimum and maximum lengths.



@AZTMIN

**Set the Minimum Length (Default: 1)**



@AZTMAX

**Set the Maximum Length (Default: 3832)**



Minimum length is not allowed to be greater than maximum length. If you only want to read Aztec barcodes with a specific length, set both minimum and maximum lengths to be that desired length.

**E**  
*xample*

**Set the scanner to decode Aztec barcodes containing between 8 and 12 characters:**

1. Scan the **Enter Setup** barcode.
2. Scan the **Set the Minimum Length** barcode.
3. Scan the numeric barcode “8” from the “Digit Barcodes” section in Appendix.
4. Scan the **Save** barcode from the “Save/Cancel Barcodes” section in Appendix.
5. Scan the **Set the Maximum Length** barcode.
6. Scan the numeric barcodes “1” and “2” from the “Digit Barcodes” section in Appendix.
7. Scan the **Save** barcode from the “Save/Cancel Barcodes” section in Appendix.
8. Scan the **Exit Setup** barcode.



@SETUPE0

**\*\* Exit Setup**



@SETUPE1

Enter Setup

---

## Read Multi-barcodes on an Image

There are three options:

- ◇ **Mode 1:** Read one barcode only.
- ◇ **Mode 2:** Read fixed number of barcodes only.
- ◇ **Mode 3:** Composite Reading. Read fixed number of barcodes first. If unsuccessful, read one barcode only.



@AZTMOD1

\*\* Mode 1



@AZTMOD2

Mode 2



@AZTMOD3

Mode 3



@SETUPE0

\*\* Exit Setup





@SETUPE1

Enter Setup

---

## Set the Number of Barcodes



@AZTMUL1

\*\* 1



@AZTMUL2

2



@AZTMUL3

3



@AZTMUL4

4



@AZTMUL5

5



@AZTMUL6

6



@AZTMUL7

7



@AZTMUL8

8



@SETUPE0

\*\* Exit Setup



@SETUPE1

Enter Setup

---

## Character Encoding



@AZTENC0

\*\* Default Character Encoding



@AZTENC1

UTF-8

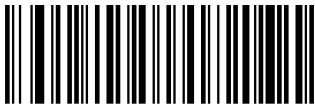

@AZTENC2

Automatically select UTF-8 or Code Page

## Aztec ECI Output



@AZTECI0

Disable Aztec ECI Output



@AZTECI1

\*\* Enable Aztec ECI Output



@SETUPE0

\*\* Exit Setup



@SETUPE1

**Enter Setup**

---

## Data Matrix

### Restore Factory Defaults



@DMCDEF

**Restore the Factory Defaults of Data Matrix**

### Enable/Disable Data Matrix



@DMCENA1

**\*\* Enable Data Matrix**



@DMCENA0

**Disable Data Matrix**



If the scanner fails to identify Data Matrix barcodes, you may first try this solution by scanning the **Enter Setup** barcode and then **Enable Data Matrix** barcode.



@SETUPE0

**\*\* Exit Setup**



@SETUPE1  
**Enter Setup**

---

## Set Length Range for Data Matrix

The scanner can be configured to only decode Data Matrix barcodes with lengths that fall between (inclusive) the minimum and maximum lengths. To accomplish it, you need to set the minimum and maximum lengths.



**Set the Minimum Length (Default: 1)**



**Set the Maximum Length (Default: 3116)**



Minimum length is not allowed to be greater than maximum length. If you only want to read Data Matrix barcodes with a specific length, set both minimum and maximum lengths to be that desired length.

## **E** *sample*

**Set the scanner to decode Data Matrix barcodes containing between 8 and 12 characters:**

1. Scan the **Enter Setup** barcode.
2. Scan the **Set the Minimum Length** barcode.
3. Scan the numeric barcode “8” from the “Digit Barcodes” section in Appendix.
4. Scan the **Save** barcode from the “Save/Cancel Barcodes” section in Appendix.
5. Scan the **Set the Maximum Length** barcode.
6. Scan the numeric barcodes “1” and “2” from the “Digit Barcodes” section in Appendix.
7. Scan the **Save** barcode from the “Save/Cancel Barcodes” section in Appendix.
8. Scan the **Exit Setup** barcode.



@SETUPE0  
**\*\* Exit Setup**



@SETUPE1

Enter Setup

---

## Data Matrix Twin Code

Data Matrix twin code is 2 Data Matrix barcodes paralleled vertically or horizontally. They must both be either regular or inverse barcodes. They must have similar specifications and be placed closely together.

There are 3 options for reading Data Matrix twin codes:

- ◇ **Single Data Matrix Only:** Read either Data Matrix code.
- ◇ **Twin Data Matrix Only:** Read both Data Matrix codes. Transmission sequence: left (upper) Data Matrix code followed by right (lower) Data Matrix code.
- ◇ **Both Single & Twin:** Read both Data Matrix codes. If successful, transmit as twin Data Matrix only. Otherwise, try single Data Matrix only.



@DMCDOU0

**\*\* Single Data Matrix Only**



@DMCDOU1

**Twin Data Matrix Only**



@DMCDOU2

**Both Single & Twin**



@SETUPE0

**\*\* Exit Setup**



@SETUPE1

**Enter Setup**

---

## Rectangular Barcode

Data Matrix has two formats:

Square barcodes having the same amount of modules in length and width: 10\*10, 12\*12.... 144\*144.

Rectangular barcodes having different amounts of models in length and width: 6\*16, 6\*14...14\*22.



@DMCREC1

**\*\* Enable Rectangular Barcode**



@DMCREC0

**Disable Rectangular Barcode**

## Data Matrix Inverse

Regular barcode: Dark bars on a bright background.

Inverse barcode: Bright bars on a dark background.



@DMCINV0

**\*\* Decode Regular Data Matrix Barcodes Only**



@DMCINV1

**Decode Inverse Data Matrix Barcodes Only**



@DMCINV2

**Decode Both**



@SETUPE0

**\*\* Exit Setup**



@SETUPE1

Enter Setup

---

## Character Encoding



@DMCENC0

\*\* Default Character Encoding

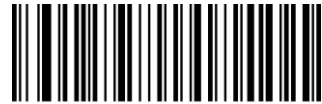

@DMCENC1

UTF-8

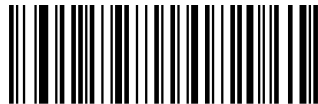

@DMCENC2

Automatically select UTF-8 or Code Page

## Data Matrix ECI Output



@DMCEC10

Disable Data Matrix ECI Output



@DMCEC11

\*\* Enable Data Matrix ECI Output



@SETUPE0

\*\* Exit Setup



@SETUPE1

**Enter Setup**

---

## Maxicode

### Restore Factory Defaults



@MXCDEF

**Restore the Factory Defaults of Maxicode**

### Enable/Disable Maxicode



@MXCENA1

**Enable Maxicode**



@MXCENA0

**\*\* Disable Maxicode**



If the scanner fails to identify Maxicode barcodes, you may first try this solution by scanning the **Enter Setup** barcode and then **Enable Maxicode** barcode.



@SETUPE0

**\*\* Exit Setup**





@SETUPE1

**Enter Setup**

---

## Set Length Range for Maxicode

The scanner can be configured to only decode Maxicode barcodes with lengths that fall between (inclusive) the minimum and maximum lengths. To accomplish it, you need to set the minimum and maximum lengths.



@MXCMIN

**Set the Minimum Length (Default: 1)**



@MXCMAX

**Set the Maximum Length (Default:150)**



Minimum length is not allowed to be greater than maximum length. If you only want to read Maxicode barcodes with a specific length, set both minimum and maximum lengths to be that desired length.



**Set the scanner to decode Maxicode barcodes containing between 8 and 12 characters:**

1. Scan the **Enter Setup** barcode.
2. Scan the **Set the Minimum Length** barcode.
3. Scan the numeric barcode “8” from the “Digit Barcodes” section in Appendix.
4. Scan the **Save** barcode from the “Save/Cancel Barcodes” section in Appendix.
5. Scan the **Set the Maximum Length** barcode.
6. Scan the numeric barcodes “1” and “2” from the “Digit Barcodes” section in Appendix.
7. Scan the **Save** barcode from the “Save/Cancel Barcodes” section in Appendix.
8. Scan the **Exit Setup** barcode.



@SETUPE0

**\*\* Exit Setup**



@SETUPE1

**Enter Setup**

---

## Chinese Sensible Code

**Restore Factory Defaults**



@CSCDEF

**Restore the Factory Defaults of Chinese Sensible Code**

**Enable/Disable Chinese Sensible Code**



@CSCENA1

**Enable Chinese Sensible Code**



@CSCENA0

**\*\* Disable Chinese Sensible Code**



If the scanner fails to identify Chinese Sensible Code barcodes, you may first try this solution by scanning the **Enter Setup** barcode and then **Enable Chinese Sensible Code** barcode.



@SETUPE0

**\*\* Exit Setup**



@SETUPE1

Enter Setup

## Set Length Range for Chinese Sensible Code

The scanner can be configured to only decode Chinese Sensible Code barcodes with lengths that fall between (inclusive) the minimum and maximum lengths. To accomplish it, you need to set the minimum and maximum lengths.



@CSCMIN

Set the Minimum Length (Default: 1)



@CSCMAX

Set the Maximum Length (Default: 7827)



Minimum length is not allowed to be greater than maximum length. If you only want to read Chinese Sensible Code barcodes with a specific length, set both minimum and maximum lengths to be that desired length.

## Example

Set the scanner to decode Chinese Sensible Code barcodes containing between 8 and 12 characters:

1. Scan the **Enter Setup** barcode.
2. Scan the **Set the Minimum Length** barcode.
3. Scan the numeric barcode “8” from the “Digit Barcodes” section in Appendix.
4. Scan the **Save** barcode from the “Save/Cancel Barcodes” section in Appendix.
5. Scan the **Set the Maximum Length** barcode.
6. Scan the numeric barcodes “1” and “2” from the “Digit Barcodes” section in Appendix.
7. Scan the **Save** barcode from the “Save/Cancel Barcodes” section in Appendix.
8. Scan the **Exit Setup** barcode.



@SETUPE0

\*\* Exit Setup



@SETUPE1

**Enter Setup**

---

### Chinese Sensible Twin Code

Chinese Sensible twin code is 2 Chinese Sensible barcodes paralleled vertically or horizontally. They must both be either regular or inverse barcodes. They must have similar specifications and be placed closely together.

There are 3 options for reading Chinese Sensible twin codes:

- ◇ **Single Chinese Sensible Code Only:** Read either Chinese Sensible code.
- ◇ **Twin Chinese Sensible Code Only:** Read both Chinese Sensible codes. Transmission sequence: left (upper) Chinese Sensible code followed by right (lower) Chinese Sensible code.
- ◇ **Both Single & Twin:** Read both Chinese Sensible codes. If successful, transmit as twin Chinese Sensible Code only. Otherwise, try single Chinese Sensible Code only.



@CSCDOU0

**\*\* Single Chinese Sensible Code Only**



@CSCDOU1

**Twin Chinese Sensible Code Only**



@CSCDOU2

**Both Single & Twin**



@SETUPE0

**\*\* Exit Setup**



@SETUPE1

**Enter Setup**

---

### Chinese Sensible Code Inverse

Regular barcode: Dark bars on a bright background.

Inverse barcode: Bright bars on a dark background.



@CSCINV0

**\*\* Decode Regular Chinese Sensible Barcodes Only**



@CSCINV1

**Decode Inverse Chinese Sensible Barcodes Only**



@CSCINV2

**Decode Both**



@SETUPE0

**\*\* Exit Setup**



@SETUPE1

**Enter Setup**

---

## GM Code

### Restore Factory Defaults



@GMCDEF

**Restore the Factory Defaults of GM**

### Enable/Disable GM



@GMCENA1

**Enable GM**



@GMCENA0

**\*\* Disable GM**



If the scanner fails to identify GM barcodes, you may first try this solution by scanning the **Enter Setup** barcode and then **Enable GM** barcode.



@SETUPE0

**\*\* Exit Setup**



@SETUPE1

**Enter Setup**

---

## Set Length Range for GM

The scanner can be configured to only decode GM barcodes with lengths that fall between (inclusive) the minimum and maximum lengths. To accomplish it, you need to set the minimum and maximum lengths.



@GMCMIN

**Set the Minimum Length (Default: 1)**



@GMCMAX

**Set the Maximum Length (Default: 2751)**



Minimum length is not allowed to be greater than maximum length. If you only want to read GM barcodes with a specific length, set both minimum and maximum lengths to be that desired length.



**Set the scanner to decode GM barcodes containing between 8 and 12 characters:**

1. Scan the **Enter Setup** barcode.
2. Scan the **Set the Minimum Length** barcode.
3. Scan the numeric barcode “8” from the “Digit Barcodes” section in Appendix.
4. Scan the **Save** barcode from the “Save/Cancel Barcodes” section in Appendix.
5. Scan the **Set the Maximum Length** barcode.
6. Scan the numeric barcodes “1” and “2” from the “Digit Barcodes” section in Appendix.
7. Scan the **Save** barcode from the “Save/Cancel Barcodes” section in Appendix.
8. Scan the **Exit Setup** barcode.



@SETUPE0

**\*\* Exit Setup**



@SETUPE1

**Enter Setup**

---

## Code One

### Restore Factory Defaults



@ONEDEF

**Restore the Factory Defaults of Code One**

### Enable/Disable Code One



@ONEENA1

**Enable Code One**



@ONEENA0

**\*\* Disable Code One**



If the scanner fails to identify Code One barcodes, you may first try this solution by scanning the **Enter Setup** barcode and then **Enable Code One** barcode.



@SETUPE0

**\*\* Exit Setup**





@SETUPE1

**Enter Setup**

---

## Set Length Range for Code One

The scanner can be configured to only decode Code One barcodes with lengths that fall between (inclusive) the minimum and maximum lengths. To accomplish it, you need to set the minimum and maximum lengths.



@ONEMIN

**Set the Minimum Length (Default: 1)**



@ONEMAX

**Set the Maximum Length (Default: 3550)**



Minimum length is not allowed to be greater than maximum length. If you only want to read Code One barcodes with a specific length, set both minimum and maximum lengths to be that desired length.

## **E** *sample*

**Set the scanner to decode Code One barcodes containing between 8 and 12 characters:**

1. Scan the **Enter Setup** barcode.
2. Scan the **Set the Minimum Length** barcode.
3. Scan the numeric barcode “8” from the “Digit Barcodes” section in Appendix.
4. Scan the **Save** barcode from the “Save/Cancel Barcodes” section in Appendix.
5. Scan the **Set the Maximum Length** barcode.
6. Scan the numeric barcodes “1” and “2” from the “Digit Barcodes” section in Appendix.
7. Scan the **Save** barcode from the “Save/Cancel Barcodes” section in Appendix.
8. Scan the **Exit Setup** barcode.



@SETUPE0

**\*\* Exit Setup**



@SETUPE1  
Enter Setup

## USPS Postnet

### Restore Factory Defaults



@PNTDEF  
Restore the Factory Defaults of USPS Postnet

### Enable/Disable USPS Postnet



@PNTENA1  
Enable USPS Postnet



@PNTENA0  
**\*\* Disable USPS Postnet**



If the scanner fails to identify USPS Postnet barcodes, you may first try this solution by scanning the **Enter Setup** barcode and then **Enable USPS Postnet** barcode.

### Transmit Check Character



@PNTCHK1  
Do Not Transmit USPS Postnet Check Character



@PNTCHK2  
**\*\* Transmit USPS Postnet Check Character**



@SETUPE0  
**\*\* Exit Setup**



@SETUPE1

**Enter Setup**

---

## USPS Intelligent Mail

### Restore Factory Defaults



@ILGDEF

**Restore the Factory Defaults of USPS Intelligent Mail**

### Enable/Disable USPS Intelligent Mail



@ILGENA1

**Enable USPS Intelligent Mail**



@ILGENA0

**\*\* Disable USPS Intelligent Mail**



If the scanner fails to identify USPS Intelligent Mail barcodes, you may first try this solution by scanning the **Enter Setup** barcode and then **Enable USPS Intelligent Mail** barcode.



@SETUPE0

**\*\* Exit Setup**



@SETUPE1

**Enter Setup**

---

## Royal Mail

### Restore Factory Defaults



@ROYDEF

**Restore the Factory Defaults of Royal Mail**

### Enable/Disable Royal Mail



@ROYENA1

**Enable Royal Mail**



@ROYENA0

**\*\* Disable Royal Mail**



If the scanner fails to identify Royal Mail barcodes, you may first try this solution by scanning the **Enter Setup** barcode and then **Enable Royal Mail** barcode.



@SETUPE0

**\*\* Exit Setup**



@SETUPE1

Enter Setup

## USPS Planet

### Restore Factory Defaults



@PLADEF

Restore the Factory Defaults of USPS Planet

### Enable/Disable USPS Planet



@PLAENA1

Enable USPS Planet



@PLAENA0

\*\* Disable USPS Planet



If the scanner fails to identify USPS Planet barcodes, you may first try this solution by scanning the **Enter Setup** barcode and then **Enable USPS Planet** barcode.

### Transmit Check Character



@PLACHK1

Do Not Transmit USPS Planet Check Character



@PLACHK2

\*\* Transmit USPS Planet Check Character



@SETUPE0

\*\* Exit Setup



@SETUPE1

**Enter Setup**

---

## KIX Post

### Restore Factory Defaults



@KIXDEF

**Restore the Factory Defaults of KIX Post**

### Enable/Disable KIX Post



@KIXENA1

**Enable KIX Post**



@KIXENA0

**\*\* Disable KIX Post**



If the scanner fails to identify KIX Post barcodes, you may first try this solution by scanning the **Enter Setup** barcode and then **Enable KIX Post** barcode.



@SETUPE0

**\*\* Exit Setup**



@SETUPE1

**Enter Setup**

---

## Australian Postal

### Restore Factory Defaults



@APLDEF

**Restore the Factory Defaults of Australian Postal**

### Enable/Disable Australian Postal



@APLENA1

**Enable Australian Postal**



@APLENA0

**\*\* Disable Australian Postal**



If the scanner fails to identify Australian Postal barcodes, you may first try this solution by scanning the **Enter Setup** barcode and then **Enable Australian Postal** barcode.



@SETUPE0

**\*\* Exit Setup**



@SETUPE1

**Enter Setup**

---

## Passport OCR

### Restore Factory Defaults



@PASDEF

**Restore the Factory Defaults of Passport OCR**

### Enable/Disable Passport OCR



@PASENA1

**Enable Passport OCR**



@PASENA0

**\*\* Disable Passport OCR**



If the scanner fails to identify Passport OCR barcodes, you may first try this solution by scanning the **Enter Setup** barcode and then **Enable Passport OCR** barcode.



@SETUPE0

**\*\* Exit Setup**





## Chapter 8 Data Formatter

### Introduction

You may use the Data Formatter to modify the scanner's output. For example, you can use the Data Formatter to insert characters at certain points in barcode data or to suppress/ replace/ send certain characters in barcode data as it is scanned.

Normally, when you scan a barcode, it gets outputted automatically; however, when you create a format, you must use a "send" command (see the "Send Commands" section in this chapter) within the format programming to output data. Multiple data formats can be programmed into the scanner. The maximum size of all data formats created is 2048 characters. By default, the data formatter is disabled. Enable it when required. If you have changed data format settings, and wish to clear all formats and return to the factory defaults, scan the **Default Data Format** barcode below.



### Add a Data Format

Data format is used to edit barcode data. When you create a data format, you must select one of the four labels (Format\_0, Format\_1, Format\_2 and Format\_3) for your data format, specify the application scope of data format (such as barcode type and data length) and include formatter commands. Multiple data formats may be created using the same label. When scanned data does not match your data format requirements, you will hear the non-match error beep (if the non-match error beep is ON).

There are two methods to program a data format: Programming with barcodes and programming with serial commands.

### Programming with Barcodes

The following explains how to program a data format by scanning the specific barcodes. Scanning any irrelevant barcode or failing to follow the setting procedure will result in programming failure. To find the alphanumeric barcodes needed to create a data format, see the "Digit Barcodes" section in Appendix.

**Step 1:** Scan the **Enter Setup** barcode.





**@SETUPE1**  
**Enter Setup**

**Step 2:** Scan the **Add Data Format** barcode.



**@DFMADD**  
**Add Data Format**

**Step 3:** Select a label (Format\_0 or Format\_1 or Format\_2 or Format\_3).

Scan a numeric barcode **0** or **1** or **2** or **3** to label this data format Format\_0 or Format\_1 or Format\_2 or Format\_3.

**Step 4:** Select formatter command type.

Specify what type of formatter commands will be used. Scan a numeric barcode “6” to select formatter command type 6. (See the “Formatter Command Type 6” section in this chapter for more information)

**Step 5:** Set interface type

Scan **999** for any interface type.

**Step 6:** Set Symbology ID Number

Refer to the “Symbology ID Number” section in Appendix and find the ID number of the symbology to which you want to apply the data format. Scan three numeric barcodes for the symbology ID number. If you wish to create a data format for all symbologies, scan **999**.

**Step 7:** Set barcode data length

Specify what length of data will be acceptable for this symbology. Scan the four numeric barcodes that represent the data length. 9999 is a universal number, indicating all lengths. For example, 32 characters should be entered as 0032.

**Step 8:** Enter formatter command

Refer to the “Formatter Command Type 6” section in this chapter. Scan the alphanumeric barcodes that represent the command you need to edit data. For example, when a command is F141, you should scan F141.

**Step 9:** Scan the **Save** barcode from the “Save/Cancel Barcodes” section in Appendix to save your data format.



**@SETUPE0**  
**\*\* Exit Setup**



@SETUPE1

**Enter Setup**

---

**Example:** Program a Format\_0 data format using formatter command type 6, Code 128 containing 10 characters applicable, send all characters followed by "A".

- |   |   |
|---|---|
| 1. Scan the <b>Enter Setup</b> barcode        | Enter the Setup mode                          |
| 2. Scan the <b>Add Data Format</b> barcode    | Add a data format                             |
| 3. Scan the <b>0</b> barcode                  | Select Format_0 as the label                  |
| 4. Scan the <b>6</b> barcode                  | Select formatter command type 6               |
| 5. Scan the <b>9</b> barcode three times      | All interface types applicable                |
| 6. Scan the barcodes <b>002</b>               | Only Code 128 applicable                      |
| 7. Scan the barcodes <b>0010</b>              | Only a length of 10 characters applicable     |
| 8. Scan the alphanumeric barcodes <b>F141</b> | Send all characters followed by "A" (HEX: 41) |
| 9. Scan the <b>Save</b> barcode               | Save the data format                          |

To streamline the programming process, you may as well generate a batch barcode by inputting the command (e.g. **@DFMADD069990020010F141;**) used to create a data format. See the "Use Batch Barcode" section in Chapter 10 to learn how to put a batch barcode into use.

When creating multiple data formats sharing a label, the formats are separated from each other by a vertical bar (|) in the batch command, e.g. **@DFMADD069990029999F141|069990039999F142|169990049999F143;**.



@SETUPE0

**\*\* Exit Setup**



@SETUPE1  
Enter Setup

---

## Programming with Serial Commands

A data format can also be created by serial commands (HEX) sent from the host device. **All commands must be entered in uppercase letters.**

The syntax consists of the following elements:

**Prefix:** "~<SOH>0000" (HEX: **7E 01 30 30 30 30**), 6 characters.

**Storage type:** "@" (HEX: **40**) or "#" (HEX: **23**), 1 character. "@" means permanent setting which will not be lost by removing power from the scanner or rebooting it; "#" means temporary setting which will be lost by removing power from the scanner or rebooting it.

**Add Data Format Command:** "DFMADD" (HEX: **44 46 4D 41 44 44**), 6 characters.

**Data format label:** "0" (HEX: **30**) or "1" (HEX: **31**) or "2" (HEX: **32**) or "3" (HEX: **33**), 1 character. "0", "1", "2" and "3" represent Format\_0, Format\_1, Format\_2 and Format\_3 respectively.

**Formatter command type:** "6" (HEX: **36**), 1 character.

**Interface type:** "999" (HEX: **39 39 39**), 3 characters.

**Symbology ID Number:** The ID number of the symbology to which you want to apply the data format, 3 characters. 999 indicates all symbologies.

**Data length:** The length of data that will be acceptable for this symbology, 4 characters. 9999 indicates all lengths. For example, 32 characters should be entered as 0032.

**Formatter commands:** The command string used to edit data. For more information, see the "Formatter Command Type 6" section in this chapter.

**Suffix:** ";<ETX>" (HEX: **3B 03**), 2 characters.

**Example:** Program a Format\_0 data format using formatter command type 6, Code 128 containing 10 characters applicable, send all characters followed by "A".

Enter: **7E 01 30 30 30 30 40 44 46 4D 41 44 44 30 36 39 39 39 30 30 33 39 39 39 39 46 31 34 31 3B 03**  
(~<SOH>0000@DFMADD069990020010F141;<ETX>)

Response: **02 01 30 30 30 30 40 44 46 4D 41 44 44 30 36 39 39 39 30 30 33 39 39 39 39 46 31 34 31 06 3B 03**  
(<STX><SOH>0000@DFMADD069990020010F141<ACK>;<ETX>)

When creating multiple data formats sharing a label, the formats are separated from each other by a vertical bar (|) in the serial command.

**Example:** ~<SOH>0000@DFMADD069990020010F141|069990039999F142|069990049999F143;<ETX>



@SETUPE0  
\*\* Exit Setup



@SETUPE1

Enter Setup

---

## Enable/Disable Data Formatter

When Data Formatter is disabled, the barcode data is outputted to the host as read, including prefixes and suffixes.



@DFMENA0

**\*\* Disable Data Formatter**

You may wish to require the data to conform to a data format you have created. The following settings can be applied to your data format:

**Enable Data Formatter, Required, Keep Prefix/Suffix:** Scanned data that meets your data format requirements is modified accordingly and gets outputted along with prefixes and suffixes (if prefix and suffix are enabled). Any data that does not match your data format requirements generates an error beep (if Non-Match Error Beep is turned ON) and the data in that barcode is not transmitted.

**Enable Data Formatter, Required, Drop Prefix/Suffix:** Scanned data that meets your data format requirements is modified accordingly and gets outputted without prefixes and suffixes (even if prefix and suffix are enabled). Any data that does not match your data format requirements generates an error beep (if Non-Match Error Beep is turned ON) and the data in that barcode is not transmitted.

**Enable Data Formatter, Not Required, Keep Prefix/Suffix:** Scanned data that meets your data format requirements is modified accordingly and gets outputted along with prefixes and suffixes (if prefix and suffix are enabled). Barcode data that does not match your data format requirements is transmitted as read along with prefixes and suffixes (if prefix and suffix are enabled).

**Enable Data Formatter, Not Required, Drop Prefix/Suffix:** Scanned data that meets your data format requirements is modified accordingly and gets outputted without prefixes and suffixes (even if prefix and suffix are enabled). Barcode data that does not match your data format requirements is transmitted as read along with prefixes and suffixes (if prefix and suffix are enabled).



@SETUPE0

**\*\* Exit Setup**



@SETUPE1

**Enter Setup**

---



@DFMENA1

**Enable Data Formatter, Required, Keep Prefix/Suffix**



@DFMENA2

**Enable Data Formatter, Required, Drop Prefix/Suffix**



@DFMENA3

**Enable Data Formatter, Not Required, Keep Prefix/Suffix**



@DFMENA4

**Enable Data Formatter, Not Required, Drop Prefix/Suffix**

## Non-Match Error Beep

If Non-Match Error Beep is turned ON, the scanner generates an error beep when a barcode is encountered that does not match your required data format.



@DFMTON0

**Non-Match Error Beep Off**



@DFMTON1

**\*\* Non-Match Error Beep On**



@SETUPE0

**\*\* Exit Setup**



@SETUPE1

**Enter Setup**

---

## Data Format Selection

After enabling the Data Formatter, you can select a data format you want to use by scanning the appropriate barcode below.



@DFMUSE0

**\*\* Format\_0**



@DFMUSE2

**Format\_2**



@DFMUSE1

**Format\_1**



@DFMUSE3

**Format\_3**



@SETUPE0

**\*\* Exit Setup**



@SETUPE1

**Enter Setup**

---

## Change Data Format for a Single Scan

You can switch between data formats for a single scan. The next barcode is scanned using the data format selected here, then reverts to the format you have selected above.

For example, you may have set your scanner to use the data format you saved as Format\_3. You can switch to Format\_1 for a single trigger pull by scanning the **Single Scan – Format\_1** barcode below. The next barcode that is scanned uses Format\_1, then reverts back to Format\_3.

Note: This setting will be lost by removing power from the scanner, or turning off/ rebooting the device.



@DFMSIN0

**Single Scan – Format\_0**



@DFMSIN2

**Single Scan – Format\_2**



@DFMSIN1

**Single Scan – Format\_1**



@DFMSIN3

**Single Scan – Format\_3**



@SETUPE0

**\*\* Exit Setup**





@SETUPE1

Enter Setup

---

## Clear Data Format

There are two methods to remove data format created from your scanner:

Delete one data format: Scan the **Clear One** barcode, a numeric barcode (0-3) and the **Save** barcode. For example, to delete Format\_2, you should scan the **Clear One** barcode, the **2** barcode and the **Save** barcode

Delete all data formats: Scan the **Clear All** barcode.



@DFMCAL

Clear All



@DFMCLR

Clear One

## Query Data Formats

You may scan the appropriate barcode below to get the information of data format(s) created by you or preset by manufacturer. For instance, if you have added Format\_0 as per the example in the “Add a Data Format” section in this chapter, scanning the **Query Current Data Formats** barcode, you will get the result: **Data Format0:069990020010F141;**



@DFMQCU

Query Current Data Formats



@DFMQFA

Query Preset Data Formats



@SETUPE0

\*\* Exit Setup



@SETUPE1  
Enter Setup

---

## Formatter Command Type 6

When working with the Data Formatter, a virtual cursor is moved along your input data string. The following commands are used to both move this cursor to different positions, and to select, replace, and insert data into the final output. For the hex value of ASCII characters involved in the commands, refer to the "ASCII Table" in Appendix.

### Send Commands

#### F1 Send all characters

Syntax=F1xx (xx: The insert character's hex value)

Include in the output message all of the characters from the input message, starting from current cursor position, followed by an insert character.

#### F2 Send a number of characters

Syntax=F2nxx (nn: The numeric value (00-99) for the number of characters; xx: The insert character's hex value)

Include in the output message a number of characters followed by an insert character. Start from the current cursor position and continue for "nn" characters or through the last character in the input message, followed by character "xx."

#### F2 Example: Send a number of characters



1234567890ABCDEFGHIJ

Send the first 10 characters from the barcode above, followed by a carriage return.

Command string: **F2100D**

F2 is the "Send a number of characters" command

10 is the number of characters to send

0D is the hex value for a CR

The data is output as: **1234567890**

**<CR>**



@SETUPE0  
**\*\* Exit Setup**



@SETUPE1

Enter Setup

---

### F3 Send all characters up to a particular character

Syntax=F3ssxx (ss: The particular character's hex value; xx: The insert character's hex value)

Include in the output message all characters from the input message, starting with the character at the current cursor position and continuing to, but not including, the particular character "ss," followed by character "xx." The cursor is moved forward to the "ss" character.

### F3 Example: Send all characters up to a particular character



1234567890ABCDEFGHIJ

Using the barcode above, send all characters up to but not including "D," followed by a carriage return.

Command string: **F3440D**

F3 is the "Send all characters up to a particular character" command

44 is the hex value for a "D"

0D is the hex value for a CR

The data is output as: **1234567890ABC**

**<CR>**



@SETUPE0

\*\* Exit Setup



@SETUPE1  
Enter Setup

---

### **B9 Send all characters up to a particular string**

Syntax=B9nnns...s (nnnn: The length of the particular string; s...s: The hex value of each character in the particular string)

Include in the output message all characters from the input message, starting with the character at the current cursor position and continuing to, but not including, the particular string "s...s." The cursor is moved forward to the beginning of the "s...s" string.

#### **B9 Example: Send all characters up to a particular string**



1234567890ABCDEFGHIJ

Using the barcode above, send all characters up to but not including "AB."

Command string: **B900024142**

B9 is the "Send all characters up to a particular string" command

0002 is the length of the particular string (2 characters)

41 is the hex value for a "A" (character in the string)

42 is the hex value for a "B" (character in the string)

The data is output as: **1234567890**

### **E9 Send all but the last characters**

Syntax=E9nn (nn: The numeric value (00-99) for the number of characters that will not be sent at the end of the message)

Include in the output message all but the last "nn" characters, starting from the current cursor position. The cursor is moved forward to one position past the last input message character included.

### **F4 Insert a character multiple times**

Syntax=F4xxnn (xx: The insert character's hex value; nn: The numeric value (00-99) for the number of times it should be sent)

Send "xx" character "nn" times in the output message, leaving the cursor in the current position.

---



@SETUPE0  
**\*\* Exit Setup**



@SETUPE1

Enter Setup

---

### E9 and F4 Example: Send all but the last characters, followed by 2 tabs



1234567890ABCDEFGHIJ

Send all characters except for the last 8 from the barcode above, followed by 2 tabs.

Command string: **E908F40902**

E9 is the “Send all but the last characters” command

08 is the number of characters at the end to ignore

F4 is the “Insert a character multiple times” command

09 is the hex value for a horizontal tab

02 is the number of time the tab character is sent

The data is output as: **1234567890AB<tab><tab>**

### B3 Insert symbology name

Insert the name of the barcode’s symbology in the output message, without moving the cursor.

### B4 Insert barcode length

Insert the barcode’s length in the output message, without moving the cursor. The length is expressed as a numeric string and does not include leading zeros.



@SETUPE0

\*\* Exit Setup



@SETUPE1  
Enter Setup

---

### B3 and B4 Example: Insert the symbology name and length



1234567890ABCDEFGHIJ

Send the symbology name and length before the barcode data from the barcode above. Break up these insertions with spaces. End with a carriage return.

Command string: **B3F42001B4F42001F10D**

B3 is the "Insert symbology name" command

F4 is the "Insert a character multiple times" command

20 is the hex value for a space

01 is the number of time the space character is sent

B4 is the "Insert barcode length" command

F4 is the "Insert a character multiple times" command

20 is the hex value for a space

01 is the number of time the space character is sent

F1 is the "Send all characters" command

0D is the hex value for a CR

The data is output as: **Code128 20 1234567890ABCDEFGHIJ**

**<CR>**

## Move Commands

### F5 Move the cursor forward a number of characters

Syntax=F5nn (nn: The numeric value (00-99) for the number of characters the cursor should be moved ahead)

Move the cursor ahead "nn" characters from current cursor position.



@SETUPE0  
**\*\* Exit Setup**



@SETUPE1

Enter Setup

---

### **F5 Example: Move the cursor forward and send the data**



1234567890ABCDEFGHIJ

Move the cursor forward 3 characters, then send the rest of the barcode data from the barcode above. End with a carriage return.

Command string: **F503F10D**

F5 is the “Move the cursor forward a number of characters” command

03 is the number of characters to move the cursor

F1 is the “Send all characters” command

0D is the hex value for a CR

The data is output as: **4567890ABCDEFGHIJ**

**<CR>**

### **F6 Move the cursor backward a number of characters**

Syntax=F6nn (nn: The numeric value (00-99) for the number of characters the cursor should be moved back)

Move the cursor back “nn” characters from current cursor position.

### **F7 Move the cursor to the beginning**

Syntax=F7

Move the cursor to the first character in the input message.

### **EA Move the cursor to the end**

Syntax=EA

Move the cursor to the last character in the input message.



@SETUPE0

\*\* Exit Setup



@SETUPE1

Enter Setup

---

## Search Commands

### F8 Search forward for a character

Syntax = F8xx (xx: The search character's hex value)

Search the input message forward for "xx" character from the current cursor position, leaving the cursor pointing to the "xx" character.

### F8 Example: Send barcode data that starts after a particular character



1234567890ABCDEFGHIJ

Search for the letter "D" in barcodes and send all the data that follows, including the "D". Using the barcode above:

Command string: **F844F10D**

F8 is the "Search forward for a character" command

44 is the hex value for "D"

F1 is the "Send all characters" command

0D is the hex value for a CR

The data is output as: **DEFGHIJ**

**<CR>**

### F9 Search backward for a character

Syntax = F9xx (xx: The search character's hex value)

Search the input message backward for "xx" character from the current cursor position, leaving the cursor pointing to the "xx" character.



@SETUPE0

\*\* Exit Setup





@SETUPE1

Enter Setup

---

### B0 Search forward for a string

Syntax=B0nnnnS (nnnn: The string length (up to 9999); S: The ASCII hex value of each character in the string)

Search forward for “S” string from the current cursor position, leaving cursor pointing to “S” string. For example, B0000454657374 will search forward for the first occurrence of the 4-character string “Test.”

### B0 Example: Send barcode data that starts after a string of characters



1234567890ABCDEFGHIJ

Search for the letters “FGH” in barcodes and send all the data that follows, including “FGH.” Using the barcode above:

Command string: **B00003464748F10D**

B0 is the “Search forward for a string” command

0003 is the string length (3 characters)

46 is the hex value for “F”

47 is the hex value for “G”

48 is the hex value for “H”

F1 is the “Send all characters” command

0D is the hex value for a CR

The data is output as: **FGHIJ**

**<CR>**

### B1 Search backward for a string

Syntax=B1nnnnS (nnnn: The string length (up to 9999); S: The ASCII hex value of each character in the string)

Search backward for “S” string from the current cursor position, leaving cursor pointing to “S” string. For example, B1000454657374 will search backward for the first occurrence of the 4-character string “Test.”



@SETUPE0

\*\* Exit Setup



@SETUPE1

Enter Setup

---

### E6 Search forward for a non-matching character

Syntax=E6xx (xx: The search character's hex value)

Search the input message forward for the first non-"xx" character from the current cursor position, leaving the cursor pointing to the non-"xx" character.

### E6 Example: Remove zeros at the beginning of barcode data



0000123abc

This example shows a barcode that has been zero filled. You may want to ignore the zeros and send all the data that follows. E6 searches forward for the first character that is not zero, then sends all the data after, followed by a carriage return. Using the barcode above:

Command string: **E630F10D**

E6 is the "Search forward for a non-matching character" command

30 is the hex value for 0

F1 is the "Send all characters" command

0D is the hex value for a CR

The data is output as: **123abc**

**<CR>**

### E7 Search backward for a non-matching character

Syntax=E7xx(xx: The search character's hex value)

Search the input message backward for the first non-"xx" character from the current cursor position, leaving the cursor pointing to the non-"xx" character.



@SETUPE0

\*\* Exit Setup



@SETUPE1

Enter Setup

## Comparison Command

### B2 string is compared with B@

Syntax= B2nnnnSS1SSn (nnnn: the length of character string, SS1- SSn: the hex value of character string)

The comparison starts from the right side of the current cursor position, and the cursor moves nnnn characters to the right. If the string within the cursor movement range is equal to SS1SSn, the instruction continues to execute; otherwise, it exits.

### B2 example: Send data after the specified string of character



Test123456

The above barcode starts with the "Test" string, and requires the content of the Test string to be sent, and finally a carriage return.

Command string: B2000454657374F10D

B2 is the comparison of the character string" command

0004 is the string length (4 characters)

54 is the hex value for T

65 is the hex value for e

73 is the hex value for s

74 is the hex value for t

F1 is the "Send all characters" command

0D is the hex value of carriage return

The data is output as 123456<CR>

### EC Check if the character to the right of the cursor is number

This command takes no parameters. If the right side of the cursor is a non-numeric, the current command is exited, otherwise execution continues.

### EC example: Send barcode data that starts with number characters



0000123abc

The above barcode starts with number characters, requires to send barcode data, and finally sends a carriage return

Command string: ECF10D

EC is the "Check if the character to the right of the cursor is a number" command

F1 is the "Send All Characters" command

0D is the hex value for CR

The data is output as 0000123abc<CR>



@SETUPE0

\*\* Exit Setup



@SETUPE1

## Enter Setup

### ED Check if the character to the right of the cursor is non-numeric

This command takes no parameters. If the right side of the cursor is a number, the current command is exited, otherwise execution continues.

#### ED example: Send barcode data that starts with non-numeric characters



Test123456

The above barcode starts with non-numeric characters, requires to send barcode data, and finally sends a carriage return

Command string: EDF10D

EC is the "Check if the character to the right of the cursor is a number" command

F1 is the "Send All Characters" command

0D is the hex value of carriage return

The data is output as Test123456 <CR>

### FE Character Comparison

Syntax = FExx (xx is the hex value of the character)

If the character to the right of the current cursor position is xx, execution continues; otherwise exit.

#### FE example: The example is a barcode that starts with the character "1" and send the first 6 bytes of the barcode.



1234567890ABCDEFGHIJ

The above barcode starts with the character "1", and requires to send the character "1" and the next 5 characters

Command string: FE31F7F2060D

FE is the "Character Compare" command

31 is the hex of the character "1"

F7 is the "Move cursor to starting position" command

F2 is the "Send several characters" command

06 is the "Send character length"

0D is the hex value of carriage return

The data is output as 123456 <CR>



@SETUPE0

## \*\* Exit Setup



@SETUPE1

Enter Setup

---

## Miscellaneous Commands

### FB Suppress characters

Syntax = FBnnxxyy..zz (nn: The numeric value (00-15) for the number of suppressed characters; xxyy..zz: The hex value of the characters to be suppressed)

Suppress all occurrences of up to 15 different characters, starting at the current cursor position, as the cursor is advanced by other commands.

### FB Example: Remove spaces in barcode data



12 34\_5\*6 78

This example shows a barcode that has spaces in the data. You may want to remove the spaces before sending the data. Using the barcode above:

Command string: **FB0120F10D**

FB is the "Suppress characters" command

01 is the number of the characters to be suppressed

20 is the hex value for a space

F1 is the "Send all characters" command

0D is the hex value for a CR

The data is output as: **1234\_5\*678**

<CR>

### E4 Replace characters

Syntax = E4nnxx<sub>1</sub>xx<sub>2</sub>yy<sub>1</sub>yy<sub>2</sub>...zz<sub>1</sub>zz<sub>2</sub>(nn: The total count of the number of characters (characters to be replaced plus replacement characters; xx<sub>1</sub>: The characters to be replaced, xx<sub>2</sub>: The replacement characters, continuing through zz<sub>1</sub> and zz<sub>2</sub>)

Replace up to 15 characters in the output message, without moving the cursor.



@SETUPE0

\*\* Exit Setup



@SETUPE1

**Enter Setup**

---

**E4 Example: Replace zeros with CRs in barcode data**



12304560780AB

If the barcode has characters that the host application does not want included, you can use the E4 command to replace those characters with something else. In this example, you will replace the zeros in the barcode above with carriage returns.

Command string: **E402300DF10D**

E4 is the "Replace characters" command

02 is the total count of characters to be replaced, plus the replacement characters (0 is replaced by CR, so total characters=2)

30 is the hex value for 0

0D is the hex value for a CR (the character that will replace the 0)

F1 is the "Send all characters" command

0D is the hex value for a CR

The data is output as: **123**

**456**

**78**

**AB**

**<CR>**



@SETUPE0

**\*\* Exit Setup**



@SETUPE1

Enter Setup

---

### BA Replace a string with another

Syntax = BAnnNN<sub>1</sub>SS<sub>1</sub>NN<sub>2</sub>SS<sub>2</sub>

nn: The count of replacements to be made, if nn=00 or nn>= the number of occurrences of a string to be replaced, then replace all occurrences of that string.

NN<sub>1</sub>: The length of the string to be replaced, NN<sub>1</sub>>0.

SS<sub>1</sub>: The ASCII hex value of each character in the string to be replaced.

NN<sub>2</sub>: The length of replacement string, NN<sub>2</sub>>=0. To replace string "SS<sub>1</sub>" with NUL (i.e. delete string "SS<sub>1</sub>"), you should set NN<sub>2</sub> to 00 and leave out SS<sub>2</sub>.

SS<sub>2</sub>: The ASCII hex value of each character in the replacement string.

From the current cursor position, search forward for the occurrence of "SS<sub>1</sub>" string (of length "NN<sub>1</sub>") and replace the string with "SS<sub>2</sub>" string (of length "NN<sub>2</sub>") in the output message until every "SS<sub>1</sub>" string is replaced or the count of replacements made reaches "nn" times, without moving the cursor.

### BA Example: Replace "23"s with "ABC"s in barcode data



1234Abc23R0123U

If the barcode has a string of characters that the host application does not want included, you can use the BA command to replace the string with something else. In this example, you will replace the "23"s in the barcode above with "ABC"s.

Command string: **BA0002323303414243F100**

BA is the "Replace a string with another" command

00 is the count of replacements to be made, 00 means to replace all occurrences of that string

02 is the length of the string to be replaced

32 is the hex value for 2 (character in the string to be replaced)

33 is the hex value for 3 (character in the string to be replaced)

03 is the length of the replacement string



@SETUPE0

\*\* Exit Setup



@SETUPE1

## Enter Setup

---

41 is the hex value for A (character in the replacement string)

42 is the hex value for B (character in the replacement string)

43 is the hex value for C (character in the replacement string)

F1 is the "Send all characters" command

00 is the hex value for a NUL

The data is output as: **1ABC4AbcABCR01ABCU**

### **BA Example: Remove only the first occurrence of "23"s in barcode data**

If the barcode has a string of characters that the host application wants removed, you can use the BA command to replace the string with NUL. In this example, you will remove the first occurrence of "23" in the barcode above.

Command string: **BA0102323300F100**

BA is the "Replace a string with another" command

01 is the count of replacements to be made

02 is the length of the string to be replaced

32 is the hex value for 2 (character in the string to be replaced)

33 is the hex value for 3 (character in the string to be replaced)

00 is the length of the replacement string, 00 means to replace the string to be replaced with NUL

F1 is the "Send all characters" command

00 is the hex value for a NUL

The data is output as: **14Abc23R0123U**



@SETUPE0

## \*\* Exit Setup





@SETUPE1

Enter Setup

---

### EF Insert a delay

Syntax=EFnnnn (nnnn: The delay in 5ms increments, up to 9999)

Inserts a delay of up to 49,995 milliseconds (in multiples of 5), starting from the current cursor position. This command can only be used with USB HID Keyboard.

### EF Example: Insert a delay of 1s between the 5<sup>th</sup> and 6<sup>th</sup> character

Send the first 5 characters in a barcode, wait for 1s, then send the rest of the barcode data.

Command string: **F20500EF0200E900**

F2 is the "Send a number of characters" command

05 is the number of characters to send

00 is the hex value for a Null character

EF is the "Insert a delay" command

0200 is the delay value (5msX200=1000ms=1s)

E9 is the "Send all but the last characters" command

00 is the number of characters that will not be sent at the end of the message



@SETUPE0

\*\* Exit Setup



@SETUPE1

**Enter Setup**

---

**B5 Insert key strokes**

Syntax=B5nnssxx (nn: The number of keys pressed (without key modifiers); ss: the key modifier from the table below; xx: the key number from the “Unicode Key Maps” in Appendix.)

Insert a key stroke or combination of key strokes. Key strokes are dependent on your keyboard (see the “Unicode Key Maps” in Appendix). This command can only be used with USB HID Keyboard.

| Key Modifiers   |    |
|-----------------|----|
| No Key Modifier | 00 |
| Shift Left      | 01 |
| Shift Right     | 02 |
| Alt Left        | 04 |
| Alt Right       | 08 |
| Control Left    | 10 |
| Control Right   | 20 |

For example, B501001F inserts an “a” on a U.S. style keyboard. B5 = the command, 01 = number of keys pressed (without the key modifier), 00 is No Key Modifier, and 1F is the “a” key. If an “A” were to be inserted, B501011F or B501021F would be entered.

If there are two keystrokes, the syntax would change from Syntax=B5nnssxx for one keystroke to Syntax=B5nnssxxssxx. An example that would insert “aA” is as follows: B502001F011F.

Note: Key modifiers can be added together when needed. Example: Shift Left + Alt Left + Control Left =15.



@SETUPE0

**\*\* Exit Setup**



@SETUPE1

Enter Setup

## Chapter 9 Prefix&Suffix

### Introduction

A 1D barcode could contain digits, letters, symbols, etc. A 2D barcode could contain more data, such as Chinese characters and other multi-byte characters. However, in real applications, they do not and should not have all information we need, such as barcode type, data acquisition time and delimiter, in order to keep the barcodes short and flexible.

Prefix and suffix are how to fulfill the needs mentioned above. They can be added, removed and modified while the original barcode data remains intact.



Barcode processing procedure:

1. Edit data with Data Formatter
2. Append prefix/suffix
3. Pack data
4. Append terminating character



@SETUPE0

\*\* Exit Setup



@SETUPE1  
Enter Setup

## Global Settings

### Enable/Disable All Prefixes/Suffixes

**Disable All Prefixes/Suffixes:** Transmit barcode data with no prefix/suffix.

**Enable All Prefixes/Suffixes:** Allow to append Code ID prefix, AIM ID prefix, custom prefix/suffix and terminating character to the barcode data before the transmission.



@APSENA0  
Disable All Prefixes/Suffixes



@APSENA1  
Enable All Prefixes/Suffixes

## Prefix Sequence



@PRESEQ0  
\*\* Code ID+ Custom +AIM ID



@PRESEQ1  
Custom + Code ID + AIM ID



@SETUPE0  
\*\* Exit Setup



@SETUPE1

**Enter Setup**

## Custom Prefix

### Enable/Disable Custom Prefix

If custom prefix is enabled, you are allowed to append to the data a user-defined prefix that cannot exceed 10 characters. For example, if the custom prefix is “AB” and the barcode data is “123”, the Host will receive “AB123”.



@CPRENA0

**\*\* Disable Custom Prefix**



@CPRENA1

**Enable Custom Prefix**

### Set Custom Prefix

To set a custom prefix, scan the **Set Custom Prefix** barcode then the numeric barcodes corresponding to the hexadecimal value of a desired prefix then the **Save** barcode.

**Note:** A custom prefix cannot exceed 10 characters.



@CPRSET

**Set Custom Prefix**

**Set the custom prefix to “CODE” (HEX: 0x43/0x4F/0x44/0x45):**

**E**  
*xample*

1. Scan the **Enter Setup** barcode.
2. Scan the **Set Custom Prefix** barcode.
3. Scan the numeric barcodes “4”, “3”, “4”, “F”, “4”, “4”, “4” and “5” from the “Digit Barcodes” section in Appendix.
4. Scan the **Save** barcode from the “Save/Cancel Barcodes” section in Appendix.
5. Scan the **Enable Custom Prefix** barcode.
6. Scan the **Exit Setup** barcode.



@SETUPE0

**\*\* Exit Setup**



@SETUPE1

**Enter Setup**

---

## AIM ID Prefix

AIM (Automatic Identification Manufacturers) ID defines symbology identifier (For the details, see the “AIM ID Table” section in Appendix). If AIM ID prefix is enabled, the scanner will add the symbology identifier before the scanned data after decoding.



@AIDENA0

**\*\* Disable AIM ID Prefix**



@AIDENA1

**Enable AIM ID Prefix**



AIM ID is not user programmable.



@SETUPE0

**\*\* Exit Setup**



@SETUPE1

**Enter Setup**

---

## Code ID Prefix

Code ID can also be used to identify barcode type. Unlike AIM ID, Code ID is user programmable. Code ID can only consist of one or two English letters.



@CIDENA0

**\*\* Disable Code ID Prefix**



@CIDENA1

**Enable Code ID Prefix**

## Restore All Default Code IDs

For the information of default Code IDs, see the "Code ID Table" section in Appendix.



@CIDDEF

**Restore All Default Code IDs**

## Modify Code ID

See the examples below to learn how to modify a Code ID and restore the default Code IDs of all symbologies.



@SETUPE0

**\*\* Exit Setup**



@SETUPE1

**Enter Setup**

---

**E**  
*sample*

**Modify PDF417 Code ID to be “p” (HEX: 0x70):**

1. Scan the **Enter Setup** barcode.
2. Scan the **Modify PDF417 Code ID** barcode.
3. Scan the numeric barcodes “7” and “0” from the “Digit Barcodes” section in Appendix.
4. Scan the **Save** barcode from the “Save/Cancel Barcodes” section in Appendix.
5. Scan the **Exit Setup** barcode.

**Restore the default Code IDs of all symbologies:**

1. Scan the **Enter Setup** barcode.
2. Scan the **Restore All Default Code IDs** barcode.
3. Scan the **Exit Setup** barcode.



@SETUPE0

**\*\* Exit Setup**





@SETUPE1

**Enter Setup**

---

**1D symbologies:**



@CID002

**Modify Code 128 Code ID**



@CID003

**Modify GS1-128 Code ID**



@CID004

**Modify EAN-8 Code ID**



@CID005

**Modify EAN-13 Code ID**



@CID006

**Modify UPC-E Code ID**



@CID007

**Modify UPC-A Code ID**



@CID008

**Modify Interleaved 2 of 5 Code ID**



@SETUPE0

**\*\* Exit Setup**



@SETUPE1

**Enter Setup**

---



@CID009

**Modify ITF-14 Code ID**



@CID010

**Modify ITF-6 Code ID**



@CID011

**Modify Matrix 2 of 5 Code ID**



@CID013

**Modify Code 39 Code ID**



@CID015

**Modify Codabar Code ID**



@CID017

**Modify Code 93 Code ID**



@CID019

**Modify China Post 25 Code ID**



@CID020

**Modify AIM 128 Code ID**



@SETUPE0

**\*\* Exit Setup**



@SETUPE1

**Enter Setup**

---



@CID023

**Modify ISSN Code ID**



@CID021

**Modify ISBT 128 Code ID**



@CID024

**Modify ISBN Code ID**



@CID025

**Modify Industrial 25 Code ID**



@CID026

**Modify Standard 25 Code ID**



@CID027

**Modify Plessey Code ID**



@CID028

**Modify Code 11 Code ID**



@CID029

**Modify MSI-Plessey Code ID**



@SETUPE0

**\*\* Exit Setup**



@SETUPE1

**Enter Setup**

---



@CID030

**Modify GS1 Composite Code ID**



@CID031

**Modify GS1 Databar Code ID**



@CID132

**Modify Code 49 Code ID**



@CID133

**Modify Code 16K Code ID**



@SETUPE0

**\*\* Exit Setup**



@SETUPE1

**Enter Setup**

---

**2D symbologies:**



@CID032

**Modify PDF417 Code ID**



@CID033

**Modify QR Code ID**



@CID034

**Modify Aztec Code ID**



@CID035

**Modify Data Matrix Code ID**



@CID036

**Modify Maxicode Code ID**



@CID039

**Modify Chinese Sensible Code ID**



@CID041

**Modify GM Code ID**



@SETUPE0

**\*\* Exit Setup**



@SETUPE1

**Enter Setup**

---



@CID042

**Modify Micro PDF417 Code ID**



@CID043

**Modify Micro QR Code ID**



@CID048

**Modify Code One Code ID**



@SETUPE0

**\*\* Exit Setup**



@SETUPE1

**Enter Setup**

---

**Postal symbologies:**



@CID096

**Modify USPS Postnet Code ID**



@CID098

**Modify Royal Mail Code ID**



@CID100

**Modify KIX Post Code ID**



@CID097

**Modify USPS Intelligent Mail Code ID**



@CID099

**Modify USPS Planet Code ID**



@CID101

**Modify Australian Postal Code ID**



@SETUPE0

**\*\* Exit Setup**



@SETUPE1

Enter Setup

## Custom Suffix

### Enable/Disable Custom Suffix

If custom suffix is enabled, you are allowed to append to the data a user-defined suffix that cannot exceed 10 characters. For example, if the custom suffix is “AB” and the barcode data is “123”, the Host will receive “123AB”.



@CSUENA0

\*\* Disable Custom Suffix



@CSUENA1

Enable Custom Suffix

### Set Custom Suffix

To set a custom suffix, scan the **Set Custom Suffix** barcode then the numeric barcodes corresponding to the hexadecimal value of a desired suffix then the **Save** barcode.

**Note:** A custom suffix cannot exceed 10 characters.



@CSUSET

Set Custom Suffix

**E**  
*sample*

**Set the custom suffix to “CODE” (HEX: 0x43/0x4F/0x44/0x45):**

1. Scan the **Enter Setup** barcode.
2. Scan the **Set Custom Suffix** barcode.
3. Scan the numeric barcodes “4”, “3”, “4”, “F”, “4”, “4”, “4” and “5” from the “Digit Barcodes” section in Appendix.
4. Scan the **Save** barcode from the “Save/Cancel Barcodes” section in Appendix.
5. Scan the **Enable Custom Suffix** barcode.
6. Scan the **Exit Setup** barcode.



@SETUPE0

\*\* Exit Setup





@SETUPE1

Enter Setup

---

## Data Packing

### Introduction

Data packing is designed for a specific group of users who want to have the data packed before transmission. Data packing influences data format, so it is advised to disable this feature when it is not required.

### Data Packing Options

**Disable Data Packing:** Transmit decoded data in raw format (unpacked).

**Enable Data Packing, Format 1:** Transmit decoded data with the packet format 1 defined below.

Packet format 1: [STX + ATTR + LEN] + [AL\_TYPE + DATA] + [LRC]

STX: 0x02

ATTR: 0x00

LEN: Barcode data length is expressed in 2 bytes ranging from 0x0000 (0) to 0xFFFF (65535).

AL\_TYPE: 0x36

DATA: Raw barcode data.

LRC: Check digit.

LRC calculation algorithm: computation sequence: 0xFF+LEN+AL\_TYPE+DATA; computation method is XOR, byte by byte.

**Enable Data Packing, Format 2:** Transmit decoded data with the packet format 2 defined below.

Packet format 2: [STX + ATTR + LEN] + [AL\_TYPE] + [Symbology\_ID + DATA] + [LRC]

STX: 0x02

ATTR: 0x00

LEN: Barcode data length is expressed in 2 bytes ranging from 0x0000 (0) to 0xFFFF (65535).

AL\_TYPE: 0x3B

Symbology\_ID: The ID number of symbology, 1 byte.

DATA: Raw barcode data.

LRC: Check digit.

LRC calculation algorithm: computation sequence: 0xFF+LEN+AL\_TYPE+Symbology\_ID+DATA; computation method is XOR, byte by byte.



@SETUPE0

\*\* Exit Setup



@SETUPE1

**Enter Setup**

---



@PACKAG0

**\*\* Disable Data Packing**



@PACKAG1

**Enable Data Packing, Format 1**



@PACKAG2

**Enable Data Packing, Format 2**



@SETUPE0

**\*\* Exit Setup**



@SETUPE1

Enter Setup

## Terminating Character Suffix

### Enable/Disable Terminating Character Suffix

A terminating character such as carriage return (CR) or carriage return/line feed pair (CRLF) can only be used to mark the end of data, which means nothing can be added after it.



@TSUENAO

Disable Terminating Character Suffix



@TSUENA1

\*\* Enable Terminating Character Suffix

### Set Terminating Character Suffix

To set a terminating character suffix, scan the **Set Terminating Character Suffix** barcode then the numeric barcodes corresponding to the hexadecimal value of a desired terminating character then the **Save** barcode.

**Note:** A terminating character suffix cannot exceed 2 characters.



@TSUSET

Set Terminating Character Suffix

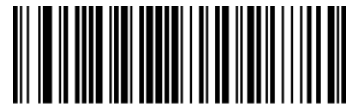

@TSUSET0D

\*\* Set Terminating Character to CR (0x0D)



@TSUSET0D0A

Set Terminating Character to CRLF (0x0D,0x0A)



@SETUPE0

\*\* Exit Setup



@SETUPE1

**Enter Setup**

---

**E**  
*sample*

**Set the terminating character suffix to 0x0A:**

1. Scan the **Enter Setup** barcode.
2. Scan the **Set Terminating Character Suffix** barcode.
3. Scan the numeric barcodes "0" and "A" from the "Digit Barcodes" section in Appendix.
4. Scan the **Save** barcode from the "Save/Cancel Barcodes" section in Appendix.
5. Scan the **Enable Terminating Character Suffix** barcode.
6. Scan the **Exit Setup** barcode.



@SETUPE0

**\*\* Exit Setup**



@SETUPE1

Enter Setup

## Chapter 10 Batch Programming

### Introduction

Batch programming enables users to integrate a batch of commands into a single batch barcode.

Listed below are batch programming rules:

1. Command format: Command + Parameter Value.
2. Each command is terminated by a semicolon (;). Note that there is no space between a command and its terminator semicolon.
3. Use the barcode generator software to generate a 2D batch barcode.

Example: Create a batch barcode for **Normal Illumination, Sense Mode, Decode Session Timeout = 2s, Disable Interleaved 2 of 5:**

1. Input the commands:

@ILLSCN1;SCNMOD2;ORTSET2000;I25ENA0;

2. Generate a batch barcode.

When setting up a scanner with the above configuration, scan the **Enable Batch Barcode** barcode and then the batch barcode generated.



@BATCHS

**Enable Batch Barcode**



@SETUPE0

**\*\* Exit Setup**



@SETUPE1

Enter Setup

---

## Create a Batch Command

A batch command may contain a number of individual commands each of which is terminated by a semicolon (;). For more information, refer to the “Use of Programming Command” section in Chapter 3.

## Create a Batch Barcode

Batch barcodes can be produced in the format of PDF417, QR Code or Data Matrix.

Example: Create a batch barcode for **Normal Illumination, Sense Mode, Decode Session Timeout = 2s, Disable Interleaved 2 of 5**:

1. Input the following commands:

```
@ILLSCN1;SCNMOD2;ORTSET2000;I25E
```

```
NA0;
```

2. Generate a PDF417 batch barcode.



@SETUPE0

\*\* Exit Setup



## Use Batch Barcode

To put a batch barcode into use, scan the following barcodes. (Use the example above.)

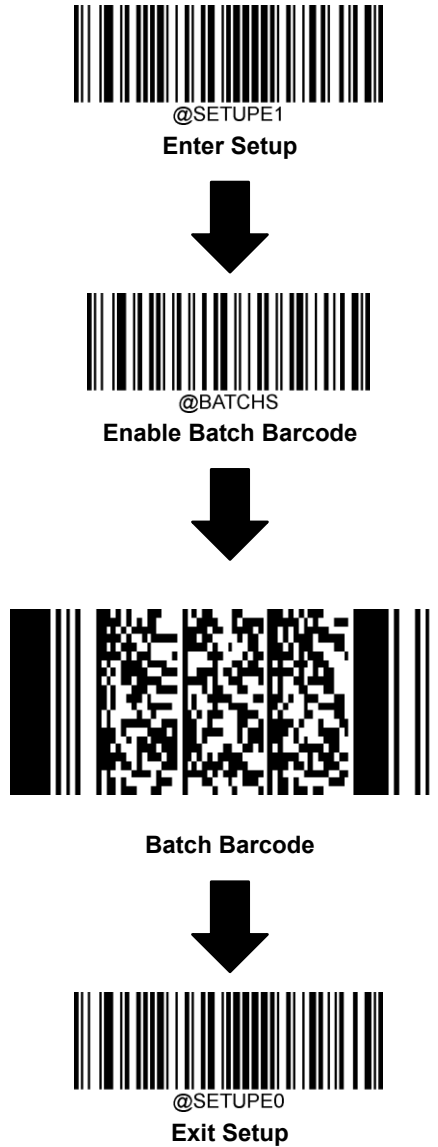

# Appendix

## Digit Barcodes

0~9







@DIGIT6

**6**



@DIGIT7

**7**



@DIGIT8

**8**



@DIGIT9

**9**

A~F



@DIGITA

A



@DIGITB

B



@DIGITC

C



@DIGITD

D



@DIGITE

E



@DIGITF

F

---

## Save/Cancel Barcodes

After reading numeric barcode(s), you need to scan the **Save** barcode to save the data. If you scan the wrong digit(s), you can either scan the **Cancel** barcode and then start the configuration all over again, or scan the **Delete the Last Digit** barcode and then the correct digit, or scan the **Delete All Digits** barcode and then the digits you want.

For instance, after reading the **Maximum Length** barcode and numeric barcodes “1”, “2” and “3”, you scan:

- ❖ **Delete the Last Digit:** The last digit “3” will be removed.
- ❖ **Delete All Digits:** All digits “123” will be removed.
- ❖ **Cancel:** The maximum length configuration will be cancelled. And the scanner is still in the setup mode.



## Factory Defaults Table

| Parameter                                  | Factory Default       | Remark                     |
|--|-----------------------|----------------------------|
| Barcode Programming                        | Disabled (Exit Setup) |                            |
| Programming Barcode Data                   | Do not transmit       |                            |
| Illumination                               | On                    |                            |
| Aiming                                     | Normal                |                            |
| Good Read LED                              | On                    |                            |
| Good Read LED Duration                     | Short (20ms)          |                            |
| Power On Beep                              | On                    |                            |
| Good Read Beep                             | On                    |                            |
| Good Read Beep Duration                    | Medium (80ms)         |                            |
| Good Read Beep Frequency                   | Medium (2730Hz)       |                            |
| Good Read Beep Volume                      | Loud                  |                            |
| Do Not Disturb Mode                        | Turn Off              |                            |
| Turn On/Off Do Not Disturb Mode by Trigger | Turn Off              |                            |
| Scan Mode                                  | Level Mode            |                            |
| Decode Session Timeout                     | 3,000ms               | 1-3,600,000ms; 0: Infinite |
| Image Stabilization Timeout (Sense Mode)   | 200ms                 | 0-3,000ms                  |
| Reread Timeout                             | Disabled              |                            |
| Image Stabilization Timeout (Sense Mode)   | 1,500ms               | 1-3,600,000ms              |
| Reset Reread Timeout                       | Off                   |                            |
| Image Decoding Timeout                     | 500ms                 | 1-3,000ms                  |
| Image Decoding Preference                  | Paper Barcodes        |                            |
| Surround GS1 AI's with Parentheses         | Off                   |                            |
| Transmit GS1 check character               | Enable                |                            |
| Sensitivity                                | Medium (11)           |                            |
| Scanning Preference                        | Normal Mode           |                            |
| Read Barcode                               | On                    |                            |
| Smart Stand Mode                           | On                    |                            |
| Decode Area                                | Whole Area Decoding   |                            |
| Image Flipping                             | Do Not Flip           |                            |
| Bad Read Message                           | Off                   |                            |
| Send Bad Read Message                      | NG                    | 1-7 characters             |
| Auto Power-Off Timeout                     | 5 minutes             |                            |

---

|                   |                  |  |
|-------------------|------------------|--|
| Default Interface | USB HID Keyboard |  |
|-------------------|------------------|--|

| <b>Wireless Communications</b>            |   |                  |
|---|---|------------------|
| Operating Mode                            | Cradle Mode                               |                  |
| Batch Mode Option                         | Off                                       |                  |
| Prevent Same Barcode Storage              | Off                                       |                  |
| Batch Mode Transmit Delay                 | No Transmit Delay (0ms)                   |                  |
| End of Transmission Message               | Off, EOT                                  |                  |
| Auto Clear Stored Data after Transmission | Off                                       |                  |
| Wireless Communication Mode               | Point-to-Point Mode                       |                  |
| Scanner Time                              | Set Date and Time                         |                  |
| Time Stamp                                | Do Not Send                               |                  |
| Time Stamp Format                         | Format 1: (YYYY/MM/DD,HH:MM:SS)           |                  |
| Host Acknowledgement                      | Off                                       |                  |
| Host Acknowledgement Timeout              | 1 Second                                  |                  |
| Host Acknowledgement Beep Volume          | Loud                                      |                  |
| <b>RS-232 Interface</b>                   |   |                  |
| Baud Rate                                 | 115200                                    |                  |
| Parity Check                              | None                                      |                  |
| Data Bits                                 | 8   |                  |
| Stop Bits                                 | 1   |                  |
| <b>USB Interface</b>                      |   |                  |
| USB Country Keyboard                      | US keyboard                               | USB HID Keyboard |
| Emulate ALT+Keypad                        | Off                                       | USB HID Keyboard |
| Code Page                                 | Code Page 1252 (West European Latin)      | USB HID Keyboard |
| Function Key Mapping                      | Disable                                   | USB HID Keyboard |
| Inter-Keystroke Delay                     | No Delay                                  | USB HID Keyboard |
| Caps Lock                                 | Off                                       |                  |
| Convert Case                              | No Case Conversion                        | USB HID Keyboard |
| Emulate Numeric Keypad 1                  | Off                                       | USB HID Keyboard |
| Emulate Numeric Keypad 2                  | Off                                       | USB HID Keyboard |
| Polling Rate                              | 4ms                                       | USB HID Keyboard |
| KBW Communication                         | On  |                  |
| <b>Symbologies</b>                        |   |                  |
| <b>Global Settings</b>                    |   |                  |
| Surround GS1 AI's with Parentheses        | Do Not Surround GS1 AI's with Parentheses |                  |

| <b>Code 128</b>                                    |                            |  |
|--|----------------------------|--|
| Code 128   | Enabled                    |  |
| Maximum Length                                     | 48                         |  |
| Minimum Length                                     | 1                          |  |
| <b>EAN-8</b>                                       |                            |  |
| EAN-8  | Enabled                    |  |
| Check Character                                    | Transmit                   |  |
| 2-Digit Add-On Code                                | Disabled                   |  |
| 5-Digit Add-On Code                                | Disabled                   |  |
| Add-on Code  | Not Required               |  |
| Convert EAN-8 to EAN-13                            | Disabled                   |  |
| <b>EAN-13</b>                                      |                            |  |
| EAN-13   | Enabled                    |  |
| Check Character                                    | Transmit                   |  |
| 2-Digit Add-On Code                                | Disabled                   |  |
| 5-Digit Add-On Code                                | Disabled                   |  |
| Add-On Code  | Not Required               |  |
| EAN-13 Beginning with 290 Add-On Code Required     | Do Not Require Add-On Code |  |
| EAN-13 Beginning with 378/379 Add-On Code Required | Do Not Require Add-On Code |  |
| EAN-13 Beginning with 414/419 Add-On Code Required | Do Not Require Add-On Code |  |
| EAN-13 Beginning with 434/439 Add-On Code Required | Do Not Require Add-On Code |  |
| EAN-13 Beginning with 977 Add-On Code Required     | Do Not Require Add-On Code |  |
| EAN-13 Beginning with 978 Add-On Code Required     | Do Not Require Add-On Code |  |
| EAN-13 Beginning with 979 Add-On Code Required     | Do Not Require Add-On Code |  |
| <b>UPC-E</b>                                       |                            |  |
| UPC-E0   | Enabled                    |  |
| UPC-E1   | Disabled                   |  |
| Check Character                                    | Transmit                   |  |
| 2-Digit Add-On Code                                | Disabled                   |  |

|  |  |  |
|--|--|--|
| 5-Digit Add-On Code                    | Disabled                                       |  |
| Add-on Code                            | Not Required                                   |  |
| Transmit Preamble Character            | No Preamble                                    |  |
| Convert UPC-E to UPC-A                 | Disabled                                       |  |
| <b>UPC-A</b>                           |  |  |
| UPC-A                                  | Enabled  |  |
| Check Character                        | Transmit                                       |  |
| 2-Digit Add-On Code                    | Disabled                                       |  |
| 5-Digit Add-On Code                    | Disabled                                       |  |
| Transmit Preamble Character            | System Character                               |  |
| <b>Coupon</b>                          |  |  |
| UPC-A/EAN-13 with Extended Coupon Code | Disabled                                       |  |
| Coupon GS1 DataBar Output              | Disabled                                       |  |
| <b>Interleaved 2 of 5</b>              |  |  |
| Interleaved 2 of 5                     | Enabled  |  |
| Maximum Length                         | 80   |  |
| Minimum Length                         | 6  |  |
| Check Character Verification           | Do not transmit check digit after verification |  |
| <b>Febraban</b>                        |  |  |
| Febraban                               | Enabled, do not expand                         |  |
| Transmit Delay per Character           | Disabled                                       |  |
|  | 70ms   |  |
| Transmit Delay per 12 Characters       | Disabled                                       |  |
|  | 500ms  |  |
| <b>ITF-14</b>                          |  |  |
| ITF-14                                 | Disabled                                       |  |
| <b>ITF-6</b>                           |  |  |
| ITF-6                                  | Disabled                                       |  |
| <b>Matrix 2 of 5</b>                   |  |  |
| Matrix 2 of 5                          | Enabled  |  |
| Maximum Length                         | 80   |  |
| Minimum Length                         | 4  |  |
| Check Character Verification           | Disabled                                       |  |
| <b>Code 39</b>                         |  |  |
| Code 39                                | Enabled  |  |



|                                |  |  |
|--------------------------------|--|--|
| Maximum Length                 | 48   |  |
| Minimum Length                 | 1  |  |
| Check Character Verification   | Disabled   |  |
| Start/Stop Character           | Do not transmit                                    |  |
| Code 39 Full ASCII             | Disabled   |  |
| Code 32 Pharmaceutical (PARAF) | Disabled   |  |
| Code 32 Prefix                 | Disabled   |  |
| Code 32 Start/Stop Character   | Do not transmit                                    |  |
| Code 32 Check Character        | Do not transmit                                    |  |
| <b>Codabar</b>                 |  |  |
| Codabar                        | Enabled  |  |
| Maximum Length                 | 60   |  |
| Minimum Length                 | 2  |  |
| Check Character Verification   | Disabled   |  |
| Start/Stop Character           | Do not transmit                                    |  |
|                                | ABCD/ABCD  |  |
| <b>Code 93</b>                 |  |  |
| Code 93                        | Enabled  |  |
| Maximum Length                 | 48   |  |
| Minimum Length                 | 1  |  |
| Check Character Verification   | Do Not Transmit Check Character After Verification |  |
| <b>China Post 25</b>           |  |  |
| China Post 25                  | Disabled   |  |
| Maximum Length                 | 48   |  |
| Minimum Length                 | 1  |  |
| Check Character Verification   | Disabled   |  |
| <b>GS1-128 (UCC/EAN-128)</b>   |  |  |
| GS1-128                        | Enabled  |  |
| Maximum Length                 | 48   |  |
| Minimum Length                 | 1  |  |
| <b>GS1 Databar</b>             |  |  |
| GS1 Databar                    | Enabled  |  |
| Application Identifier "01"    | Transmit   |  |
| <b>EAN•UCC Composite</b>       |  |  |
| GS1 Composite                  | Disabled   |  |

|                              |                            |  |
|------------------------------|----------------------------|--|
| UPC/EAN Composite            | Disabled                   |  |
| <b>Code 11</b>               |                            |  |
| Code 11                      | Enabled                    |  |
| Maximum Length               | 48                         |  |
| Minimum Length               | 4                          |  |
| Check Character Verification | One Check Character, MOD11 |  |
| Check Character              | Transmit                   |  |
| <b>ISBN</b>                  |                            |  |
| ISBN                         | Disabled                   |  |
| Set ISBN Format              | ISBN-10                    |  |
| <b>ISSN</b>                  |                            |  |
| ISSN                         | Disabled                   |  |
| <b>Industrial 25</b>         |                            |  |
| Industrial 25                | Enabled                    |  |
| Maximum Length               | 48                         |  |
| Minimum Length               | 6                          |  |
| Check Character Verification | Disabled                   |  |
| <b>Standard 25</b>           |                            |  |
| Standard 25                  | Enabled                    |  |
| Maximum Length               | 48                         |  |
| Minimum Length               | 6                          |  |
| Check Character Verification | Disabled                   |  |
| <b>Plessey</b>               |                            |  |
| Plessey                      | Disabled                   |  |
| Maximum Length               | 48                         |  |
| Minimum Length               | 4                          |  |
| Check Character Verification | Disabled                   |  |
| <b>MSI-Plessey</b>           |                            |  |
| MSI-Plessey                  | Disabled                   |  |
| Maximum Length               | 48                         |  |
| Minimum Length               | 4                          |  |
| Check Character Verification | One Check Character, MOD10 |  |
| Check Character              | Transmit                   |  |
| <b>AIM 128</b>               |                            |  |
| AIM 128                      | Enabled                    |  |

|                      |                                     |  |
|----------------------|-------------------------------------|--|
| Maximum Length       | 48                                  |  |
| Minimum Length       | 1                                   |  |
| <b>ISBT 128</b>      |                                     |  |
| ISBT 128             | Disabled                            |  |
| <b>Code 49</b>       |                                     |  |
| Code 49              | Disabled                            |  |
| Maximum Length       | 80                                  |  |
| Minimum Length       | 1                                   |  |
| <b>Code 16K</b>      |                                     |  |
| Code 16K             | Disabled                            |  |
| Maximum Length       | 80                                  |  |
| Minimum Length       | 1                                   |  |
| <b>PDF417</b>        |                                     |  |
| PDF417               | Enabled                             |  |
| Maximum Length       | 2710                                |  |
| Minimum Length       | 1                                   |  |
| PDF417 Twin Code     | Single PDF417 Only                  |  |
| PDF417 Inverse       | Decode Regular PDF417 Barcodes Only |  |
| Character Encoding   | Default Character Encoding          |  |
| PDF417 ECI Output    | Enabled                             |  |
| <b>Micro PDF417</b>  |                                     |  |
| Micro PDF417         | Disabled                            |  |
| Maximum Length       | 366                                 |  |
| Minimum Length       | 1                                   |  |
| <b>QR Code</b>       |                                     |  |
| QR Code              | Enabled                             |  |
| Maximum Length       | 7089                                |  |
| Minimum Length       | 1                                   |  |
| QR Twin Code         | Single QR Only                      |  |
| QR Inverse           | Decode Regular QR Barcodes Only     |  |
| Character Encoding   | Default Character Encoding          |  |
| QR ECI Output        | Enabled                             |  |
| <b>Micro QR Code</b> |                                     |  |
| Micro QR             | Enabled                             |  |
| Maximum Length       | 35                                  |  |
| Minimum Length       | 1                                   |  |

|                                 |   |  |
|---------------------------------|---|--|
| <b>Aztec</b>                    |   |  |
| Aztec Code                      | Disabled                                      |  |
| Maximum Length                  | 3832  |  |
| Minimum Length                  | 1   |  |
| Read Multi-barcodes on an Image | Mode 1  |  |
| Set the Number of Barcodes      | 1   |  |
| Character Encoding              | Default Character Encoding                    |  |
| Aztec ECI Output                | Enabled                                       |  |
| <b>Data Matrix</b>              |   |  |
| Data Matrix                     | Enabled                                       |  |
| Maximum Length                  | 3116  |  |
| Minimum Length                  | 1   |  |
| Data Matrix Twin Code           | Single Data Matrix Only                       |  |
| Rectangular Barcode             | Enabled                                       |  |
| Data Matrix Inverse             | Decode Regular Data Matrix Barcodes Only      |  |
| Character Encoding              | Default Character Encoding                    |  |
| Data Matrix ECI Output          | Enabled                                       |  |
| <b>Maxicode</b>                 |   |  |
| Maxicode                        | Disabled                                      |  |
| Maximum Length                  | 150   |  |
| Minimum Length                  | 1   |  |
| <b>Chinese Sensible Code</b>    |   |  |
| Chinese Sensible Code           | Disabled                                      |  |
| Maximum Length                  | 7827  |  |
| Minimum Length                  | 1   |  |
| Chinese Sensible Twin Code      | Single Chinese Sensible Code Only             |  |
| Chinese Sensible Code Inverse   | Decode Regular Chinese Sensible Barcodes Only |  |
| <b>GM Code</b>                  |   |  |
| GM                              | Disabled                                      |  |
| Maximum Length                  | 2751  |  |
| Minimum Length                  | 1   |  |
| <b>Code One</b>                 |   |  |
| Code One                        | Disabled                                      |  |
| Maximum Length                  | 3550  |  |
| Minimum Length                  | 1   |  |
| <b>USPS Postnet</b>             |   |  |

|                              |                                 |  |
|------------------------------|---------------------------------|--|
| USPS Postnet                 | Disabled                        |  |
| Check Character              | Transmit                        |  |
| <b>USPS Intelligent Mail</b> |                                 |  |
| USPS Intelligent Mail        | Disabled                        |  |
| <b>Royal Mail</b>            |                                 |  |
| Royal Mail                   | Disabled                        |  |
| <b>USPS Planet</b>           |                                 |  |
| USPS Planet                  | Disabled                        |  |
| Check Character              | Transmit                        |  |
| <b>KIX Post</b>              |                                 |  |
| KIX Post                     | Disabled                        |  |
| <b>Australian Postal</b>     |                                 |  |
| Australian Postal            | Disabled                        |  |
| <b>Passport OCR</b>          |                                 |  |
| Passport OCR                 | Disabled                        |  |
| <b>Data Formatter</b>        |                                 |  |
| Data Formatter               | Disabled                        |  |
| Non-Match Error Beep         | On                              |  |
| Data Format Selection        | Format_0                        |  |
| <b>Prefix &amp; Suffix</b>   |                                 |  |
| All Prefixes/Suffixes        | Disabled                        |  |
| Prefix Sequence              | Code ID+ Custom +AIM ID         |  |
| Custom Prefix                | Disabled                        |  |
| AIM ID Prefix                | Disabled                        |  |
| Code ID Prefix               | Disabled                        |  |
| Custom Suffix                | Disabled                        |  |
| Data Packing                 | Disable Data Packing            |  |
| Terminating Character Suffix | Enabled, 0x0D (Carriage Return) |  |

## AIM ID Table

| Symbology                    | AIM ID | Possible AIM ID Modifiers (m) |
|------------------------------|--------|-------------------------------|
| Code 128                     | ]C0    |                               |
| GS1-128 (UCC/EAN-128)        | ]C1    |                               |
| EAN-8                        | ]E4    |                               |
| EAN-8 with Addon             | ]E3    |                               |
| EAN-13                       | ]E0    |                               |
| EAN-13 with Addon            | ]E3    |                               |
| UPC-E                        | ]E0    |                               |
| UPC-E with Addon             | ]E3    |                               |
| UPC-A                        | ]E0    |                               |
| UPC-A with Addon             | ]E3    |                               |
| Interleaved 2 of 5, Febraban | ]Im    | 0, 1, 3                       |
| ITF-14                       | ]Im    | 1, 3                          |
| ITF-6                        | ]Im    | 1, 3                          |
| Matrix 2 of 5                | ]X0    |                               |
| Code 39, Code 32             | ]Am    | 0, 1, 3, 4, 5, 7              |
| Codabar                      | ]Fm    | 0, 2, 4                       |
| Code 93                      | ]G0    |                               |
| China Post 25                | ]X0    |                               |
| AIM 128                      | ]C2    |                               |
| ISBT 128                     | ]C4    |                               |
| ISSN                         | ]X0    |                               |
| ISBN                         | ]X0    |                               |
| Industrial 25                | ]S0    |                               |
| Standard 25                  | ]R0    |                               |
| Plessey                      | ]P0    |                               |
| Code 11                      | ]Hm    | 0, 1, 3                       |
| MSI Plessey                  | ]Mm    | 0, 1                          |
| GS1 Composite                | ]em    | 0-3                           |
| GS1 Databar (RSS)            | ]e0    |                               |
| Code 49                      | ]T0    |                               |
| Code 16K                     | ]K0    |                               |

| Symbology             | AIM ID | Possible AIM ID Modifiers (m) |
|-----------------------|--------|-------------------------------|
| PDF417                | ]Lm    | 0-2                           |
| QR Code               | ]Qm    | 0-6                           |
| Aztec                 | ]zm    | 0-9, A-C                      |
| Data Matrix           | ]dm    | 0-6                           |
| Maxicode              | ]Um    | 0-3                           |
| Chinese Sensible Code | ]X0    |                               |
| GM                    | ]gm    | (0~9)                         |
| Micro PDF417          | ]L0    |                               |
| Micro QR              | ]Q1    |                               |
| Code One              | ]X0    |                               |
| USPS Postnet          | ]X0    |                               |
| USPS Intelligent Mail | ]X0    |                               |
| Royal Mail            | ]X0    |                               |
| USPS Planet           | ]X0    |                               |
| KIX Post              | ]X0    |                               |
| Australian Postal     | ]X0    |                               |
| Passport OCR          | ]o2    |                               |

**Note:** “m” represents the AIM modifier character. Refer to ISO/IEC 15424:2008 Information technology – Automatic identification and data capture techniques – Data Carrier Identifiers (including Symbology Identifiers) for AIM modifier character details.





---

## Code ID Table

| Symbology                    | Code ID |
|------------------------------|---------|
| Code 128                     | j       |
| GS1-128 (UCC/EAN-128)        | j       |
| EAN-8                        | d       |
| EAN-13                       | d       |
| UPC-E                        | c       |
| UPC-A                        | c       |
| Interleaved 2 of 5, Febraban | e       |
| ITF-14                       | e       |
| ITF-6                        | e       |
| Matrix 2 of 5                | v       |
| Code 39, Code 32             | b       |
| Codabar                      | a       |
| Code 93                      | i       |
| China Post 25                | X       |
| AIM 128                      | X       |
| ISBT 128                     | X       |
| ISSN                         | g       |
| ISBN                         | B       |
| Industrial 25                | l       |
| Standard 25                  | f       |
| Plessey                      | n       |
| Code 11                      | H       |
| MSI Plessey                  | m       |
| GS1 Composite                | y       |
| GS1 Databar (RSS)            | R       |
| Code 49                      | X       |
| Code 16K                     | X       |
| PDF417                       | r       |
| QR Code                      | s       |
| Aztec                        | z       |
| Data Matrix                  | u       |

---

| Symbology             | Code ID |
|-----------------------|---------|
| MaxiCode              | x       |
| Chinese Sensible Code | h       |
| GM Code               | x       |
| Micro PDF417          | R       |
| Micro QR              | X       |
| Code One              | X       |
| USPS Postnet          | P       |
| USPS Intelligent Mail | M       |
| Royal Mail            | x       |
| USPS Planet           | L       |
| KIX Post              | K       |
| Australian Postal     | A       |
| Passport OCR          | O       |

---

## Symbology ID Number

| Symbology                    | ID Number |
|------------------------------|-----------|
| Code 128                     | 002       |
| GS1-128 (UCC/EAN-128)        | 003       |
| EAN-8                        | 004       |
| EAN-13                       | 005       |
| UPC-E                        | 006       |
| UPC-A                        | 007       |
| Interleaved 2 of 5, Febraban | 008       |
| ITF-14                       | 009       |
| ITF-6                        | 010       |
| Matrix 2 of 5                | 011       |
| Code 39, Code 32             | 013       |
| Codabar                      | 015       |
| Code 93                      | 017       |
| China Post 25                | 019       |
| AIM 128                      | 020       |
| ISBT 128                     | 021       |
| ISSN                         | 023       |
| ISBN                         | 024       |
| Industrial 25                | 025       |
| Standard 25                  | 026       |
| Plessey                      | 027       |
| Code11                       | 028       |
| MSI-Plessey                  | 029       |
| GS1 Composite                | 030       |
| GS1 Databar (RSS)            | 031       |
| PDF417                       | 032       |
| QR Code                      | 033       |
| Aztec                        | 034       |
| Data Matrix                  | 035       |
| Maxicode                     | 036       |
| Chinese Sensible Code        | 039       |
| GM Code                      | 040       |

---

| Symbology             | ID Number |
|-----------------------|-----------|
| Micro PDF417          | 042       |
| Micro QR              | 043       |
| Code One              | 048       |
| Passport OCR          | 066       |
| USPS Postnet          | 096       |
| USPS Intelligent Mail | 097       |
| Royal Mail            | 098       |
| USPS Planet           | 099       |
| KIX Post              | 100       |
| Australian Postal     | 101       |
| Code 49               | 132       |
| Code 16K              | 133       |

---

## ASCII Table

| HEX | Dec | Char                          |
|-----|-----|-------------------------------|
| 00  | 0   | NUL (Null char.)              |
| 01  | 1   | SOH (Start of Header)         |
| 02  | 2   | STX (Start of Text)           |
| 03  | 3   | ETX (End of Text)             |
| 04  | 4   | EOT (End of Transmission)     |
| 05  | 5   | ENQ (Enquiry)                 |
| 06  | 6   | ACK (Acknowledgment)          |
| 07  | 7   | BEL (Bell)                    |
| 08  | 8   | BS (Backspace)                |
| 09  | 9   | HT (Horizontal Tab)           |
| 0a  | 10  | LF (Line Feed)                |
| 0b  | 11  | VT (Vertical Tab)             |
| 0c  | 12  | FF (Form Feed)                |
| 0d  | 13  | CR (Carriage Return)          |
| 0e  | 14  | SO (Shift Out)                |
| 0f  | 15  | SI (Shift In)                 |
| 10  | 16  | DLE (Data Link Escape)        |
| 11  | 17  | DC1 (XON) (Device Control 1)  |
| 12  | 18  | DC2 (Device Control 2)        |
| 13  | 19  | DC3 (XOFF) (Device Control 3) |
| 14  | 20  | DC4 (Device Control 4)        |
| 15  | 21  | NAK (Negative Acknowledgment) |
| 16  | 22  | SYN (Synchronous Idle)        |
| 17  | 23  | ETB (End of Trans. Block)     |
| 18  | 24  | CAN (Cancel)                  |
| 19  | 25  | EM (End of Medium)            |
| 1a  | 26  | SUB (Substitute)              |
| 1b  | 27  | ESC (Escape)                  |

---

|    |    |                                 |
|----|----|---------------------------------|
| 1c | 28 | FS (File Separator)             |
| 1d | 29 | GS (Group Separator)            |
| 1e | 30 | RS (Request to Send)            |
| 1f | 31 | US (Unit Separator)             |
| 20 | 32 | SP (Space)                      |
| 21 | 33 | ! (Exclamation Mark)            |
| 22 | 34 | " (Double Quote)                |
| 23 | 35 | # (Number Sign)                 |
| 24 | 36 | \$ (Dollar Sign)                |
| 25 | 37 | % (Percent)                     |
| 26 | 38 | & (Ampersand)                   |
| 27 | 39 | ` (Single Quote)                |
| 28 | 40 | ( (Right / Closing Parenthesis) |
| 29 | 41 | ) (Right / Closing Parenthesis) |
| 2a | 42 | * (Asterisk)                    |
| 2b | 43 | + (Plus)                        |
| 2c | 44 | , (Comma)                       |
| 2d | 45 | - (Minus / Dash)                |
| 2e | 46 | . (Dot)                         |
| 2f | 47 | / (Forward Slash)               |
| 30 | 48 | 0                               |
| 31 | 49 | 1                               |
| 32 | 50 | 2                               |
| 33 | 51 | 3                               |
| 34 | 52 | 4                               |
| 35 | 53 | 5                               |
| 36 | 54 | 6                               |
| 37 | 55 | 7                               |
| 38 | 56 | 8                               |
| 39 | 57 | 9                               |
| 3a | 58 | : (Colon)                       |
| 3b | 59 | ; (Semi-colon)                  |
| 3c | 60 | < (Less Than)                   |
| 3d | 61 | = (Equal Sign)                  |

|    |     |                             |
|----|-----|-----------------------------|
| 3e | 62  | > (Greater Than)            |
| 3f | 63  | ? (Question Mark)           |
| 40 | 64  | @ (AT Symbol)               |
| 41 | 65  | A                           |
| 42 | 66  | B                           |
| 43 | 67  | C                           |
| 44 | 68  | D                           |
| 45 | 69  | E                           |
| 46 | 70  | F                           |
| 47 | 71  | G                           |
| 48 | 72  | H                           |
| 49 | 73  | I                           |
| 4a | 74  | J                           |
| 4b | 75  | K                           |
| 4c | 76  | L                           |
| 4d | 77  | M                           |
| 4e | 78  | N                           |
| 4f | 79  | O                           |
| 50 | 80  | P                           |
| 51 | 81  | Q                           |
| 52 | 82  | R                           |
| 53 | 83  | S                           |
| 54 | 84  | T                           |
| 55 | 85  | U                           |
| 56 | 86  | V                           |
| 57 | 87  | W                           |
| 58 | 88  | X                           |
| 59 | 89  | Y                           |
| 5a | 90  | Z                           |
| 5b | 91  | [ (Left / Opening Bracket)  |
| 5c | 92  | \ (Back Slash)              |
| 5d | 93  | ] (Right / Closing Bracket) |
| 5e | 94  | ^ (Caret / Circumflex)      |
| 5f | 95  | _ (Underscore)              |
| 60 | 96  | ' (Grave Accent)            |
| 61 | 97  | a                           |
| 62 | 98  | b                           |
| 63 | 99  | c                           |
| 64 | 100 | d                           |
| 65 | 101 | e                           |

|    |     |                         |
|----|-----|-------------------------|
| 66 | 102 | f                       |
| 67 | 103 | g                       |
| 68 | 104 | h                       |
| 69 | 105 | i                       |
| 6a | 106 | j                       |
| 6b | 107 | k                       |
| 6c | 108 | l                       |
| 6d | 109 | m                       |
| 6e | 110 | n                       |
| 6f | 111 | o                       |
| 70 | 112 | p                       |
| 71 | 113 | q                       |
| 72 | 114 | r                       |
| 73 | 115 | s                       |
| 74 | 116 | t                       |
| 75 | 117 | u                       |
| 76 | 118 | v                       |
| 77 | 119 | w                       |
| 78 | 120 | x                       |
| 79 | 121 | y                       |
| 7a | 122 | z                       |
| 7b | 123 | { (Left/ Opening Brace) |
| 7c | 124 | (Vertical Bar)          |
| 7d | 125 | } (Right/Closing Brace) |
| 7e | 126 | ~ (Tilde)               |
| 7f | 127 | DEL (Delete)            |



## Unicode Key Maps

|    |    |    |    |    |    |    |    |    |    |    |    |    |    |    |    |    |    |    |    |    |
|----|----|----|----|----|----|----|----|----|----|----|----|----|----|----|----|----|----|----|----|----|
| 6E | 70 | 71 | 72 | 73 | 74 | 75 | 76 | 77 | 78 | 79 | 7A | 7B | 7C | 7D | 7E | •  | •  | •  |    |    |
| 01 | 02 | 03 | 04 | 05 | 06 | 07 | 08 | 09 | 0A | 0B | 0C | 0D | 0F | 4B | 50 | 55 | 5A | 5F | 64 | 69 |
| 10 | 11 | 12 | 13 | 14 | 15 | 16 | 17 | 18 | 19 | 1A | 1B | 1C | 1D | 4C | 51 | 56 | 5B | 60 | 65 | 6A |
| 1E | 1F | 20 | 21 | 22 | 23 | 24 | 25 | 26 | 27 | 28 | 29 | 2B |    |    |    | 5C | 61 | 66 |    |    |
| 2C | 2E | 2F | 30 | 31 | 32 | 33 | 34 | 35 | 36 | 37 | 39 |    |    | 53 |    |    | 5D | 62 | 67 | 6C |
| 3A | 3B | 3C | 3D |    |    |    |    | 3E | 3F | 38 | 40 | 4F | 54 | 59 | 63 | 68 |    |    |    |    |

**104 Key U.S. Style Keyboard**

|    |    |    |    |    |    |    |    |    |    |    |    |    |    |    |    |    |    |    |    |    |
|----|----|----|----|----|----|----|----|----|----|----|----|----|----|----|----|----|----|----|----|----|
| 6E | 70 | 71 | 72 | 73 | 74 | 75 | 76 | 77 | 78 | 79 | 7A | 7B | 7C | 7D | 7E | •  | •  | •  |    |    |
| 01 | 02 | 03 | 04 | 05 | 06 | 07 | 08 | 09 | 0A | 0B | 0C | 0D | 0F | 4B | 50 | 55 | 5A | 5F | 64 | 69 |
| 10 | 11 | 12 | 13 | 14 | 15 | 16 | 17 | 18 | 19 | 1A | 1B | 1C | 2B | 4C | 51 | 56 | 5B | 60 | 65 | 6A |
| 1E | 1F | 20 | 21 | 22 | 23 | 24 | 25 | 26 | 27 | 28 | 29 | 1D |    |    |    | 5C | 61 | 66 |    |    |
| 2C | 2D | 2E | 2F | 30 | 31 | 32 | 33 | 34 | 35 | 36 | 37 | 39 |    |    | 53 |    | 5D | 62 | 67 | 6C |
| 3A | 3B | 3C | 3D |    |    |    |    | 3E | 3F | 38 | 40 | 4F | 54 | 59 | 63 | 68 |    |    |    |    |

**105 Key European Style Keyboard**

## Newland Auto-ID Tech. Co., Ltd. (Headquarter)

Add: No.1, Rujiang West Rd., Mawei, Fuzhou, Fujian 350001, China  
Tel: +86 (0) 591 8397 9500  
Fax: +86 (0) 591 8397 9216  
E-mail: [info@nlscan.com](mailto:info@nlscan.com)  
Web: [www.newlandaidc.com](http://www.newlandaidc.com)

### Newland APAC

#### Newland Taiwan Inc.

Add: 7F-6, No. 268, Liancheng Rd., Jhonghe Dist. 235, New Taipei City, Taiwan  
Tel: +886 2 7731 5388  
Fax: +886 2 7731 5389  
Email: [info@newland-id.com.tw](mailto:info@newland-id.com.tw)  
Web: [www.newland-id.com.tw](http://www.newland-id.com.tw)

#### Newland Japan

Tel: +886 2 7731 5388 ext. 71  
Email: [info@nlscan.com](mailto:info@nlscan.com)  
Web: [www.newlandaidc.com/jp/](http://www.newlandaidc.com/jp/)

#### Newland Korea

Add: Biz. Center Best-one, Jang-eun Medical Plaza 6F, Bojeong-dong 1261-4, Kihung-gu, Yongin-City, Kyunggi-do, South Korea  
Tel: +82 10 8990 4838  
Fax: +82 70 4369 0009  
Email: [info@nlscan.com](mailto:info@nlscan.com)  
Web: [www.newlandaidc.com/kor/](http://www.newlandaidc.com/kor/)

#### Newland India

Add: 814, Tower B, NOIDA ONE business park B-8, Sector 62, Noida, Uttar Pradesh-201301  
Tel: +91 120 7964266  
Email: [info@nlscan.com](mailto:info@nlscan.com)  
Web: [www.newlandaidc.com](http://www.newlandaidc.com)

### Newland EMEA

#### Newland Europe BV

Add: Rolweg 25, 4104 AV Culemborg, The Netherlands  
Tel: +31 (0) 345 87 00 33  
Fax: +31 (0) 345 87 00 39  
Email: [sales@newland-id.com](mailto:sales@newland-id.com)  
Tech Support: [tech-support@newland-id.com](mailto:tech-support@newland-id.com)  
Web: [www.newland-id.com](http://www.newland-id.com)

### Newland NALA

#### Newland North America Inc.

Add: 46559 Fremont Blvd., Fremont, CA 94538, USA  
Tel: +1 510 490 3888  
Fax: +1 510 490 3887  
Email: [info@nlscan.com](mailto:info@nlscan.com)  
Web: [www.newlandamerica.com](http://www.newlandamerica.com)

#### Newland Latin America

Tel: +1 (239) 598 0068  
Fax: +1 (239) 280 1238  
Email: [info@newlandla.com](mailto:info@newlandla.com)  
Web: [www.newlandamerica.com](http://www.newlandamerica.com)



Newland Auto-ID Tech. Co., Ltd.